

# **SECTION BENDING MACHINE**

---

## **MC400**

NS: 2018-2068

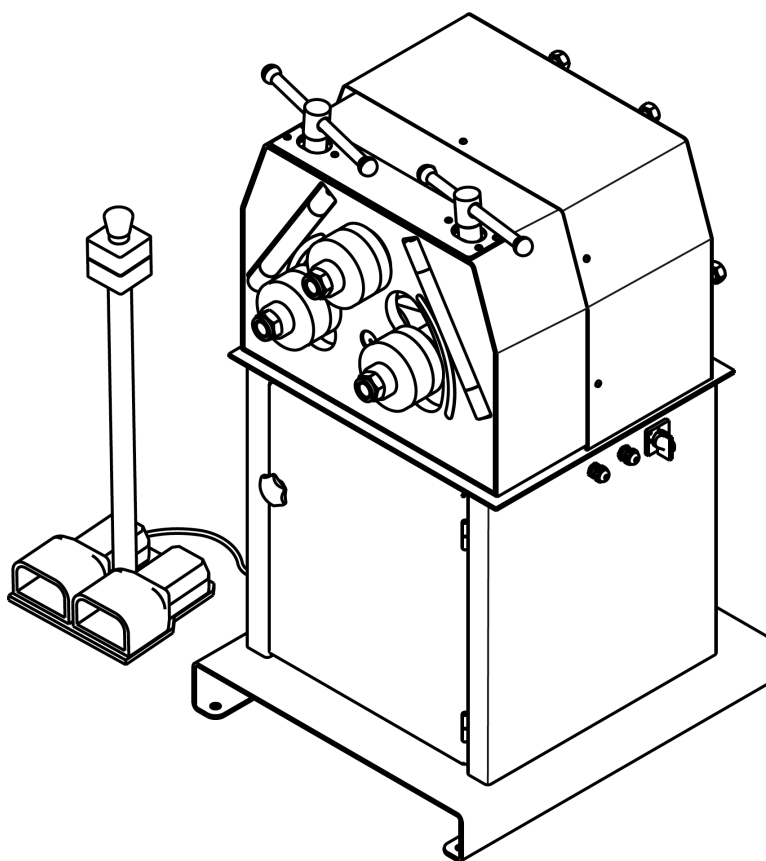

## **INSTRUCTIONS BOOK**

---

**PRADA NARGESA, S.L**

Ctra. de Garrigàs a Sant Miquel s/n · 17476 Palau de Santa Eulàlia (Girona) SPAIN

Tel. +34 972568085 · [nargesa@nargesa.com](mailto:nargesa@nargesa.com) · [www.nargesa.com](http://www.nargesa.com)

## NARGESA CLIENTS

Prada Nargesa has more than 8,000 customers around the world. Some of our clients, those who offer service to third parties with the Nargesa machinery in their workshops, have been pleased to be part of this network that aims to connect them with possible future clients. In this way, all those people or companies that have a need for any part or tool that can be manufactured by using the Nargesa range of machinery, will be able to find a solution in their area to be able to satisfy their production requirements by hiring their services.



### DO YOU WANT TO PARTICIPATE?

Send an email to [nargesa@nargesa.com](mailto:nargesa@nargesa.com), include the following information and we will add you to this list.

We want to encourage all those who haven't participated yet in this great commercial network!

Company name

CIF/Tax Code

City

Country

Machine or machines

## PRADA NARGESA

Prada Nargesa S.L. is a family business founded in 1970 located near Barcelona, Spain, with more than 50 years of experience in the sector of manufacturing of industrial machinery, and more than 10.000m<sup>2</sup> of facilities. Nargesa is a symbol of quality, reliability, warranty and innovation.

Our whole range of machines and accessories is manufactured entirely in Nargesa. We have a constant stock of 400 machines, and we have more than 16.800 machines sold all over the world.



### Ironworker Machines

Ring Roller Bender and Pipe Bender

Non-mandrel Tube and Pipe Bender

Twisting / Scroll Bending Machines

Horizontal Press Brakes

End Wrought Iron Machines

Gas Forges

Iron Embossing Machines

Hydraulic Shear Machines

Hydraulic Press Brakes

Presses for Locks

Broaching Machines

Power Hammers

## CERTIFICATES

Prada Nargesa has several certifications that backup both, the design and manufacturing processes, as well as the journey through exporting our products around the world and the quality of the manufacturing components we use for our machines. These facts turn into real advantages for our customers:



### **AUTHORIZED EXPORTER**

- Faster customs procedures
- Reduction of tariff documentation
- Tariff preferences according to geographical location



### **INNOVATIVE SME**

- Development in innovation, design and manufacturing technologies
- Certification and audit of efficiency in product and service
- Ability to foresee customer needs



### **R+D+I MANAGEMENT**

- Manufacturing based on the R+D+I process
- Technological surveillance system

## SUCCESS STORIES

At Prada Nargesa we believe that the testimony of our clients is our best guarantee, and that is why we like to expose some of the success stories that we have witnessed around the world:

### **PORTUGAL**

Capela & Filhos



### **AUSTRALIA**

Manufactured Alloy Xtras



### **ESTADOS UNIDOS**

Madison Environmental Resources

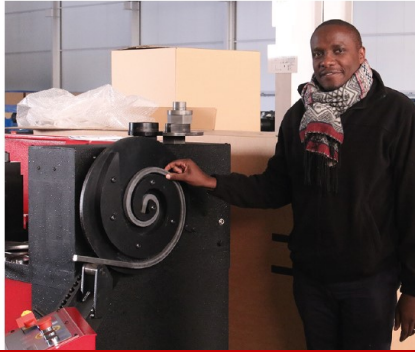
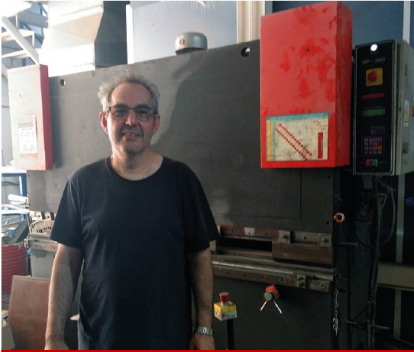

### **ESPAÑA**

CBET Decoración SL

### **UGANDA**

Steel Limited

### **RUMANIA**

Gala Metal & Design SRL

### **DO YOU WANT TO PARTICIPATE?**

Send an email to [nargesa@nargesa.com](mailto:nargesa@nargesa.com) including the following information and we will add you to our website

Company name

Testimonial name

Post in the Company

Country

Descriptive text

Photography with the machine

## INDEX

<b>1. MACHINE INFORMATION</b> .....	3
1.1 Identification of the machine .....	3
1.2 Dimensions .....	3
1.3 Description of the machine .....	3
1.4 Machine part identification .....	4
1.5 General characteristics .....	5
1.6 Description of the guards .....	6
<b>2. TRANSPORT AND STORAGE</b> .....	7
2.1 Transport .....	7
2.2 Storage Conditions .....	7
<b>3. MAINTENANCE</b> .....	8
3.1 Lubrication of moving parts .....	8
<b>4. INSTALLATION AND START UP</b> .....	9
4.1 Positioning the machine .....	9
4.2 Dimensions and work area .....	9
4.3 External permissible conditions .....	9
4.4 Instructions for connecting to the power supply .....	10
<b>5. INSTRUCTIONS FOR THE USAGE</b> .....	11
5.1 Principles to bend .....	11
5.2 Assembling of rollers .....	11
5.3 Traction of the machine axels .....	11
<b>6. ASSEMBLING OF THE ROLLERS</b> .....	12
<b>7. OPTIONAL TOOLING</b> .....	13
<b>8. BENDING CAPACITY</b> .....	15
<b>9. WARNINGS</b> .....	16
9.1. Residual hazards .....	16
9.2 Counter-productive methods .....	16
9.3 Other recommendations .....	16

## TECHNICAL ANNEX

## 1. MACHINE INFORMATION

### 1.1. Identification of the machine

<b>Trademark</b>	Nargesa
<b>Type</b>	Section bending machine
<b>Model</b>	MC400

### 1.2. Dimensions

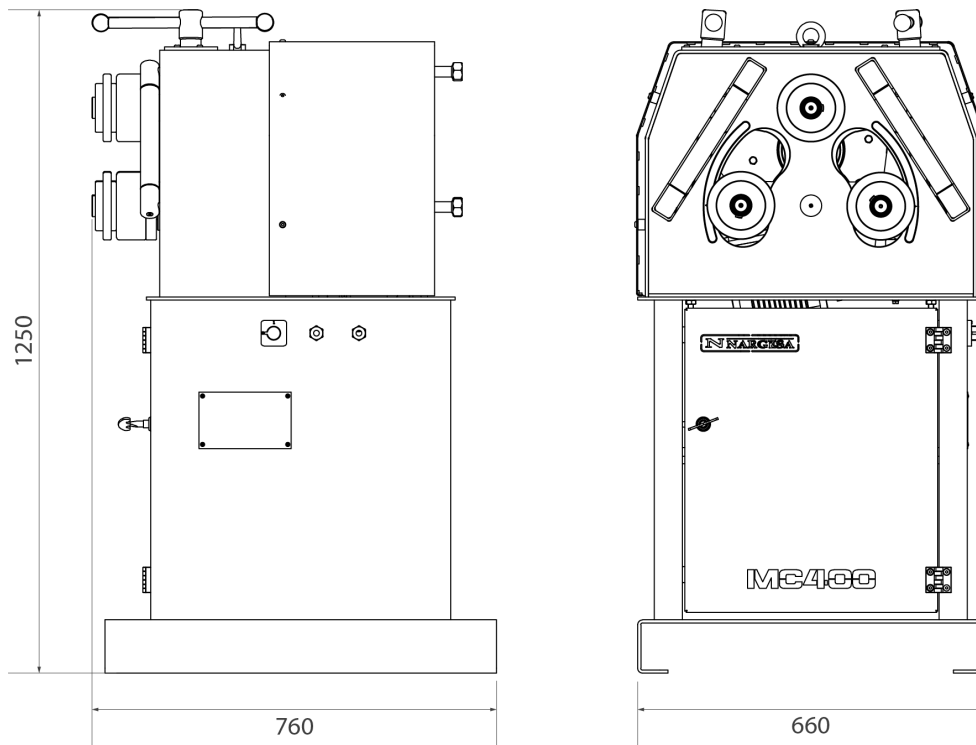

### 1.3. Description of the machine

The MC400 bending machine is a machine specifically designed for bending profiles, the majority of which are metal, with different thicknesses and configurations, such as solid profiles, pipes, T-profiles, angles...

The bending machine offers a set of standard tools, rollers, to allow the bending of profiles in a range of shapes and sizes.

Apart from the standard rollers, the manufacturer also offers different types of additional rollers to produce other types of bending, according to the configuration of the material to be handled, as well as specific rollers for work with stainless steel or aluminium, manufactured with \*SUSTARIN for jobs in stainless steel or aluminum avoiding the material to be damaged or scratched.

\* Sustarín: Polyoxymethylene, high resistance and high rigid crystalline thermoplastic, low friction and excellent dimensional stability

**PRADA NARGESA S.L. is not liable for any damage that might occur due to misuse or failure by users to comply with the safety standards.**



**1.4. Machine part identification**

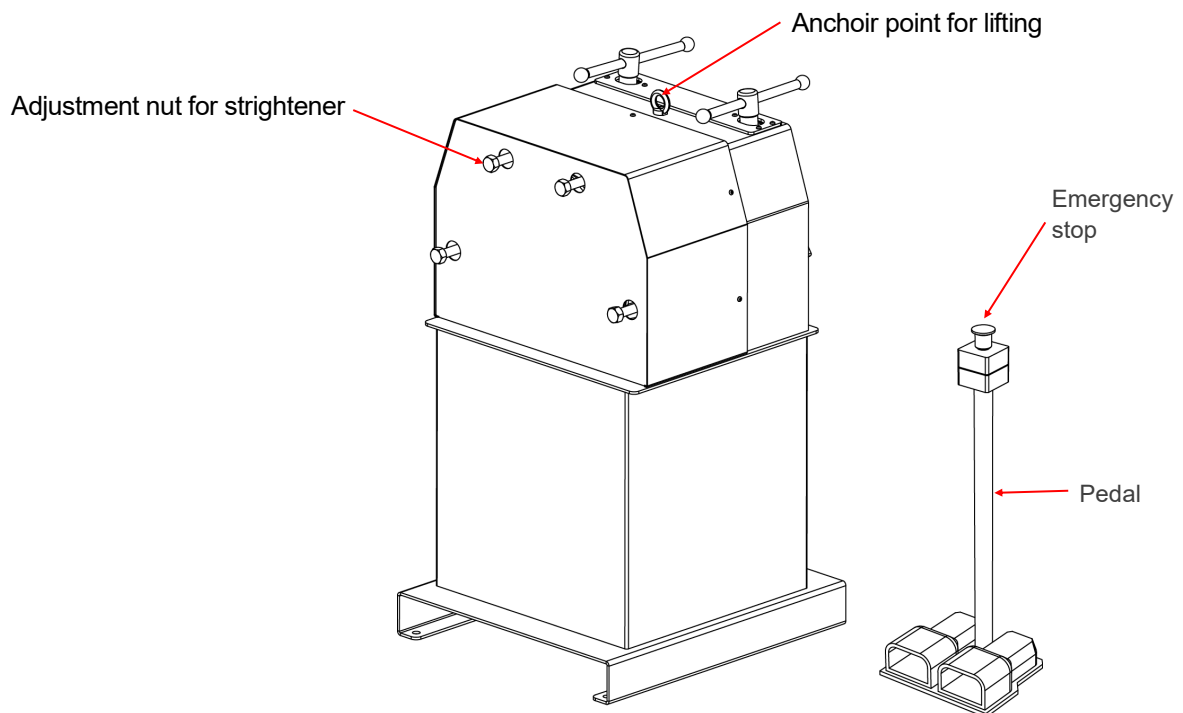
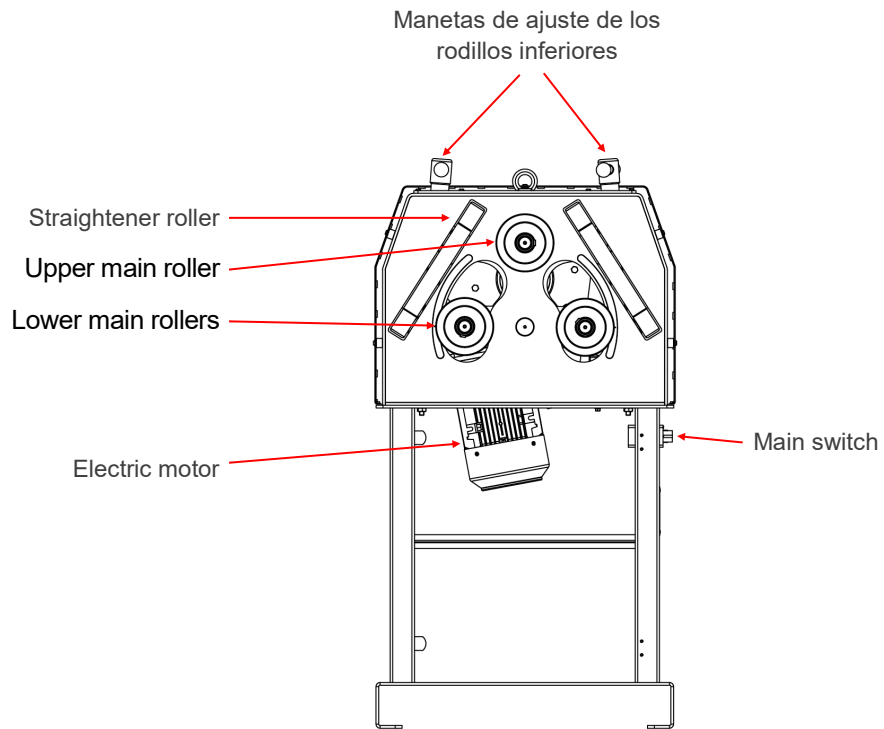



		www.nargesa.com			
PRADA NARGESA, S.L. - CTRA. DE GARRIGAS A SANT MIQUEL S/N 17476 PALAU DE STA. EULALIA (GIRONA) SPAIN - TEL.(+34) 972568085					
TRADEMARK NARGESA			MODEL		
YEAR OF MANUFACTURE			SERIAL N°		
DIMENSIONS		mm.	WEIGHT	Kg.	
POWER	Kw.	INTENSITY	A.	VOLTAGE	V. Hz 50/60

Nameplate

## 1.5. General characteristics

<b>Reference</b>	<b>100-08-01-001</b>
<b>Motor power</b>	1,1 KW / 1,5 CV
<b>Tension</b>	230/400V Three-Phase 50/60 Hz 230V Single-Phase 50/60 Hz
<b>Rollers speed</b>	7 r.p.m.
<b>Diameter of axis</b>	40 mm
<b>Diameter of rollers</b>	130 mm
<b>Useful axes lenght</b>	80 mm
<b>Dimensions</b>	650x740x1260 mm
<b>Weignt</b>	365 Kg

### 1.6. Description of the guards

The gear motor and all the gears that allow the operation of the machine are located under the main upper cover that protects the mechanisms.

Although the major mobile elements are protected by the upper cover, it is necessary to take special precautions during bending operations in order to avoid entrapment between the rollers and the piece being bent.

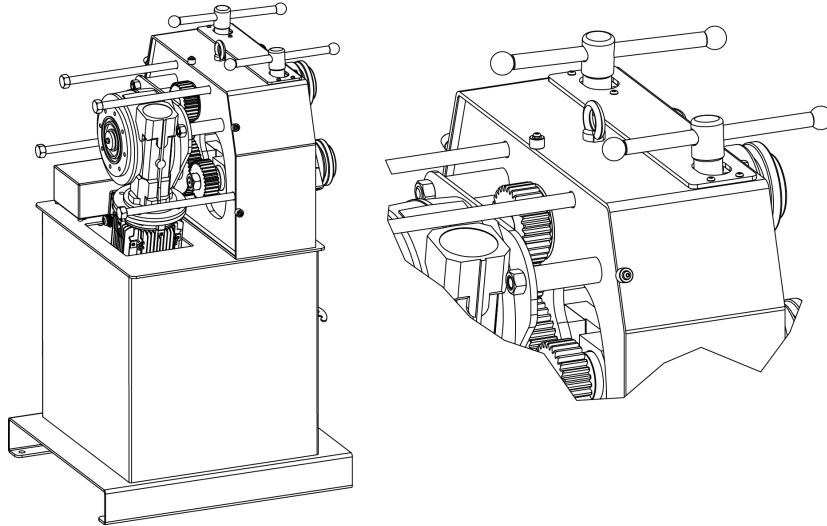

*Mechanism protection guards*

## 2. TRANSPORT AND STORAGE

### 2.1. Transport

There are two ways of carrying out the transportation of the machine:

- From the bottom, through the base of the machine, using a pallet jack or forklift as shown in the illustration. Never raise the machine more than 200 mm from the surface in order to prevent the risk of tipping
- From the top of the machine, from the anchor point designed for this purpose defined in figure 4, using a crane or forklift.

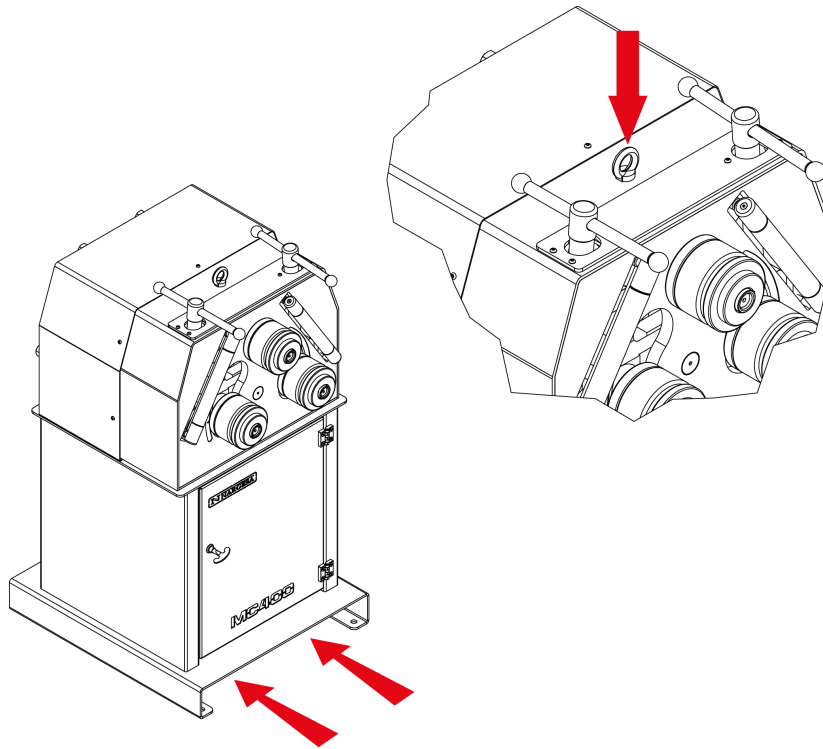

Figure 4. Transportation of the machine

### 2.2. Storage Conditions

The bending machine shouldn't be stored in a place that does not meet the following requirements:

- Humidity between 30% and 95%
- Temperature of -25 °C to 55 °C or 75 °C for periods not exceeding 24hrs (remember that these temperatures are in storage conditions)
- Machines or heavy objects should not be stacked on top

### 3. MAINTENANCE

#### 3.1. Lubrication of moving parts

It is advisable to keep clean the machine moving parts, whenever possible, in order to ensure a correct performance and thus make its useful life longer.

In order to lubricate the moving parts of the machine that require lubrication, it's recommended to follow the next instructions:

- Clean the surface to be lubricated with a cotton cloth or a soft rag that does not release any threads. To remove the accumulated grease and any possible residues that have become stuck to it.
- After cleaning, reapply grease onto the surface with the help of a rag or a spatula.
- Spread the grease evenly without creating excesses or clumps.
- Lubricate the machine regularly, according to use.

*\* It is recommended to use lithium grease for the rollers N.850 EP-2.*

**CAUTION:** The "Emergency Stop" push button must be pressed and the machine brought to a stop in order to lubricate the machine".

## 4. INSTALLATION AND START UP

### 4.1. Positioning the machine

Locate the machine properly in order to avoid moving it; otherwise, follow the guidelines described in the paragraph transport (no. 2). Must be placed on a flat, level surface to prevent it vibrating and moving during bending operations.

It is optional to fix the machine by the four bolts since it is provided with a lower base or stand with four perforations as it's shown in Figure 5.

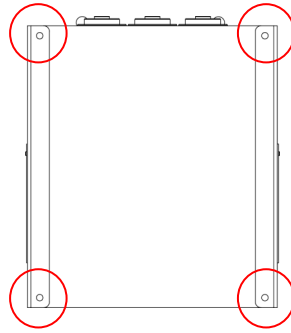

Figure 5. Anchor points of the machine

### 4.2. Dimensions and work area

The dimensions must be considered when the machine is being placed, the working area for the operator and the possible lengths of the parts to be worked.

The bending machine can be used by a single operator, who must be directly in the front of the machine to be able to handle the piece being bent with safety, and never on the side.

Prior to commencing the bending operation, with the machine shut down, the operator must adjust the bending rollers, adapting them to the material and the profile to be bent, as shown in paragraph 7, figure 12.

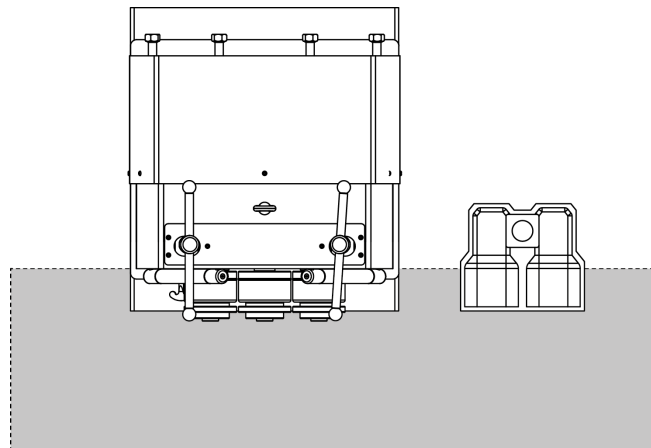

Figure 6. Operator's working area

### 4.3. External permissible conditions

It is advisable to work under the following atmospheric conditions:

- Room temperature between +5 °C and +40 °C without exceeding an average temperature of +35 °C within 24 hrs.
- Humidity between 30% and 90% without water condensation.

### 4.4 Instructions for connecting to the power supply

The machine has a 230/400 V three phased engine, connected in star when the line tension is 400 v and connected in triangle when the three phased line tension is 230 v, as it is indicated below:

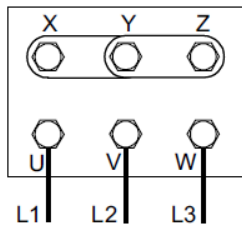

Star figure  
(Default)  
For voltage 400V

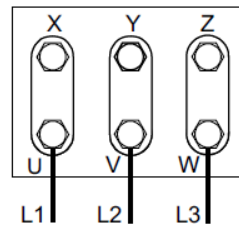

Triangle figure  
For voltage 230V

As well, it is necessary to change the input terminals of the inverter for the change of tension. Input 400V. (Terminals "0" and "400"). Input to 230 V. (Terminals "0" and "230").

In order to detail the procedure, please see the sketch.

**Before making any changes to the wiring of the motor bobbins or electrical panel, it is essential to check that the machine is not connected to any power source.**

## 5. INSTRUCTIONS FOR THE USAGE

### 5.1. Principles to bend

The activation of the machine engine is carried out by using the pedals, one to turn right and the other one to turn left, without nailing in.

It is necessary to get the side rollers up or down in order to regulate the bending radius, and do the same with the vertical rollers in order to achieve the torsion.

Activation pedals have no nailing in. So the machine will stop when the pedal is not pressed.

For the emergency stop, press the pedal emergency button.

The material can be put in the machine for both places. Use the upper handling to adjust the entrance of material. Use the millimeter scale to indicate the position.

Adjust the approximate height to both lateral rollers to get a given radius, (the more you do it, the more experienced you will get).

Adjust the two vertical stand rollers. This will be adjusted by the back part, getting them closer or farther from the profile that has been already set in the rollers. They will help us control the lateral distortion. (They must be adjusted so they get to slightly touch the profile).

If the profile to be worked does not fit in the rollers, it is advisable to cut the extreme to give it a wedge shape, to ease its entrance.

In case the desired results are not achieved, then modify the side rollers position and the vertical ones.

The fastening nuts of the rollers must be only tightened with the hands strength. (no fastening tooling is required to do that).

It is advisable to put some oil in the up and down threads of the rollers whenever necessary to avoid them from getting any hardness.

### 5.2. Assembling of rollers

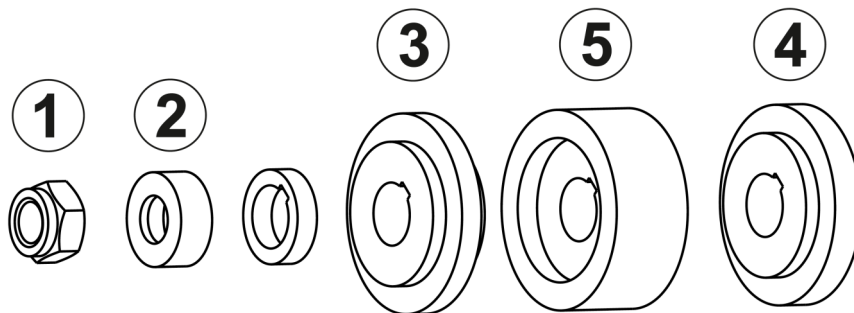

### 5.3. Traction of the machine axels

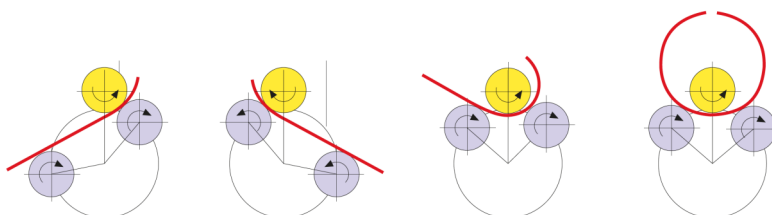



6. ASSEMBLING OF THE ROLLERS

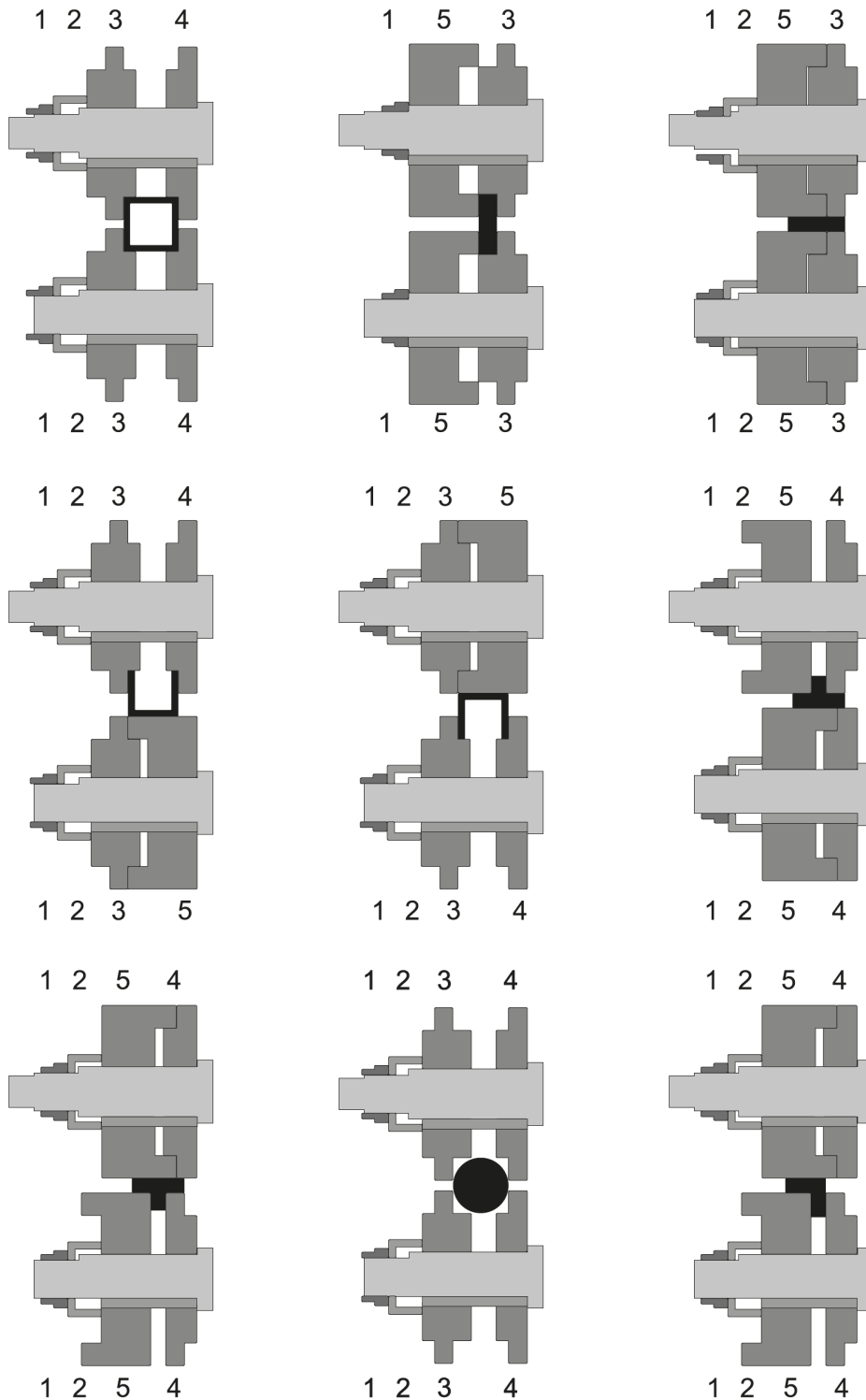

*Nomenclature of the rollers and assembly*

**IMPORTANT NOTE:**

The clamping nut of the rollers should never be tightened with a wrench and only by hand. If pipe rollers are being used, the nuts must be loose.

## 7. OPTIONAL TOOLING

### Set of treated steel rollers



Set of 3 treated steel rollers for steel round pipe or stainless steel, thickness bigger than 2 mm.

When pipe sizes are smaller, two sizes are included in the same roller.

Eg. (25 + 30) o (1/2" + 1"1/4")

*Always clean up the rollers well before using stainless steel not to get the pipe contaminated.*

Tube size in mm		
Reference	Dimensions	Weight
140-08-01-RHT0007	(25 + 30)	17,00 Kg
140-08-01-RHT0006	(20 + 35)	16,50 Kg
140-08-01-RHT0001	40	16,60 Kg
140-08-01-RHT0002	50	14,25 Kg
140-08-01-RHT0003	60	11,10 Kg
For Schedule pipe		
140-08-01-RHISOT0006	(3/4" + 1/2") = (26,9 + 21,3 mm)	17,70 Kg
140-08-01-RHISOT0007	(1" + 3/8") = (33,7 + 17,2 mm)	17,00 Kg
140-08-01-RHISOT0002	1" 1/4 = 42,4 mm	16,00 Kg
140-08-01-RHISOT0003	1" 1/2 = 48,3 mm	14,40 Kg
140-08-01-RHISOT0004	2" = 60,3 mm	11,15 Kg
For inches pipe		
140-08-01-RHWT-00001	(1/2" + 1"1/4") = (12,700 + 31,751 mm)	18,00 Kg
140-08-01-RHWT-00002	(1" + 3/4") = (25,401 + 19,051 mm)	18,50 Kg
140-08-01-RHWT-00003	1"1/2 = 38,101 mm	17,25 Kg
140-08-01-RHWT-00004	2" = 50,802 mm	13,60 Kg
140-08-01-RHWT-00005	2"1/2 = 63,502 mm	9,75 Kg

**Set of Sustarin rollers**



Set of 3 Sustarin rollers for stainless steel pipes, aluminium and delicate materials for thickness smaller than 2.5 mm.

When pipe sizes are smaller, two sizes are included in the same roller.

Eg. (25 + 30)

*Sustarin rollers do not spoil or contaminate the pipe.*

**For any other size or profile please ask the manufacturer.**

Tube size in mm		
Reference	Dimensions	Weight
140-08-01-RI0007	(25 + 30)	1,40 Kg
140-08-01-RI0001	(20 + 35)	1,40 Kg
140-08-01-RI0010	33	1,50 Kg
140-08-01-RI0004	40	1,40 Kg
140-08-01-RI0003	43	1,30 Kg
140-08-01-RI0006	50	1,20 Kg
140-08-01-RI0008	60	0,90 Kg
For inches pipe		
140-08-01-RIW-00001	(1/2" + 1"1/4") = (12,700 + 31,751 mm)	1,80 Kg
140-08-01-RIW-00002	(1" + 3/4") = (25,401 + 19,051 mm)	1,50 Kg
140-08-01-RIW-00003	1"1/2 = 38,101 mm	1,40 Kg
140-08-01-RIW-00004	2" = 50,802 mm	1,20 Kg
140-08-01-RIW-00005	2"1/2 = 63,502 mm	0,90 Kg

## 7.1. Bending capacity



Profile	MC150B		MC200		MC400		MC200H	
	Measures	Min. radius	Measures	Min. radius	Measures	Min. radius	Measures	Min. radius
	50 x 8	300	50 x 10	300	50 x 10	250	60 x 10	200
	60 x 20	200	80 x 20	150	80 x 20	150	80 x 20	150
	25 x 25	200	30 x 30	200	30 x 30	150	30 x 30	150
	40 x 40 x 3	350	50 x 50 x 3	700	50 x 50 x 3	600	50 x 50 x 3	450
	40	200	40	200	40	150	40	200
	40	250	40	250	40	200	40	250
	50	200	60	300	60	225	60	225
	50	250	60	300	60	225	60	225
	40	500	40	420	40	200	40	300
	25	180	30	150	30	150	30	150
	40 x 2 *	300	40 x 2 *	250	40 x 2 *	200	40 x 2 *	200
	50,8 x 3 *	600	63,5 x 3 *	500	63,5 x 3 *	450	76,2 x 2 *	500
	= 2" x 3 *	600	= 2"1/2 x 3 *	500	= 2"1/2 x 3 *	450	= 3" x 2 *	500

\* Optional rollers



MC550 · MC550NC · MC550CNC			MC650 · MC650NC · MC650CNC		
Profile	Measures	Min. radius	Measures	Min. radius	
	60x15	400		100x15	1250
	60x8	200		80x20	450
	50x15	350		60x15	300
50x10	175	50x15		155	
	40x8	150		20x10	140
	30x5	110			
	25x5	105			
	100x20	250	120x20	250	
	80x20	200	100x25	350	
	80x15	180	80x20	200	
	40x40	400	400	300	
	30x30	180	180	280	
	25x25	175	175	200	
	20x20	150	150	150	
	15x15	150	150		
	60x60x3	800	70x70x4	750	
	50x50x3	600	60x60x3	750	
	35x35x3	200	40x40x3	300	
	70x30x3	500	80x40x3	500	
	60x30x3	400	60x30x3	300	
	50x30x3	250	50x30x3	250	
	60x60x7	300	80*	500	
	50x50x6	250	70	400	
	40x40x5	200	60	200	
			40	150	
	60x60x7	500	80*	500	
	50x50x6	400	60	400	
	40x40x5	300	40	150	
	60x60x7	350			
	50x50x6	300	60x8	450	
	40x40x5	250	40x6	250	

SECTION BENDING MACHINE MC400



	MC550 · MC550NC · MC550CNC		MC650 · MC650NC · MC650CNC	
Profile	Measures	Min. radius	Measures	Min. radius
	50x5	750*	50x5	750*
	40x4	500*	40x4	500*
	40	300	50	300
	35	250	40	200
	30	200	25	175
	20	130		
			101,6x3,5* (=4"x3)	500
			100x3*	500
			88,9x4* (=3"SCH)	700
			35x2*	120
			20x1,5*	115

## **9. WARNINGS**

The MC400 bending machine is designed and assembled to allow the operator to handle the machine and bend the necessary parts in a completely safe manner. Any change to the machine's structure or characteristics could modify the safety offered by the machine, breaching the EC certificate of conformity and could endanger the operator.

### **9.1. Residual hazards**

Hazardous conditions may occur during the bending of materials that must be analysed and prevented.

Attention should be paid to the movements of the piece to be bent and the roller while the material is being introduced into the machine as well as during its shaping. Despite the fact that the forward speed of the rollers is slow, there is a risk of entrapment in the extremities between the rollers and the part.

Users of the machine are recommended to handle the part to be bent firmly with one hand and to move the hand according to the progress of the bending operation in order to maintain a safe distance from the rollers.

It is also necessary to prepare the work area to prevent other operators from injuring themselves during operation of the machine.

### **9.2. Counter-productive methods**

Tools or rollers that are not supplied by the manufacturer of the machine, NARGESA S.L., and which have not been specially designed for the MC650 bending machine should never be used .

### **9.3. Other recommendations**

- Use gloves for handling the machine and during the bending processes.
- Wear EC-approved goggles and protective boots
- Handle the material at the ends, and never around the area being bent
- Do not work without the protection devices that the machine is fitted with
- Ensure that there is a safe distance between the machine and the operator



## **Technical annex**

### MC400 Bending Machine

---

General parts diagram







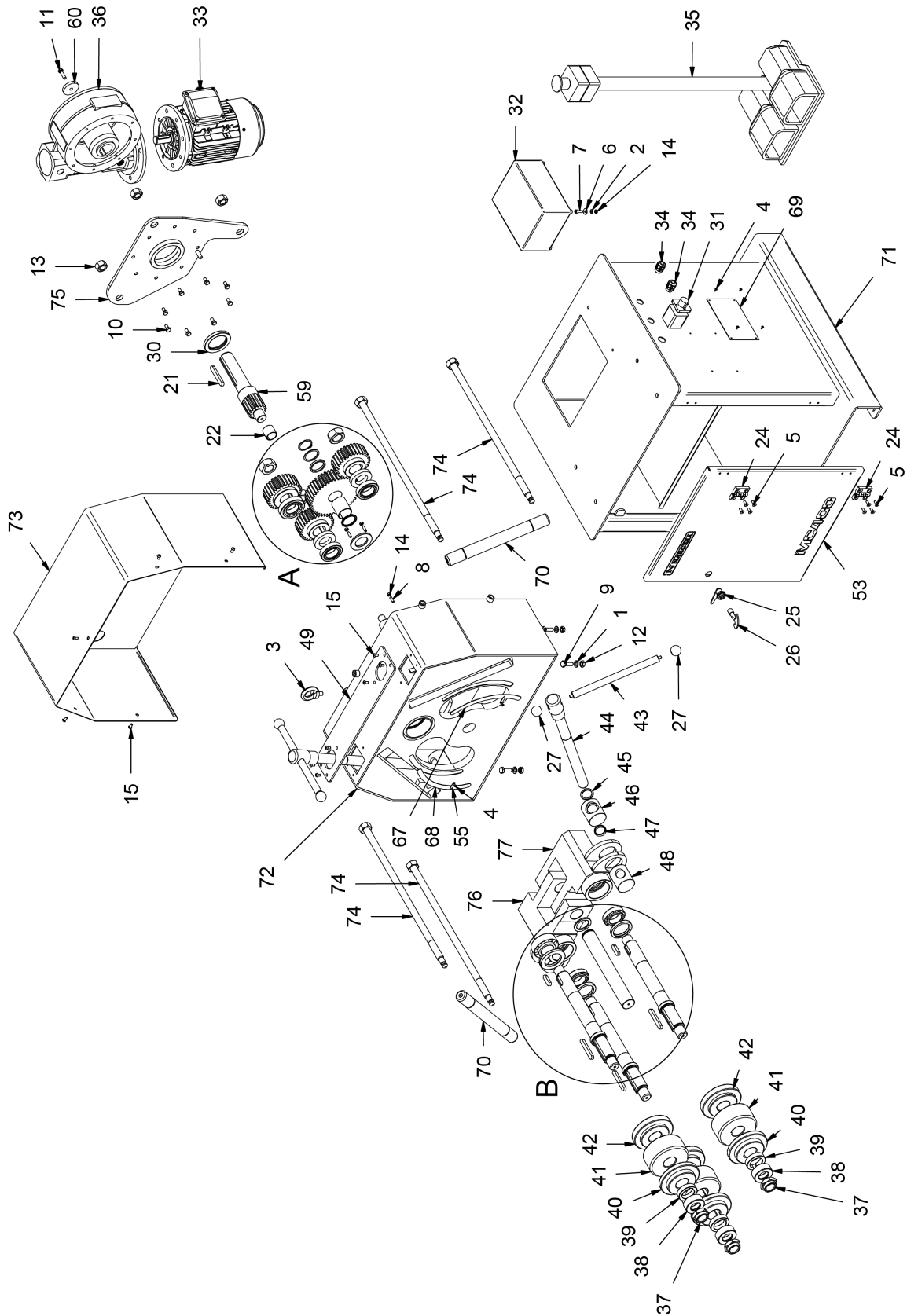

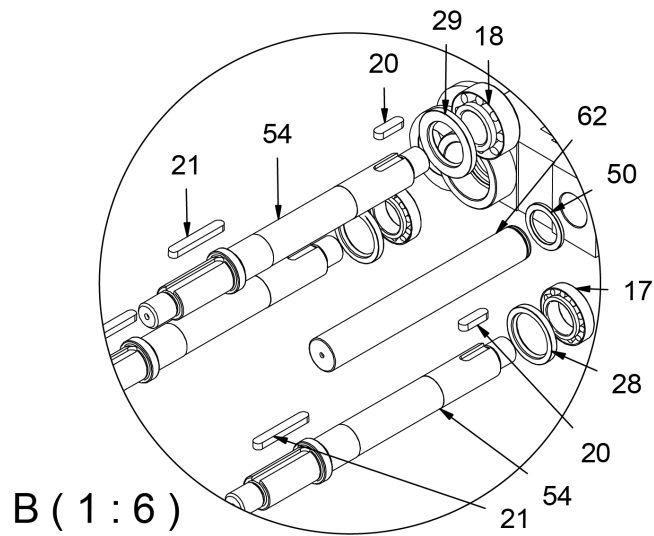
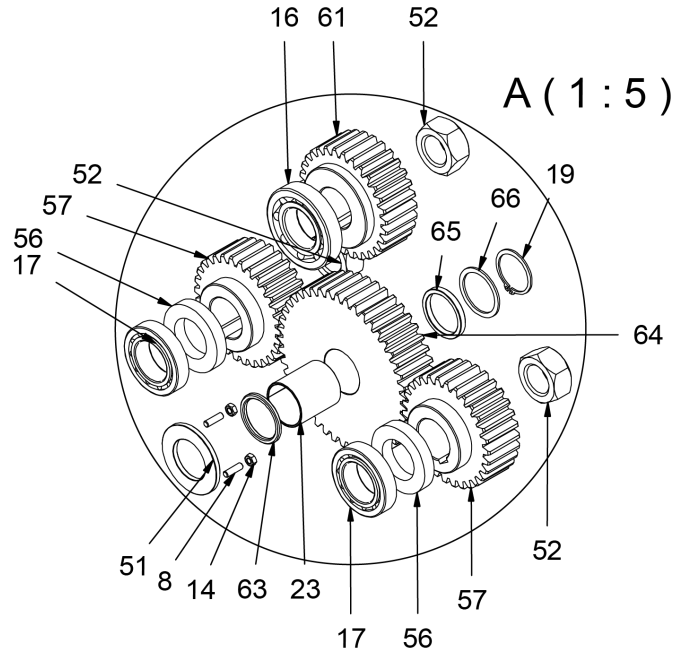









Electric map · THREEPHASE MACHINE

Electric map · SINGLEPHASE MACHINE

















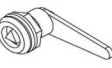

**A1 General parts diagram**





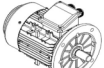





























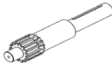

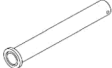

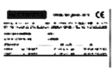
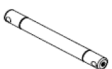

ELEMENTO	MINIATURA	REFERENCIA	DESCRIPCIÓN	CTDAD
1		020-D125B-M10	Arandela Biselada DIN125B Para M10	4
2		020-D125B-M6	ARANDELA BISELADA DIN125B PARA M6	2
3		020-D580-M12-ZN	Cáncamo Macho DIN 580 M12 ZINCADO	1
4		020-D7337-3X8	Remache De Clavo DIN7337 De Al D3X8	6
5		020-D7991-M6X16	Tornillo Allen Avellanado DIN 7991 M6X16	8
6		020-D9021-M6	Arandela Ancha DIN9021 Para M6	2
7		020-D912-M6X20	Tornillo Allen DIN912 M6X20	2
8		020-D913-M6X20	ESPARRAGO ALLEN DIN 913 M6X20	3
9		020-D933-M10X30	TORNILLO HEXAGONAL DIN 933 M10X30	4
10		020-D933-M8X16	TORNILLO HEXAGONAL DIN 933 M8x16	8
11		020-D933-M8X30	Tornillo Hexagonal DIN 933 M8x30	1
12		020-D934-M10	Tuerca Hexagonal DIN934 M10	4
13		020-D934-M20	Tuerca Hexagonal DIN 934 M20	3
14		020-D934-M6	Tuerca Hexagonal DIN934 M6	5
15		020-D7991-M6X12	Tornillo Allen Avellanado DIN7991 M6X12	2
15		020-I7380-M6X12	Tornillo Allen Abombado ISO7380 M6X12	11
16		030-CJ-00001	Rodamiento De Rodillos DIN720 30208 40X80X19.75	1
17		030-CJ-00002	Rodamiento de rodillos cónico 32008 40x68x19	4

**SECTION BENDING MACHINE MC400**

18		030-CJ-00007	Rodamiento de rodillos cónico 33208 40X80X32	1
19		030-D471-00005	CIRCLIP EJE DIN 471 D40	1
20		030-D6885A-00003	CHAVETA PARALELA DIN 6885A 12X8X40	3
21		030-D6885A-00006	CHAVETA PARALELA DIN 6885A 12X8X80	4
22		030-DP-00013	Dolla Partida SD-1 D30XD34X30 Plateada	1
23		030-DP-00017	DOLLA PARTIDA D40XD44X50	1
24		031-BP-00001	BISAGRA DE PLASTICO 30 ENTRE CENTROS	2
25		031-CLT-00001	CIERRE DE LENGÜETA CON TRIANGULO 8 M20	1
26		031-LLT-00001	LLAVE PARA CIERRE TRIANGULO DE 8 FLOTANTE NIQUELADA	1
27		031-POMH-00004	Pomo Esfera Ranurada Ø32 M8 Con Inserto Metalico	4
28		040-RET-00001	RETEN D50XD68D8	2
29		040-RET-00002	RETEN D50XD80X8	1
30		040-RET-00003	Reten D60XD85X10	1
31		050-IG-00002	INTERRUPTOR GENERAL	1
32		050-KIE-0801-001	KIT INSTALACION ELECTRICA MC400	1
33		050-ME-00002	MOTOR ELECTRICO 1.1 Kw a 900 rpm BRIDA B5	1
34		050-PE-00003	Prensaestopa GFPT 212 50043 M20X150 PG13.5	2
35		050-PED-00002	Pedal Doble Con Paro De Emergencia	1
36		050-RT-00003	Reductor Mrs110Fo Sin Brida 1:80 Iec90B5 Marca VARVEL FRS110 MC400	1

37		120-08-01-00001	Tuerca Posterior	3
38		120-08-01-00002	Arandela de Vaso	3
39		120-08-01-00003	Arandela Grueso Rodillo	3
40		120-08-01-00004	Rodillo de 40 mm	3
41		120-08-01-00005	Rodillo de 55 mm	3
42		120-08-01-00006	Rodillo de 30 mm	3
43		120-08-01-00008	Maneta	2
44		120-08-01-00009	Eje Soporte Roscado	2
45		120-08-01-00010	Arandela de Bronce Rosca Larga	2
46		120-08-01-00011	Soporte Superior Rosca Larga	2
47		120-08-01-00012	Anillo Tope	2
48		120-08-01-00013	Soporte Inferior Rosca Larga	2
49		120-08-01-00014	Sufridera Accionamiento Bujes MC400	1
50		120-08-01-00023	Arandela Frontal de Nivelación	1
51		120-08-01-00039	Arandela de Bronce Rosca Larga	1
52		120-08-01-00043	Tuerca Posterior	3
53		120-08-01-00047	PUERTA MC400	1
54		120-08-01-00063	Eje Rodillos	3
55		120-08-01-00065	Flecha Posicion Bujes MC400	2
56		120-08-01-00069	Arandela Piñon MC400	2

**SECTION BENDING MACHINE MC400**

57		120-08-01-00070	Piñón Z30 M3.5 L55	2
59		120-08-01-00077	Eje Piñón Principal Z15 M3.5	1
60		120-08-01-00081	Arandela Fijacion Eje Reductor MC400	1
61		120-08-01-00088	Piñón Z30 M3.5 Eje Central	1
62		120-08-01-00089	Eje Central	1
63		120-08-01-00090	GRUESO BRONCE PIÑON CENTRAL	1
64		120-08-01-00092	ENGRANAJE Z45 REENVIO	1
65		120-08-01-00093	Arandela De Bronce	1
66		120-08-01-00106	Arandela Trasera Eje Central D49XD40.2X2	1
67		122-08-01-00020	Regla Milimetrada en Arco Serigrafiada Lado Derecho	1
68		122-08-01-00021	Regla Milimetrada en Arco Serigrafiada Lado Izquierdo	1
69		122-PLC-0000-001	Placa Caracteristicas General	1
70		130-08-01-00001	RODILLO AJUSTE VERTICAL	2
71		130-08-01-00100	Chasis	1
72		130-08-01-00101	Estructura Caja	1
73		130-08-01-00102	Conjunto Tapa Trasera MC400	1
74		130-08-01-00103	Nivelador Rulina	4
75		130-08-01-00104	Soporte Tapa Reductor	1
76		130-08-01-00105	Conjunto Basculante Izquierdo	1
77		130-08-01-00106	Conjunto Basculante Derecho	1



A2 Electric map · THREEPHASE MACHINE

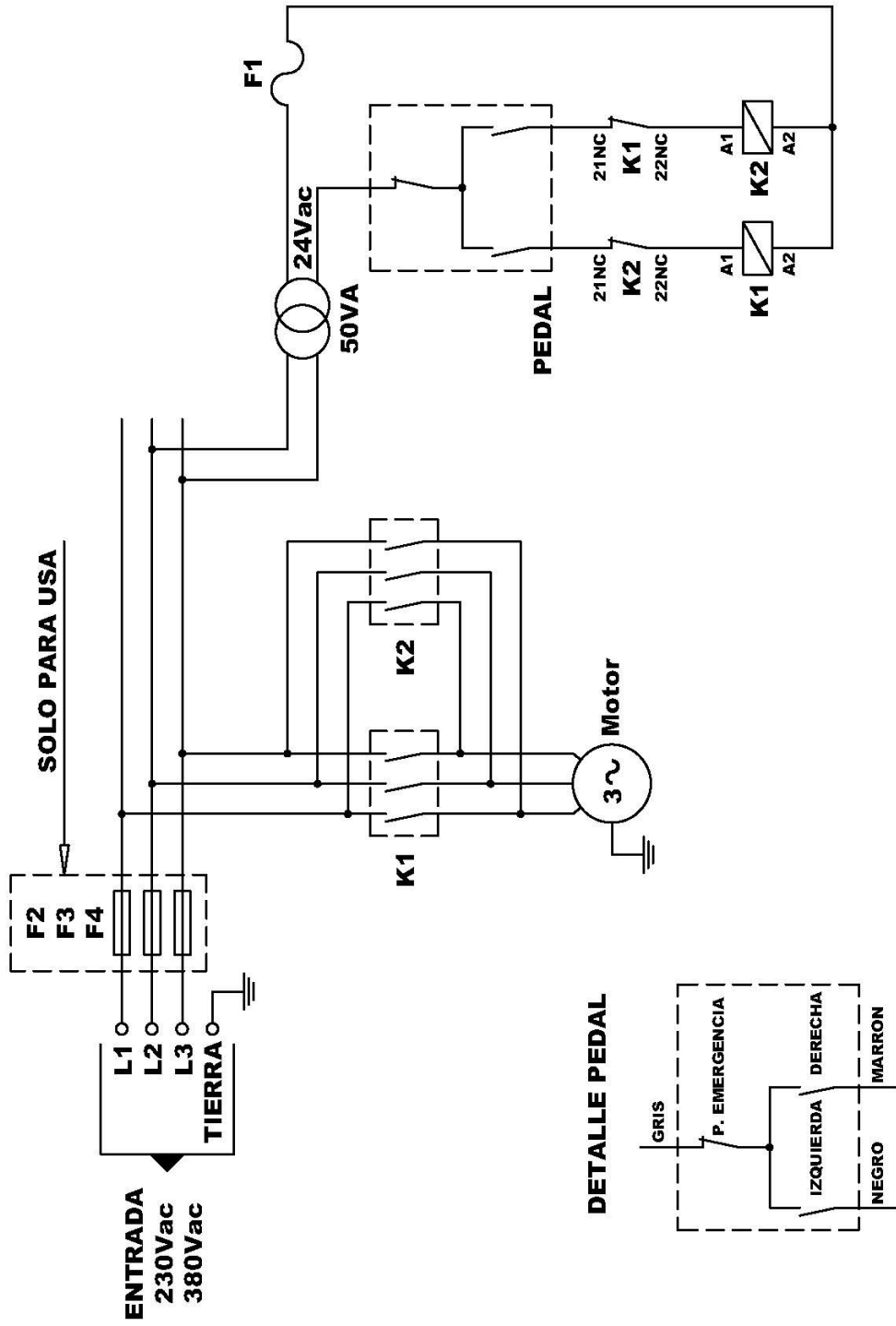

A3 Electric map · SINGLEPHASE MACHINE

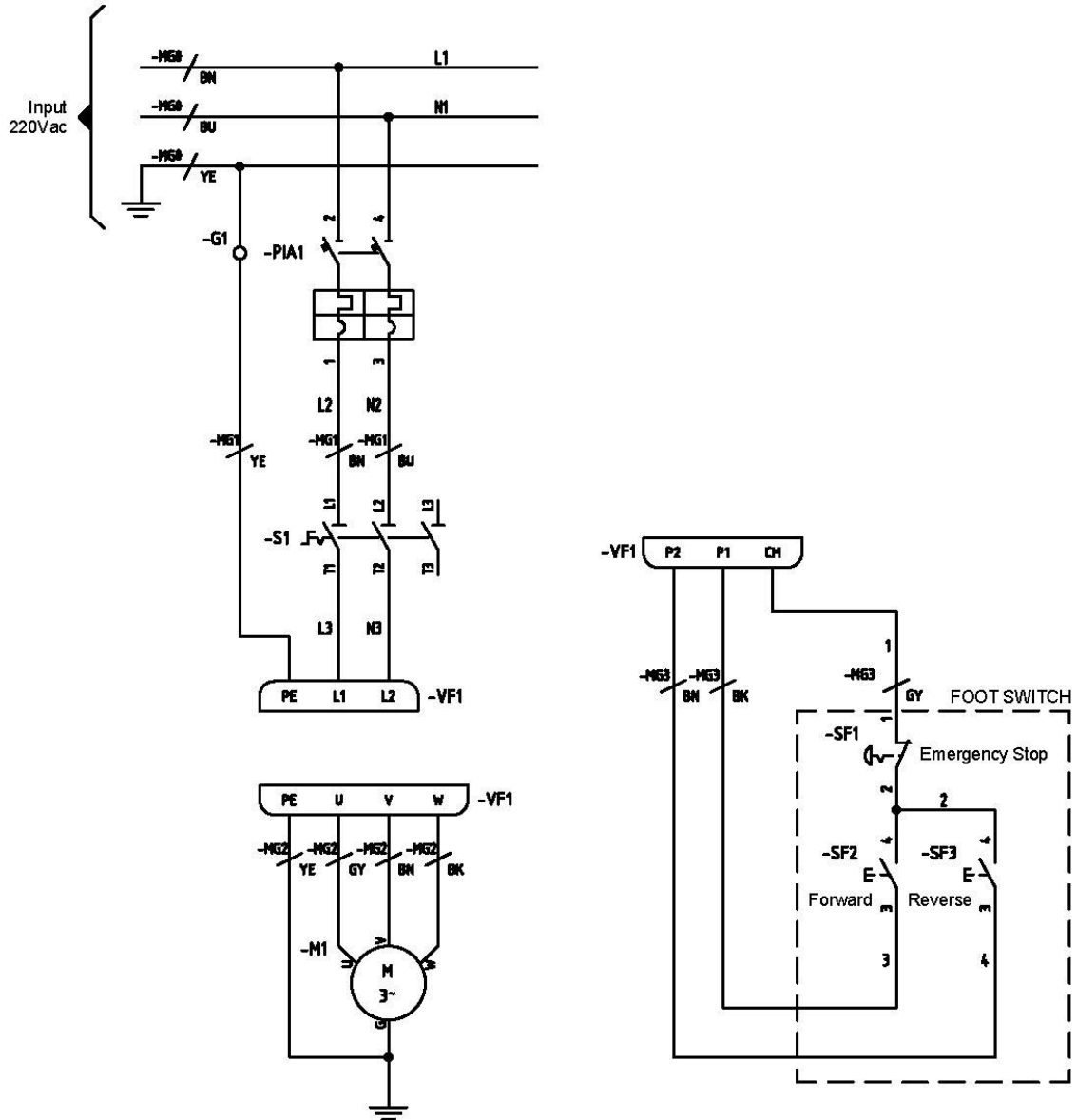

# OUR RANGE OF MACHINERY

---



IRON WORKERS



SECTION BENDING  
MACHINES



NON-MANDREL  
PIPE BENDER



HORIZONTAL PRESS  
BRAKE



TWISTING/SCROLL  
BENDING MACHINES



HYDRAULIC PRESS  
BRAKES



HYDRAULIC SHEAR  
MACHINES

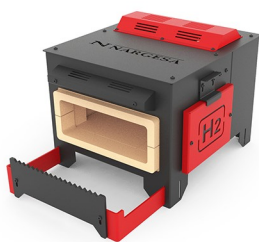

GAS FORGES



IRON EMBOSSING  
MACHINES



END WROUGHT IRON  
MACHINES



BROACHING  
MACHINES



POWER HAMMERS



PRESSES FOR LOCKS