

# LASER WELDING EQUIPMENT

## MS20

 4.0 Technology

**NEW**



**50** years  
manufacturing industrial machinery



**AENOR**

R&D&I  
MANAGEMENT

UNE16602

## HOW IT WORKS VIDEO

Video on how the machine works



## GET A QUOTE

Please complete the following form. We'll contact you in less than 24 hours.

*Business days*

## SOME OF OUR CUSTOMERS

Our customer's endorsement is our best business card



## CERTIFICATES AND ACCREDITATIONS

Some of the certificates that support our processes and benefit our customers



Valid until May 31st 2026



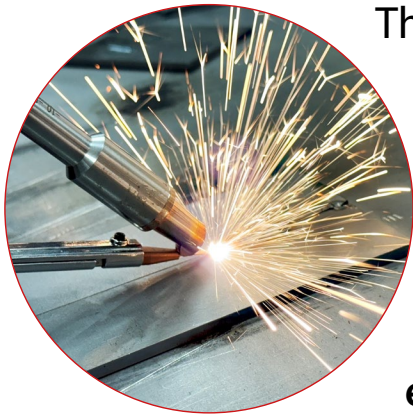

The **Nargesa MS20 Laser Welder**, with a power of **2000W**, represents a significant breakthrough in laser welding technology. It performs laser cutting, welding and cleaning in a single compact and efficient unit. **There is no complex learning curve and no need to be an expert welder.**

Its **extreme precision, high speed and ease of use** make it the most cost-effective welding process, not only for manual work but also for **robotic automation**.

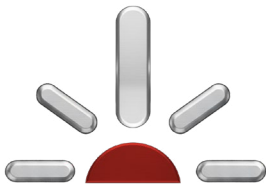

### **Leading fusion depth**

This unit offers the greatest weld bead depth on the market, reaching up to 6 mm in carbon steel and stainless steel and 5 mm in aluminum.



### **Manufactured 100% in Spain**

The MS20 has been designed, manufactured, assembled and tested at our facilities in Spain.

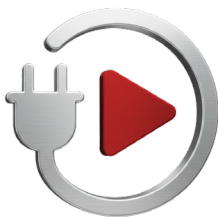

### **Intuitive interface and Plug & Play delivery**

Its intuitive interface and low-complexity operation mean that, with minimal training, the machine can be operated quickly and safely by non-specialised staff. It is shipped with basic parameters preconfigured, ready to plug in and start working.



### **Expert, free and unlimited technical support**

100% personalised technical support service, at no additional cost and with no limits. With 4.0 technology, we connect remotely to the MS20 to adjust parameters, perform updates or assess any unusual situation.

# TECHNICAL FEATURES

- > **Power:** 2000 W / 2 kW
- > **Voltage:** 220 / 240 V. Single-phase.
- > Frequency: 50 / 60 Hz
- > **Wavelength:** 1080 nm
- > **Fusion penetration depth:** 6 mm in carbon steel and stainless steel and 5 mm in aluminum.
- > **Cutting capacity:** 4 mm
- > **Fiber hose length:** 10 m / 393.7"
- > **Fiber diameter:** 25  $\mu$ m
- > **Guide laser:** 630–650 nm / 0.5–1 mW
- > **Maximum laser beam opening:** 5 mm / 0.2" Single Wire Feed – 8 mm / 0.31" Double Wire Feed
- > **Power consumption:** 4 kW
- > **Maximum amperage:** 16 A
- > **Cooling method:** Distilled water
- > **Working modes:** Welding, cutting and cleaning
- > Highly intuitive 7" ESA S820 touch CNC control panel
- > Alarm diagnostics
- > 4.0 technology
- > Metric and inch control
- > Temperature control in degrees Celsius and Fahrenheit
- > Resonator status control via Bluetooth
- > Maximum wire capacity: 2 coils of 2 mm / 0.079"
- > **Spool capacity:** 2 units of 15 kg,  $\varnothing$ 300 mm / 33 lb 11.81"
- > Built-in interior LED light
- > Possibility to work with two coils of same or different wire
- > **Number of wire feeders:** 2 units
- > **Number of motorised drive rollers:** 8 units
- > **Cleaning range:** 0 to 14mm / 0" to 0,55"
- > Built-in signal tower light
- > **WSX laser torch with LED and latest-generation ergonomic grip:** one- or two-hand grip
- > Raycus resonator, European leader in laser components.
- > Connection between hose and torch with flexion spring
- > Single hose with all components integrated
- > Protected and magnetised torch holder
- > Holder for Argon or Nitrogen cylinders included
- > Drawer for consumables, tools and spare parts
- > **Plug & Play delivery:** The machine is shipped fully assembled and ready to start working
- > **Predefined parameters:** Each unit is delivered with the basic operating parameters tested and configured
- > **Ease of use:** With the Nargesa video tutorial, you can operate it easily from day one
- > Wooden pallet and triple-layer cardboard box suitable for sea freight
- > **Optional:** NIMF15 wooden packaging

---

*The Nargesa MS20 Laser Welding Machine complies with **European CE regulations** for industrial machinery safety and manufacturing, as well as with the **requirements of the U.S. FDA** for laser equipment.*

---

# WHAT SETS US APART

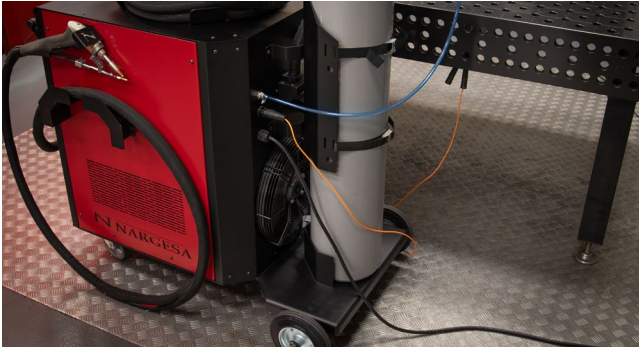

## Safety and mobility: Built-in gas cylinder holder

Most laser welding machines on the market do not include integrated holders for gas cylinders such as argon or nitrogen. This omission not only makes transporting the equipment more difficult, but also represents a major safety risk for the operator. Without proper securing, cylinders can easily tip over, even when the machine is in a fixed position, creating hazardous situations in the work environment. Having a solution that ensures the stability and mobility of the complete system is essential for safe, efficient and professional operation.



## Integrated storage drawer for maximum efficiency

The machine features a built-in drawer in the chassis, specially designed to store consumables, wrenches and accessories in a clean, safe and organised way. This solution allows the operator to have everything needed within easy reach, avoiding unnecessary movements and improving efficiency in daily work. Every detail has been designed to offer a practical, professional and fully autonomous user experience.



## Industry 4.0 technology

The advantages of having this technology in a machine are endless, but we will focus on the most relevant ones. Provided the customer gives their consent, the manufacturer can remotely connect to the machine to perform any software updates completely free of charge and detect possible anomalies without needing to be on-site. It notifies the customer when preventive maintenance must be carried out on the machine, among many other functions.

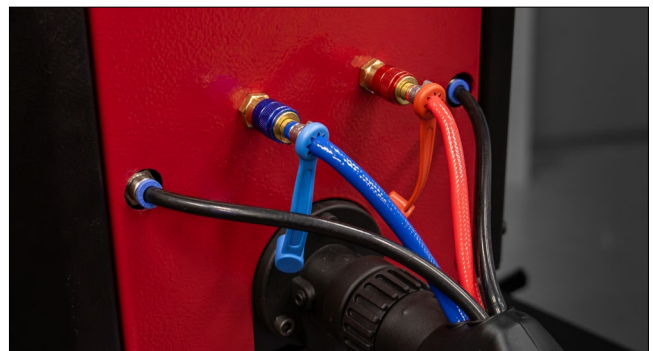

## Water cooling

It ensures consistent performance even during long periods of intensive work. This system is especially crucial in automatic or robotic mode, where continuity and thermal stability are essential. A good cooling system not only extends the service life of the components, but also guarantees more precise, interruption-free welding, optimising overall process efficiency.



### High-performance wire feeding system

The MS20 laser welding unit is equipped with an advanced dual rotating feeder system with four motorised rollers, designed to provide precise and constant wire traction, especially in critical applications such as aluminium and stainless-steel welding. Unlike many units on the market that only motorise the lower rollers, the MS20 features eight motorised rollers, ensuring uniform, slip-free feeding even with demanding materials.

This model allows the installation of two 15 kg coils, with wire diameters up to 2 mm (0.079"), and the ability to work with two different wire types or sizes (for example, stainless steel and carbon steel) without the need for mechanical changes.

This eliminates setup times and allows instant wire changes, significantly increasing productivity.

The versatility of the MS20 is also reflected in its operational design: the feeder can be mounted on the machine, hung from a jib arm, or moved independently thanks to its wheeled base, easily adapting to different working configurations. In addition, it includes internal LED lighting, improving visibility in low-light environments and making maintenance and adjustment tasks easier.

The MS20 handheld laser welder redefines welding efficiency, combining power, precision and flexibility in a single solution for demanding industrial environments.

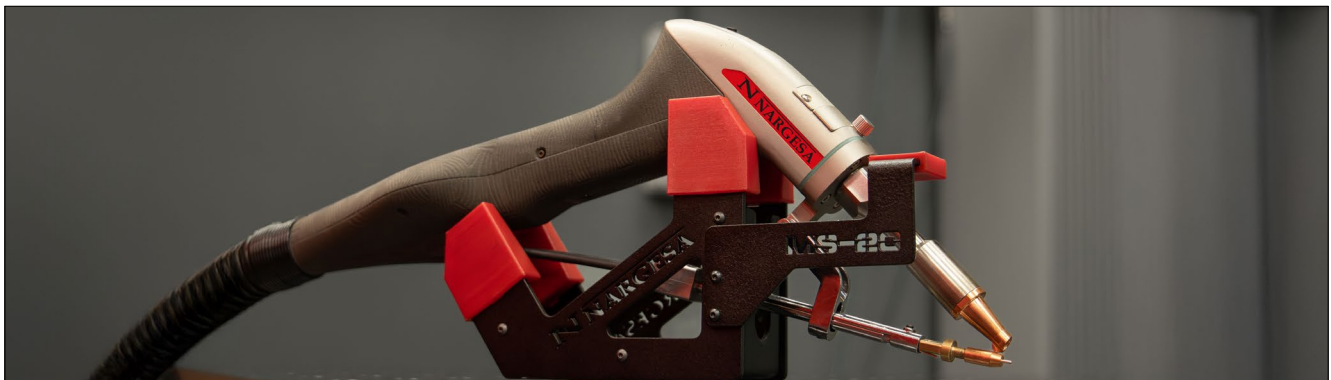

### Latest-generation ergonomic torch

Welding torch has been designed to offer maximum comfort, precision and durability in highly demanding environments. It features an ergonomic grip that compactly integrates the optical fibre, cooling hoses and two wire liners, all connected by a flexible spring that provides greater freedom of movement and comfort during prolonged use.

Unlike other solutions on the market, all conduits and components are protected by a single outer

hose, which improves manoeuvrability, reduces wear and makes it easier to work in confined spaces. It also includes an alarm LED integrated directly into the torch, providing an immediate visual signal in the event of any failure or critical condition.

Thanks to its compact design, ultra-light weight and excellent balance, it can be handled effortlessly with one or two hands, making it the ideal tool for precision work and long operating shifts.

# WE OFFER YOU A **COMPLETE SOLUTION**

At Nargesa, we do not simply supply a laser welding unit.  
We work with you to design the entire welding project so that you have a complete, safe and productive solution that is ready to grow.

Based on your parts, volumes and current processes, our technical team proposes a customised project, tailored to your reality and your objectives:



MS20 laser welder as the core of the process, configured with the appropriate parameters and accessories for your materials and thicknesses.



Universal Robots cobot, the world's leading brand in collaborative robotics, to automate the welding operation, improve repeatability and reduce cycle times.



Certified welding cell, designed and approved in accordance with European safety standards, with all protection elements and full electrical and control integration.



Siegmund welding table, a benchmark in the sector, to ensure maximum accuracy in part positioning and speed up tooling changeovers.

The result is a **turnkey laser welding system**, where every component works in harmony with the rest. From the initial study to commissioning and operator training, Nargesa ensures that you have a comprehensive solution that increases your productivity, improves the quality of your weld beads and reduces your dependence on expert welders.

# Characteristics that set us apart as a manufacturer of industrial machinery

We are a family-owned company with more than 50 years of experience, and we take operator safety and maximum profitability for the companies that trust our brand very seriously.

## **1** Robust, long-lasting design

Our machines are built with industrial-grade materials that guarantee a long service life, even in demanding environments.

## **2** Tailor-made customisation

We adapt each unit to the specific processes of our customers, optimising productivity and operational efficiency.

## **3** Cutting-edge technology

We incorporate automation systems, smart sensors and digital control to improve performance and reduce downtime.

## **4** Local manufacturing with international standards

We are a national manufacturer with certified quality under ISO standards and full compliance with CE or equivalent regulations.

## **5** Specialised, free and unlimited technical support

We offer technical assistance with highly qualified staff, both on-site and remotely. Thanks to 4.0 technology, we can connect remotely to your MS20 Laser Welder to assess any situation.

## **6** Fast delivery and on-time performance

Our production processes are optimised to ensure on-time deliveries, even on complex projects. We maintain constant stock of both machines and accessories and consumables.

## **7** Guaranteed operational safety

All our machines comply with industrial safety standards, minimising risks for the operator and the environment.

## **8** Energy efficiency

We design equipment with low energy consumption without sacrificing power or productivity.

## **9** Active after-sales service and predictive maintenance

We support the customer beyond delivery with preventive maintenance programmes, training and upgrades, as well as the option of implementing an autonomous welding project with a robotic system.

## **10** Unbeatable cost-benefit ratio

We combine precision engineering, advanced technology and competitive pricing to maximise return on investment.



## ESA S820 CONTROL CHARACTERISTICS

The Nargesa MS20 Welder features a 7" colour touch screen control, highly intuitive and easy to use, with the latest 4.0 technology. **The process is simple and intuitive:** the operator selects the material, thickness, type of gas, number of wires, wire diameter, and the appropriate nozzle.

Based on this information, the control automatically loads the **optimal welding parameters**, previously validated at the factory, ensuring **consistent and repeatable results**.

In addition, the user can **modify and save programs** easily to adapt them to specific production needs.

These are some of the most relevant features of this control:

- > Storage capacity for up to 10,000 programs.
- > Programming in inches or millimetres.
- > Powerful welding, cleaning and cutting database.
- > Library of available materials, with the option to add new ones.
- > Welding and materials library.
- > Cleaning and materials library.
- > Cutting and materials library.
- > Dynamic temperature control for the protection lens.
- > Dynamic temperature control for the focus lens.
- > Dynamic temperature control for the torch motor.
- > Programming available in more than 20 languages.
- > Industry 4.0 technology.
- > On-screen alarm diagnostics.
- > Preventive maintenance alerts.
- > Possibility of remote connection by the manufacturer without being on-site.
- > 7" colour touch screen with 800x480 resolution.
- > 128 MB silicon disk.
- > 2 analogue inputs, 12-bit resolution.
- > 16 digital inputs (24 VDC).
- > 16 digital outputs (24 VDC, 0.7 A max.), protected against overloads and short circuits.
- > 1 RS232 serial port.
- > 1 CAN port with 9-pin SubD F connector.
- > 1 USB port.

# OUTSIDE DIMENSIONS

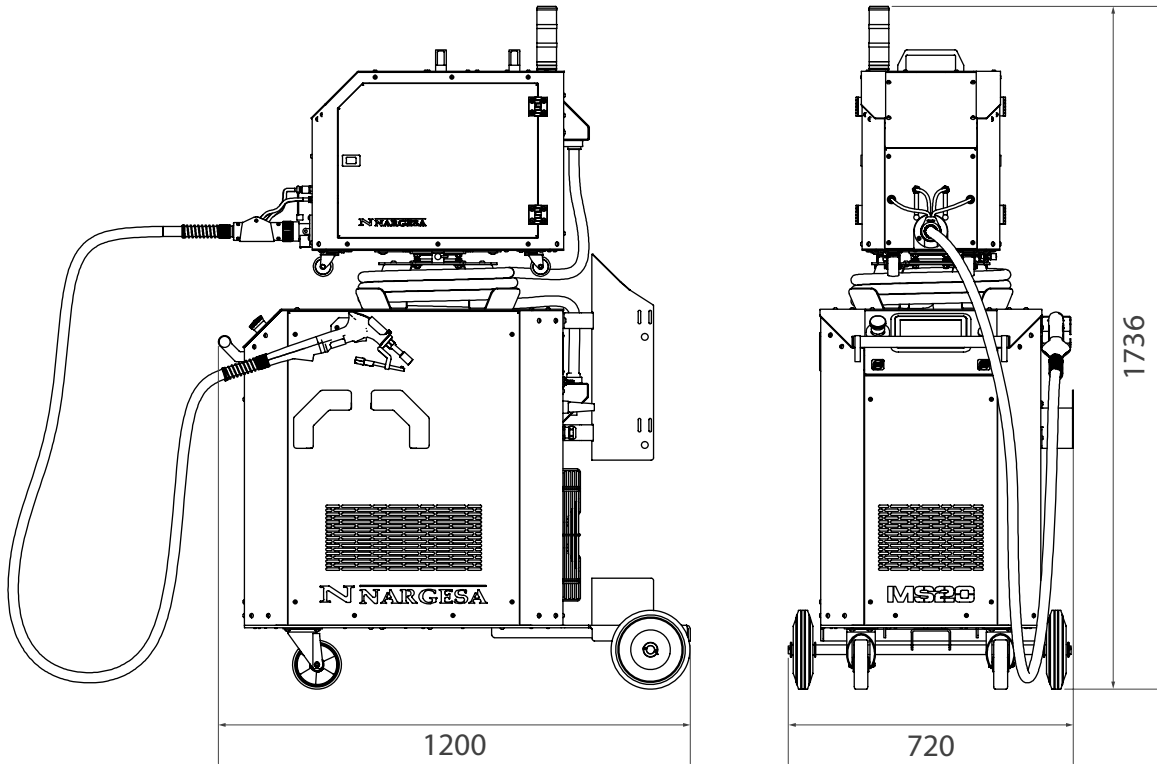

# PACKAGING CHARACTERISTICS

- Tariff Code: 85158090
- Wheels for proper transport both on the machine and on the feeder.
- The machine is shipped fully assembled.
- Packaging with NIMF15 wooden pallet and 3-layer cardboard box suitable for maritime transport.
- Optional: NIMF15 wooden packaging.

## MS20

Width	780 mm
Depth	1280 mm
Height	1950 mm
Volume	1,946 m <sup>3</sup>
Net weight	264 Kg
Gross weight	310 Kg.

# STANDARD ACCESSORIES SUPPLIED WITH THE MACHINE

## Complete equipment, no surprises

---

In the machines we manufacture, quality is not limited to the structure or the CNC control: it also extends to every additional component. That is why we deliver a **highly equipped solution from day one**, with a selection of **factory-included accessories** that go beyond what is standard in the market.

Each accessory has been carefully chosen to **enhance the operability, safety and efficiency of the equipment**, with no need for additional costs or later adaptations.

Below, we detail everything that is **included as standard** with your machine. A configuration designed so that you can start producing at the **highest level from the very first day**.

## Laser head holder

---



**REF: 130-19-01-00018**

Ergonomic support for the laser welding head. Steel structure with technical plastic padding to protect the torch when at rest. Textured black finish designed for the MS20.

- **Safety and organization:** prevents head drops and damage to lens/nozzles.
- **Full protection:** anti-scratch, non-slip padded blocks.
- **Quick access:** cradle-shaped geometry for one-hand placement and removal.
- **Magnetic mounting:** fixation by magnet on frame/table for easy positioning in the workspace.

## Laser Safety Glasses

---



**REF: 080-MSL-00021**

Laser welding safety glasses with a specific filter for 900–1100 nm wavelength range. Wraparound frame covers front and sides, lightweight and comfortable for extended use. Case included.

- **Eye protection** for the 900–1100 nm band (fiber laser).
- **High optical density (OD)** to minimize incidental exposure risk.
- **Wraparound design:** protects against direct/reflected radiation and fine particles.
- **Comfort:** curved temples and stable fit under visor or helmet.
- **Certified safety and marking:** compliant with Standard Technical Rules and the essential requirements according to Annex II of the PPE Regulation (EU) 2016/425, in accordance with EN 207:2017. Marking: 740–900 D LB6 + I LB7, 900–1100 D LB6 + IR LB7 LP S CE, indicating the protection levels against laser radiation in the specified spectral ranges.

## Triple Allen Key 2–2.5–3 mm

---



**REF: 080-MSL-00029**

Y-shaped triple Allen key with 2 / 2.5 / 3 mm tips. Ergonomic orange polymer body for a comfortable and secure grip.

## Phillips Precision Screwdriver

---



**REF: 080-MSL-00030**

Precision screwdriver with Phillips (PH) tip for fine electronic and light mechanical work. Blue/yellow dual-color handle with rotating cap for palm support and controlled turning. Magnetizable tip for easy screw placement.

## Double Open-End Wrench 17–21 mm

---



**REF: 120-19-01-00109**

Double open-end wrench with 17 mm and 21 mm jaws. Slim profile and flat body for reaching narrow areas (fittings, nozzle nuts, and connections). Black finish with high resistance to wear and corrosion.

## Double to Single Nozzle Adapter

---



**REF: 120-19-01-00091**

Nozzle adapter converting dual outlet to single for laser welding guns. Machined brass body with corrosion resistance.

Designed to simplify switching from dual to single feed.

## Protection Lens

---



**REF: 080-MSL-00332**

Protective lens for welding, cutting, and cleaning weld beads.

10 protective lenses are supplied with the MS20.

## Weld Seam Cleaning Graded Tube



**REF: 080-MSL-00430**  
Nozzle for cleaning weld seams







## Centering Tape



**REF: 080-MSL-00335**  
Tape for centering the laser beam











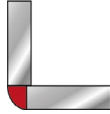

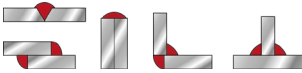
## Wire feed rollers

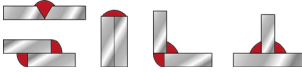
Wire feed rollers with double U-groove or V-groove, for different wire sizes and materials.  
4 rollers of each type are supplied.

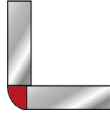
	Reference	Description	Wire Ø
	080-MSL-00326	Roller 0,8-1,0 U U-groove feed roller for aluminum wire.	0,8 and 1,0mm.
	080-MSL-00327	Roller 1.2-1.6 U U-groove feed roller for aluminum wire.	1,2 and 1,6mm.
	080-MSL-00328	Roller 1.6-2.0 U U-groove feed roller for aluminum wire.	1,6 and 2,0 mm.
	080-MSL-00329	Roller 0,8-1,0 V V-groove feed roller for steel wire.	0,8 and 1,0mm.
	080-MSL-00330	Roller 1,2-1,6 V V-groove feed roller for steel wire.	1,2 and 1,6 mm.
	080-MSL-00331	Roller 1,6-2,0 V V-groove feed roller for steel wire.	1,6 and 2,0 mm.

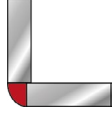
## Laser Welding Nozzles

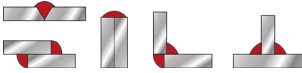
Laser welding nozzles with and without filler wire feed, for different welding applications. One nozzle of each type is supplied.

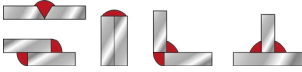
	Description	Wires	Type of welding	Wire Ø	Model
	Ref: 080-MSL-00413 Nozzle for autogenous welding, for outside corner welding.	-		-	C
	Ref: 080-MSL-00415 Nozzle for welding with filler wire up to 1.2 mm, for flat welding, inside corners and outside corners.	1		1.2 mm	AS-12
	Ref: 080-MSL-00416 Nozzle for welding with filler wire up to 1.6 mm, for flat welding, inside corners and outside corners.	1		1.6 mm	BS-16
	Ref: 080-MSL-00419 Nozzle for welding with filler wire up to 1.2 mm, for outside corner welding.	1		1.2 mm	CS-12
	Ref: 080-MSL-00431 Nozzle for welding with filler wire up to 1.6 mm, for outside corner welding.	1		1.6 mm	ES-16 FS-16
	Ref: 080-MSL-00425 Nozzle for welding with dual filler wire feed up to 1.2 mm, for flat welding, inside corners and outside corners.	2		1.2 mm	AS-12D
	Ref: 080-MSL-00427 Nozzle for welding with dual filler wire feed up to 2.0 mm, for flat welding, inside corners and outside corners.	2		2.0 mm	AS-20D

## Nozzle and tip for cutting









Nozzle and tip for laser cutting. One set is supplied, consisting of 1 nozzle and 1 tip.

	Description	Model
	Ref. 080-MSL-00428 Nozzle and tip set for sheet metal cutting.	CT-15

## Feed noozles

Wire feed guide noozles.

One nozzle of each type is supplied.

	Ref.	Description	Wires	Wire Ø
	080-MSL-00402	Double wire feed nozzle 1.0 mm Double wire feed guide nozzle, 1.0 mm.	2	1,0 mm.
	080-MSL-00403	Double wire feed nozzle 1.2 mm Double wire feed guide nozzle, 1.2 mm.	2	1,2 mm.
	080-MSL-00404	Double wire feed nozzle 1.6 mm Double wire feed guide nozzle, 1.6 mm.	2	1,6 mm.
	080-MSL-00405	Double wire feed nozzle 2.0 mm Double wire feed guide nozzle, 2.0 mm.	2	2,0 mm.
	080-MSL-00406	Single wire feed nozzle 0.8 mm Wire feed guide nozzle, 0.8 mm.	1	0,8 mm.
	080-MSL-00407	Single wire feed nozzle 1.0 mm Wire feed guide nozzle, 1.0 mm.	1	1,0 mm.
	080-MSL-00408	Single wire feed nozzle 1.2 mm Wire feed guide nozzle, 1.2 mm.	1	1,2 mm.
	080-MSL-00409	Single wire feed nozzle 1.6 mm Wire feed guide nozzle, 1.6 mm.	1	1,6 mm.
	080-MSL-00410	Single wire feed nozzle 2.0 mm Wire feed guide nozzle, 2.0 mm.	1	2,0 mm.

# OPTIONAL ACCESSORIES AND SUPPLIES

## Electronic Laser Protection Mask



**REF: 080-MSL-00023**

Auto-darkening electronic helmet with adjustable sensitivity and solar-powered photosensor for laser work. Wraparound polymer shell with adjustable harness and specific front laser filter. Side control for shade adjustment. Designed to protect the operator's eyes and face during laser welding and marking operations, according to filter configuration.



- **Full eye and face protection** against laser radiation (per installed filter), sparks, and light projections.
- **Adjustable auto-darkening:** automatic shade change upon emission detection (response time and darkness level configurable).
- **Comfort for long use:** lightweight, balanced helmet with adjustable headgear (diameter, height, and depth) for superior comfort.
- **High visibility in standby:** light mode for positioning and part preparation with precision.
- **Certified safety and marking:** compliant with the Standard technical rules and the essential requirements of Annex II of PPE Regulation (EU) 2016/425 (EN ISO 16321-1:2022, EN ISO 16321-2:2021, ISO 16321-1:2021/Amd.1:2024, EN 207:2017). Marking: eye protection 16321 LP W4 1-M, 950-100 D LB7 IR LB8 LP CE; face and head protection 16321 LP W4 1-M, 900-1100 D LB5 IR LB8 LP CE; automatic welding filter 11961-PZA-24.

## Laser Protection Mask



**REF: 080-MSL-00022**











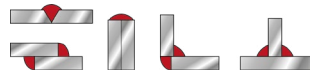

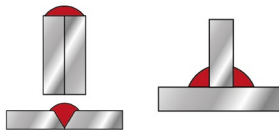

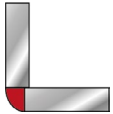

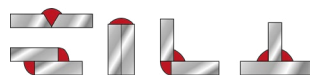

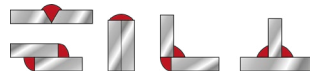

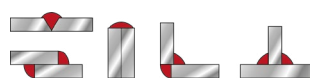

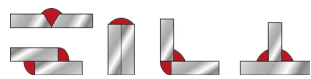
Passive laser welding mask with specific green laser visor. Lightweight wraparound helmet with adjustable headgear and side adjustment. Designed to protect the operator's eyes and face during manual laser welding and auxiliary operations against UV exposure.

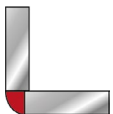

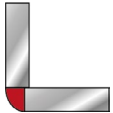

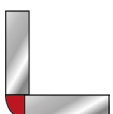

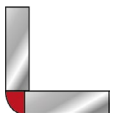

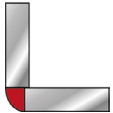

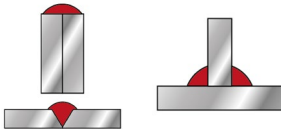

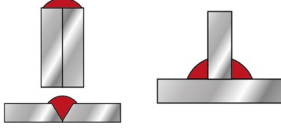
- **Eye and face protection** against laser radiation and light projections during welding.
- **Simplicity and reliability:** no electronics or batteries; minimal maintenance.
- **Comfort:** adjustable headgear for diameter, height, and depth.
- **Wide field of view** with large passive visor.
- **Certified safety and marking:** compliant with the essential requirements of Annex II of PPE Regulation (EU) 2016/425, in accordance with EN ISO 16321-2:2021 and EN 207:2017. Marking: eye protection 16321 LP W4 1-M, 950-100 D LB7 IR LB8 LP CE; face and head protection 16321 LP W4 1-M, 900-1100 D LB5 IR LB8 LP CE.

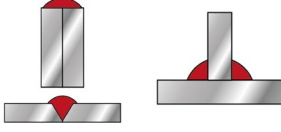
## Laser Welding Nozzles

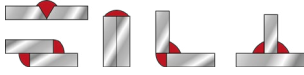

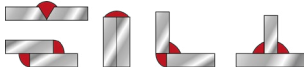
Laser welding nozzles with and without filler wire feed, for different welding applications.

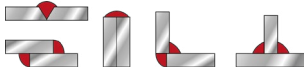
	Description	Wires	Type of welding	Wire Ø	Model
	Ref: 080-MSL-00411 Nozzle for autogenous welding, for flat welds, inside corners and outside corners.	-		-	A
	Ref: 080-MSL-00412 Nozzle for autogenous welding, for flat welds or inside corners.	-		-	B
	Ref: 080-MSL-00413 Nozzle for autogenous welding, for outside corner welding.	-		-	C
	Ref: 080-MSL-00414 Nozzle for welding with filler wire up to 1.0 mm, for flat welding, inside corners and outside corners.	1		1.0 mm	AS-10
	Ref: 080-MSL-00415 Nozzle for welding with filler wire up to 1.2 mm, for flat welding, inside corners and outside corners.	1		1.2 mm	AS-12
	Ref: 080-MSL-00416 Nozzle for welding with filler wire up to 1.6 mm, for flat welding, inside corners and outside corners.	1		1.6 mm	BS-16
	Ref: 080-MSL-00417 Nozzle for welding with filler wire up to 2.0 mm, for flat welding, inside corners and outside corners.	1		2.0 mm	BS-20
	Ref: 080-MSL-00418 Nozzle for welding with filler wire up to 1.0 mm, for outside corner welding.	1		1.0 mm	CS-10
	Ref: 080-MSL-00419 Nozzle for welding with filler wire up to 1.2 mm, for outside corner welding.	1		1.2 mm	CS-12
	Ref: 080-MSL-00420 Nozzle for welding with filler wire up to 1.6 mm, for outside corner welding.	1		1.6 mm	CS-16
	Ref: 080-MSL-00421 Nozzle for welding with filler wire up to 1.2 mm, for outside corner welding.	1		1.2 mm	ES-12
	Ref: 080-MSL-00431 Nozzle for welding with filler wire up to 1.6 mm, for outside corner welding.	1		1.6 mm	ES-16 FS-16







	Description	Wires	Type of welding	Wire Ø	Model
	Ref: 080-MSL-00422 Nozzle for welding with filler wire up to 1.0 mm, for flat welding and inside corners.	1		1.0 mm	DS-10
	Ref: 080-MSL-00423 Nozzle for welding with filler wire up to 1.2 mm, for flat welding and inside corners.	1		1.2 mm	DS-12
	Ref: 080-MSL-00424 Nozzle for welding with filler wire up to 1.6 mm, for flat welding and inside corners.	1		1.6 mm	DS-16
	Ref: 080-MSL-00425 Nozzle for welding with dual filler wire feed up to 1.2 mm, for flat welding, inside corners and outside corners.	2		1.2 mm	AS-12D
	Ref: 080-MSL-00426 Nozzle for welding with dual filler wire feed up to 1.6 mm, for flat welding, inside corners and outside corners.	2		1.6 mm	AS-16D
	Ref: 080-MSL-00427 Nozzle for welding with dual filler wire feed up to 2.0 mm, for flat welding, inside corners and outside corners.	2		2.0 mm	AS-20D

## Nozzle and tip for cutting





Nozzle and tip for laser cutting. One set is supplied, consisting of 1 nozzle and 1 tip.

	Description	Model
	Ref: 080-MSL-00428 Nozzle and tip set for sheet metal cutting.	CT-15
	Ref: 080-MSL-00429 1.5 mm tip for the cutting nozzle.	CT-15

## Steel, Teflon and Graphite Liners







Description	
	Ref. 080-MSL-00301 Steel Liner Blue 0.6-0.8, 5m Welding liner for 0.6–0.8 mm steel wire, 5 m
	Ref. 080-MSL-00302 Steel Liner Red 1.0-1.2, 5m Welding liner for 1.0–1.2 mm steel wire, 5 m
	Ref. 080-MSL-00304 Teflon Liner Blue 0.6-0.8, 5m Welding liner for 0.6–0.8 mm aluminium wire, 5 m
	Ref. 080-MSL-00305 Teflon Liner Red 1.0-1.2, 5m Welding liner for 1.0–1.2 mm aluminium wire, 5 m
	Ref. 080-MSL-00306 Teflon Liner Yellow 1.4-1.6, 5m Welding liner for 1.4–1.6 mm aluminium wire, 5 m
	Ref. 080-MSL-00307 Graphite Liner 1.0-2.0, 5m Welding liner for 1.0–2.0 mm aluminium wire, 5 m
	Ref. 080-MSL-00308 Steel Liner 1.2-2.0, 5m Welding liner for 1.2–2.0 mm steel wire, 5 m

## Lenses

Description	
	Ref. 080-MSL-00323 Reflective Lens Reflective lens for welding, cutting and weld bead cleaning.
	Ref. 080-MSL-00321 Focusing Lens D20 × F150 × T3 Focusing lens D20 F150 for welding, cutting and weld bead cleaning.
	Ref. 080-MSL-00320 Collimating Lens D16 × F60 × T3 Collimating lens D16 for welding, cutting and weld bead cleaning.
	Ref. 080-MSL-00332 Protective Lens Protective lens for welding, cutting and weld bead cleaning.

## Feed rollers

Feed rollers with double "U" or "V" groove for different wire sizes and materials.

	Ref.	Description	Wires Ø
	080-MSL-00326	Roller 0.8-1.0 U U-groove feed roller for aluminum wire.	0,8 y 1,0mm.
	080-MSL-00327	Roller 1.2-1.6 U U-groove feed roller for aluminum wire.	1,2 y 1,6mm.
	080-MSL-00328	Roller 1.6-2.0 U U-groove feed roller for aluminum wire.	1,6 y 2,0 mm.
	080-MSL-00329	Roller 0.8-1.0 V V-groove feed roller for steel wire.	0,8 y 1,0mm.
	080-MSL-00330	Roller 1.2-1.6 V V-groove feed roller for steel wire.	1,2 y 1,6 mm.
	080-MSL-00331	Roller 1.6-2.0 V V-groove feed roller for steel wire.	1,6 y 2,0 mm.

## Graded Tube











**REF: 080-MSL-00334**

Graduated focusing tube for nozzles.

## Feed noozles

Wire feed guide noozles.

	Ref.	Description	Wires	Wire Ø
	080-MSL-00402	Double wire feed nozzle 1.0 mm Double wire feed guide nozzle, 1.0 mm.	2	1,0 mm.
	080-MSL-00403	Double wire feed nozzle 1.2 mm Double wire feed guide nozzle, 1.2 mm.	2	1,2 mm.
	080-MSL-00404	Double wire feed nozzle 1.6 mm Double wire feed guide nozzle, 1.6 mm.	2	1,6 mm.
	080-MSL-00405	Double wire feed nozzle 2.0 mm Double wire feed guide nozzle, 2.0 mm.	2	2,0 mm.
	080-MSL-00406	Single wire feed nozzle 0.8 mm Wire feed guide nozzle, 0.8 mm.	1	0,8 mm.
	080-MSL-00407	Single wire feed nozzle 1.0 mm Wire feed guide nozzle, 1.0 mm.	1	1,0 mm.
	080-MSL-00408	Single wire feed nozzle 1.2 mm Wire feed guide nozzle, 1.2 mm.	1	1,2 mm.
	080-MSL-00409	Single wire feed nozzle 1.6 mm Wire feed guide nozzle, 1.6 mm.	1	1,6 mm.
	080-MSL-00410	Single wire feed nozzle 2.0 mm Wire feed guide nozzle, 2.0 mm.	1	2,0 mm.

# OUR RANGE OF MACHINERY



IRON WORKERS



NON-MANDREL PIPE BENDER



HORIZONTAL PRESS BRAKES



SECTION BENDING MACHINES



CNC SECTION BENDING MACHINES



LASER WELDING EQUIPMENT



TWISTING/SCROLL BENDING MACHINES



HYDRAULIC PRESS BRAKES



HYDRAULIC SHEAR MACHINES



GAS FORGES



IRON EMBOSSING MACHINES



END WROUGHT IRON MACHINES



BROACHING MACHINES



POWER HAMMERS



BLACKSMITH FORGING PRESS

Partner companies



Airpharm

## SHIPMENT EVERYWHERE

Nargeses will arrange transport up to final destination, whenever the customer asks for so. There is also the possibility for the customer to arrange the shipment himself with his own agency.

## TECHNICAL ASSISTANCE

All our customers have access to technical support quickly and efficiently. 90% of incidences are solved out on the phone, mail, Skype or videoconferencing in less than 24 hours. In case of needing presential technical assistance, we may as well send a technician to the customer's facilities.

Follow us on

---

### **PRADA NARGESA, S.L.**

Ctra. De Garrigàs a Sant Miquel s/n  
17476 Palau de Santa Eulalia (Girona) Spain  
Tel. +34 972 568 085

[www.nargeses.com](http://www.nargeses.com)

[nargeses@nargeses.com](mailto:nargeses@nargeses.com)



---

This information might undergo changes