

EMBOSSING MACHINE

NOA60

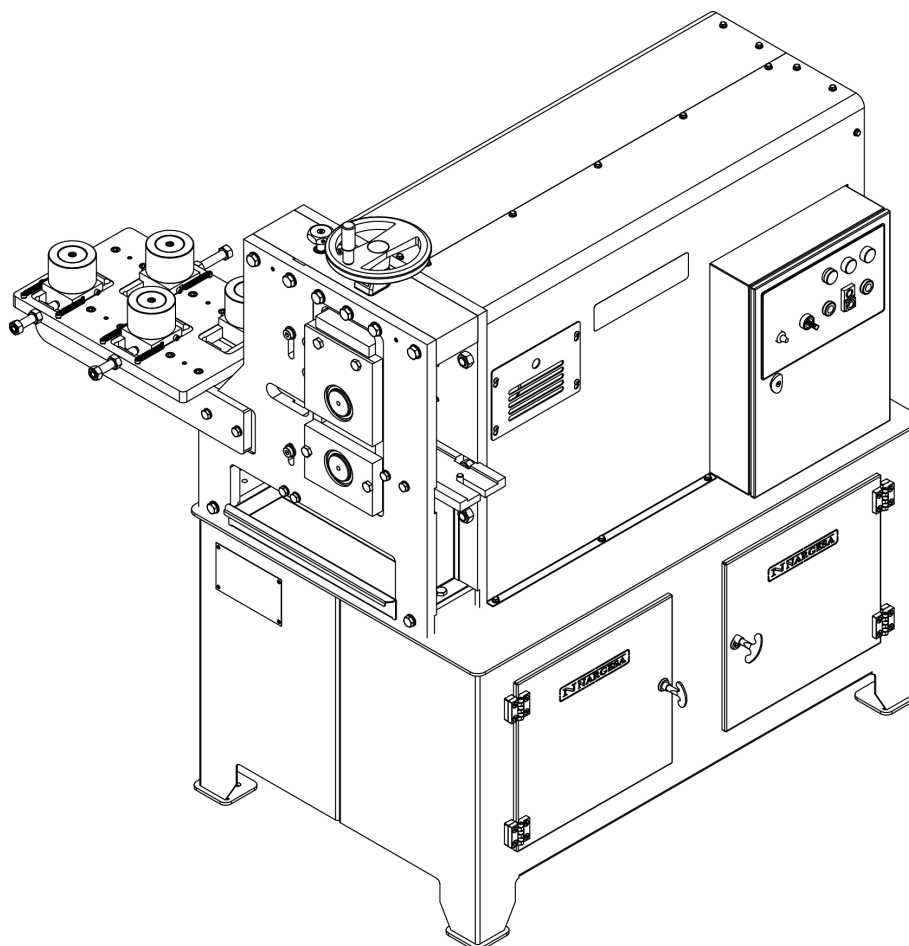

INSTRUCTIONS BOOK

PRADA NARGESA, S.L

Ctra. de Garrigàs a Sant Miquel s/n · 17476 Palau de Santa Eulàlia (Girona) SPAIN
Tel. +34 972568085 · nargesa@nargesa.com · www.nargesa.com

Thank you for choosing our machines



www.narges.com

INDEX

1. CHARACTERISTICS OF THE MACHINE	3
1.1. General dimensions	3
1.2. Description of the machine	3
1.3. Identifying parts of the machine	4
1.4. General specifications	5
1.5. Identifying the safeguards	6
2. TRANSPORTATION AND STORAGE	7
2.1. Transport	7
2.2. Storage conditions	7
3. MAINTENANCE AND CLEANING	8
3.1. General maintenance	8
3.1.1. Oil level	8
3.1.2. Lubricating the Transmission joint	9
3.2. Cleaning	9
4. INSTALLATION	10
4.1. Locating the machine	10
4.2. Work area	10
4.3. Admissible aouter conditions	11
4.4. Electrical connection	11
5. OPERATING MANUAL	12
5.1. Description of the Control Panel	12
5.2. Start up	12
5.3. Operation modes	13
5.3.1. Manual operation mode	13
5.3.2. Continuous/Automatic operations mode	13
5.4. Changing rollers and adjusting	13
5.4.1. Changing the rollers	14
5.4.2. Adjusting the machine	15
6. WARNINGS	17
7. TOOLING	18

ANNEXES

Technical annexe

Technical features of accessories

1. CHARACTERISTICS OF THE MACHINE

1.1. General dimensions

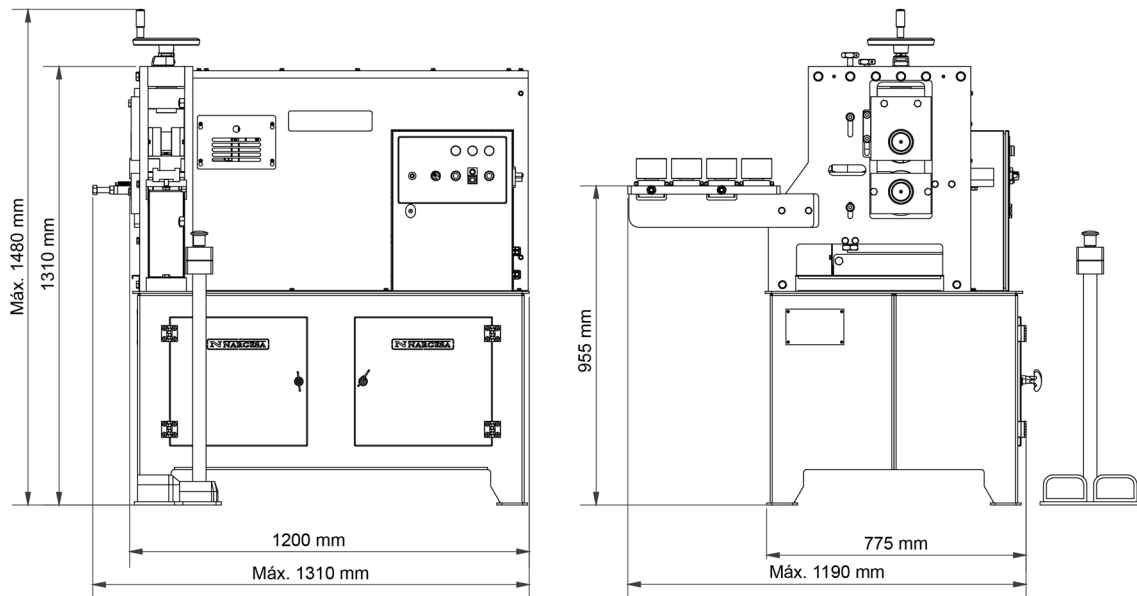

1.2. Description of the machine

The NARGESA NOA60 machine is designed to cold emboss shapes and designs on plates, tubes, square sections. The shape and design engraved will depend on the rollers used.

NOTE:

Any other use of this machine apart from its specifications what it was designed for could damage it and harm the people using it, in which case the manufacturer will accept no responsibility.

1.3. Identifying parts of the machine

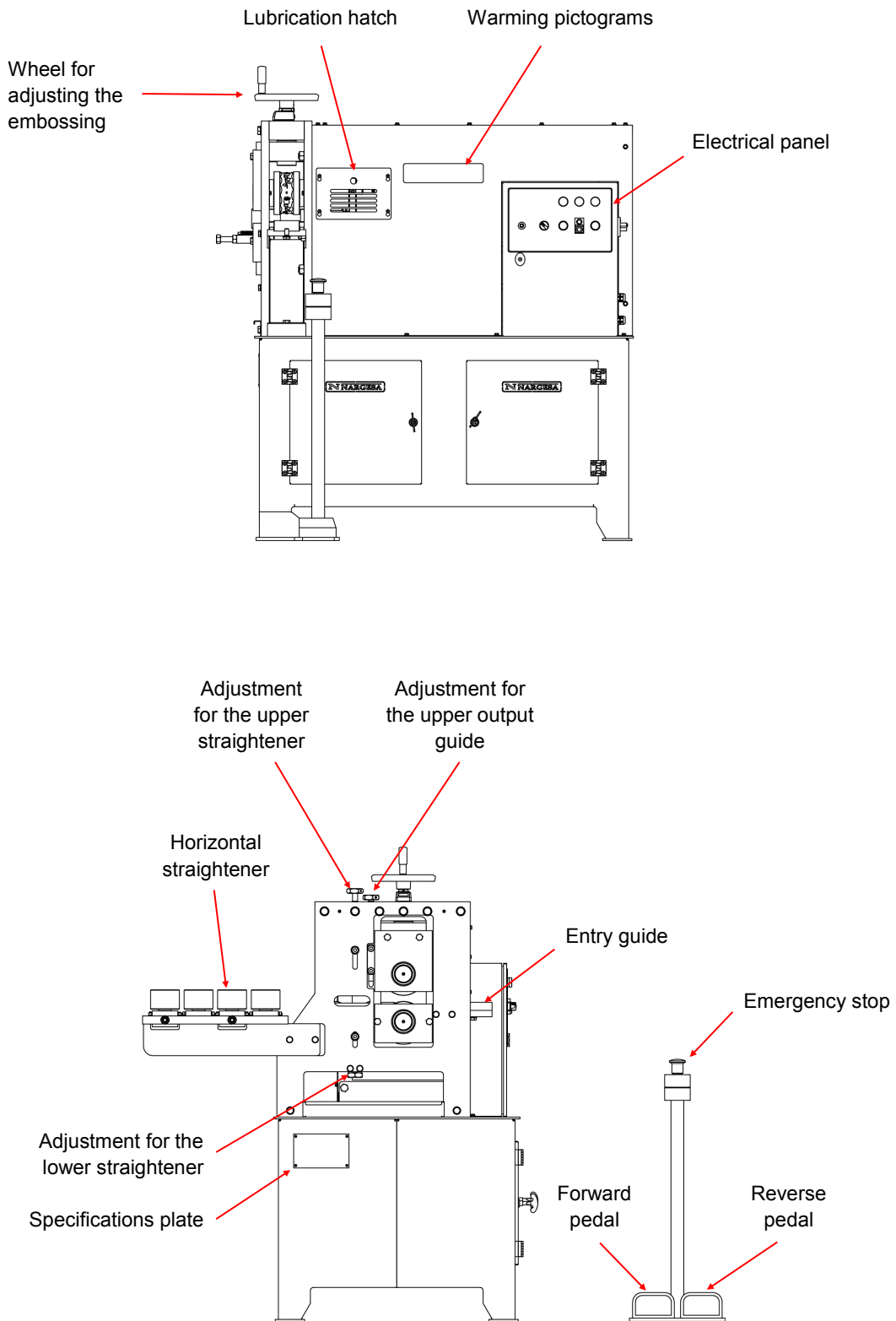

		www.nargesa.com			
PRADA NARGESA, S.L. - CTRA. DE GARRIGAS A SANT MIQUEL S/N 17476 PALAU DE STA. EULALIA (GIRONA) SPAIN - TEL.(+34) 972568085					
TRADEMARK NARGESA		MODEL NOA60			
YEAR OF MANUFACTURE		SERIAL N°			
DIMENSIONS		1190X1310X1480		mm. WEIGHT 690 Kg.	
POWER 5.5 Kw.		INTENSITY 21/12		A. Hz 50/60 rpm 1400 VOLTAGE 230/400V	
POWER		Kw. INTENSITY		A. Hz 50/60 rpm VOLTAGE 230/400V	

1.4. General specifications

- Electric motor 5.5 KW (7.5 HP) at 1400 r.p.m.
- Voltage 230/400 V three-phase
- Power consumption 21/12 A
- Working speed: variable, 20 rpm. at 50 Hz nominal
- Weight 690 Kg.
- Maximum capacity

Square tube	60 mm or 2" 1/2 inches
Solid square bar	20 mm or 3/4 inches
Plate	60x8 mm or 2"x3/8 inches

1.5. Identifying the safeguards

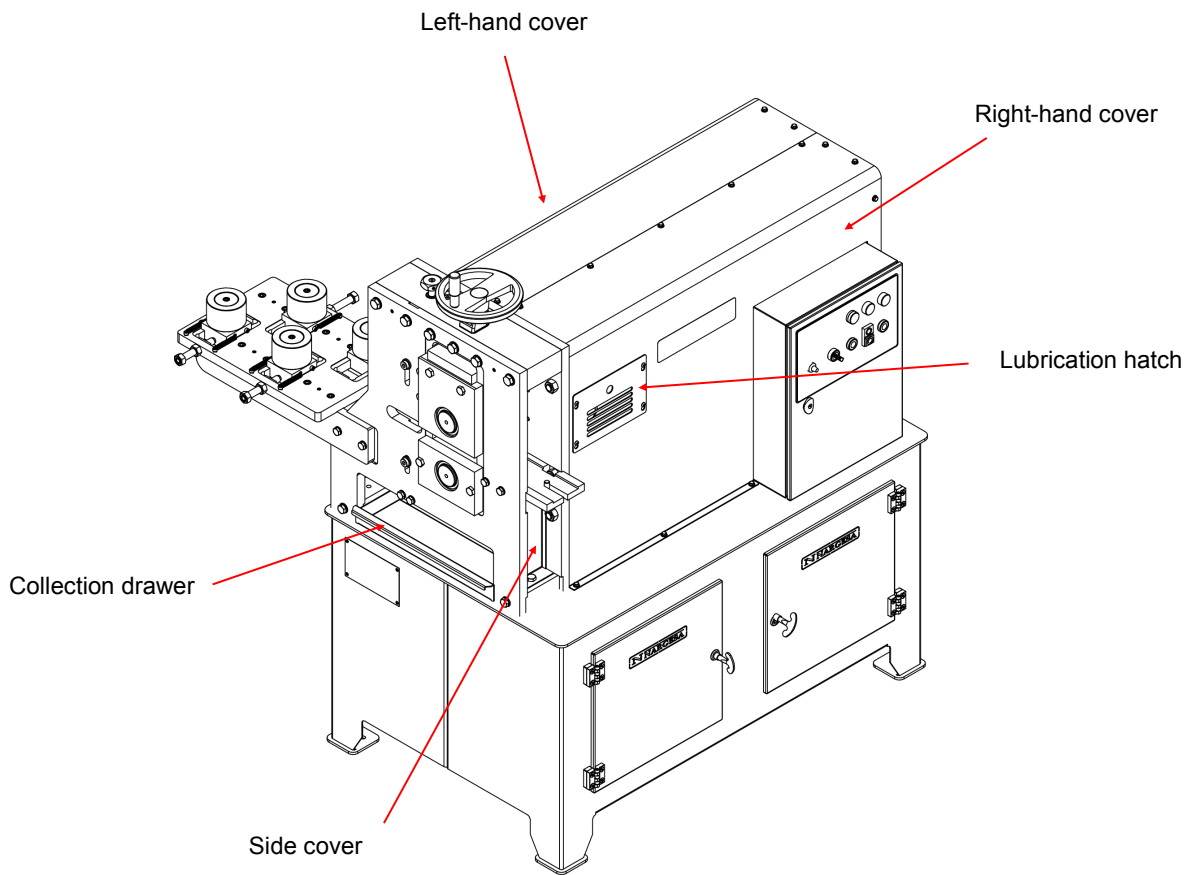

It is TOTALLY FORBIDDEN to operate the machine without its safeguards. These should only be removed in case of a breakdown or maintenance and always with the machine stationary.

2. TRANSPORTATION AND STORAGE

2.1. Transportation

Transportation of the machine is made by a forklift or by shovel, by using the clamping point of the lower base machine (designed for this purpose).

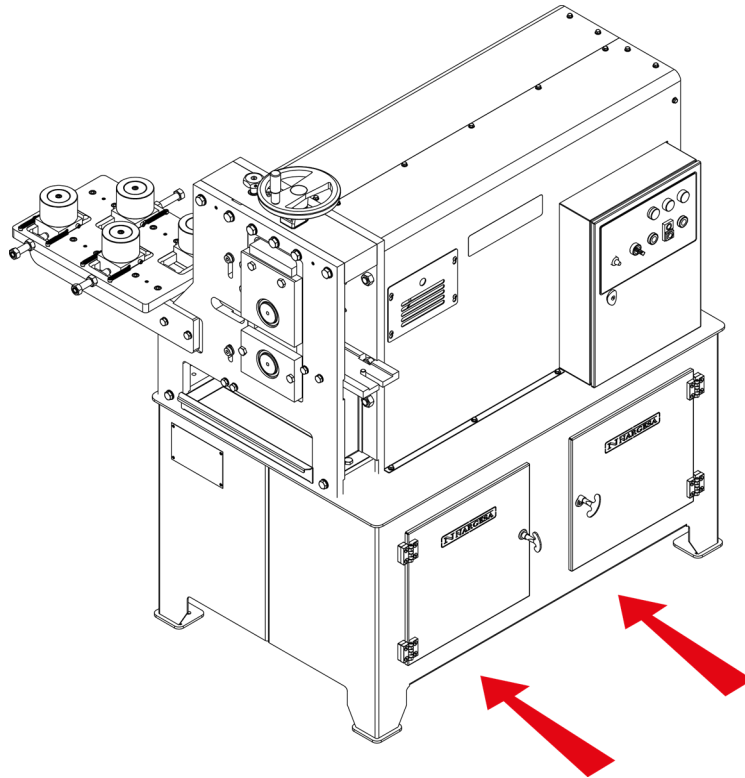

Risk of overturning the machine must be kept in mind.

2.2. Storage conditions

- * Relative humidity between 30% and 95% non-condensing.
- * Temperature 15 ° C and 55 ° C.
- * Do not stack anything on the machine.
- * Do not disassemble the machine for storage.

3. MAINTENANCE AND CLEANING

3.1. General maintenance

The NARGESA NOA60 engraving machine has been designed to be practically maintenance-free. Nevertheless, it is necessary to check the oil level of the gearbox and lubricate the transmission joint.

3.1.1. Oil level

To check the oil level of the gearbox there is a side sight glass, to access the sight glass, remove the side cover and make sure that the oil level is in the centre of the sight glass.

If this is not the case, look for any possible oil leaks, which must be repaired. In case of any doubt, our Technical Service can advise you at any time. If there are no leaks, top up the gearbox with SAE 80-140 oil through the filling cap until the level is in the middle of the sight glass.

This operation should be repeated every three months in case of continuous use of the machine.

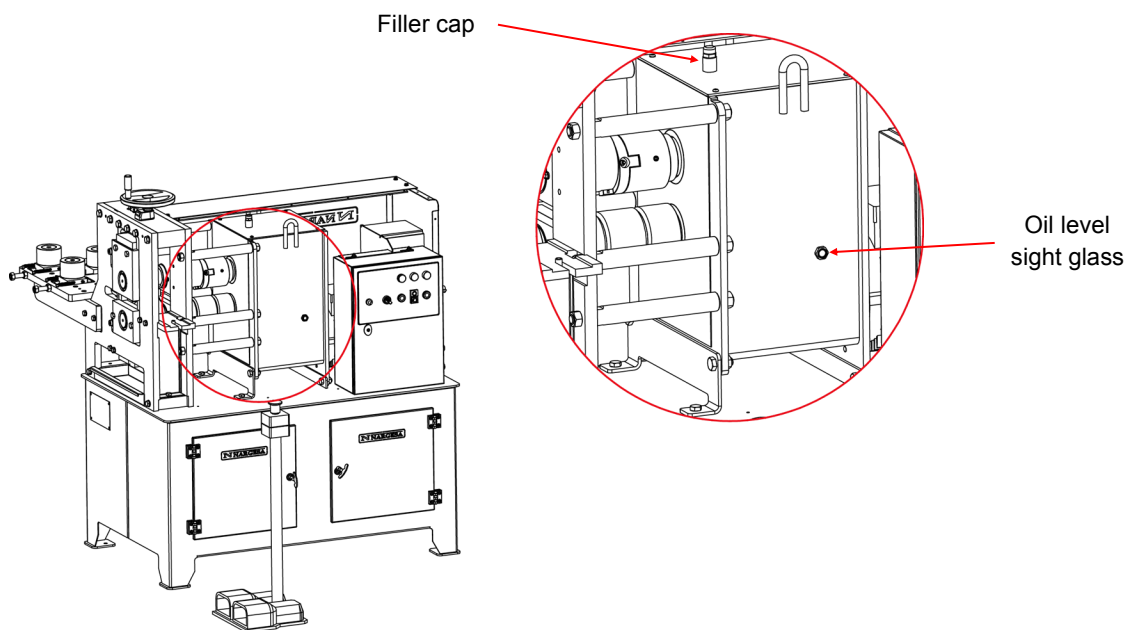

3.1.2. Lubricating the Transmission joint

The Transmission joint transmits the movement to the upper roller, which can move up or down.

This component should be lubricated approximately every 40 hours of operation.

To lubricate the transmission joint, remove the lubrication hatch and rotate the machine until the greaser is aligned with the opening and lubricate the joint with a lubrication pump.

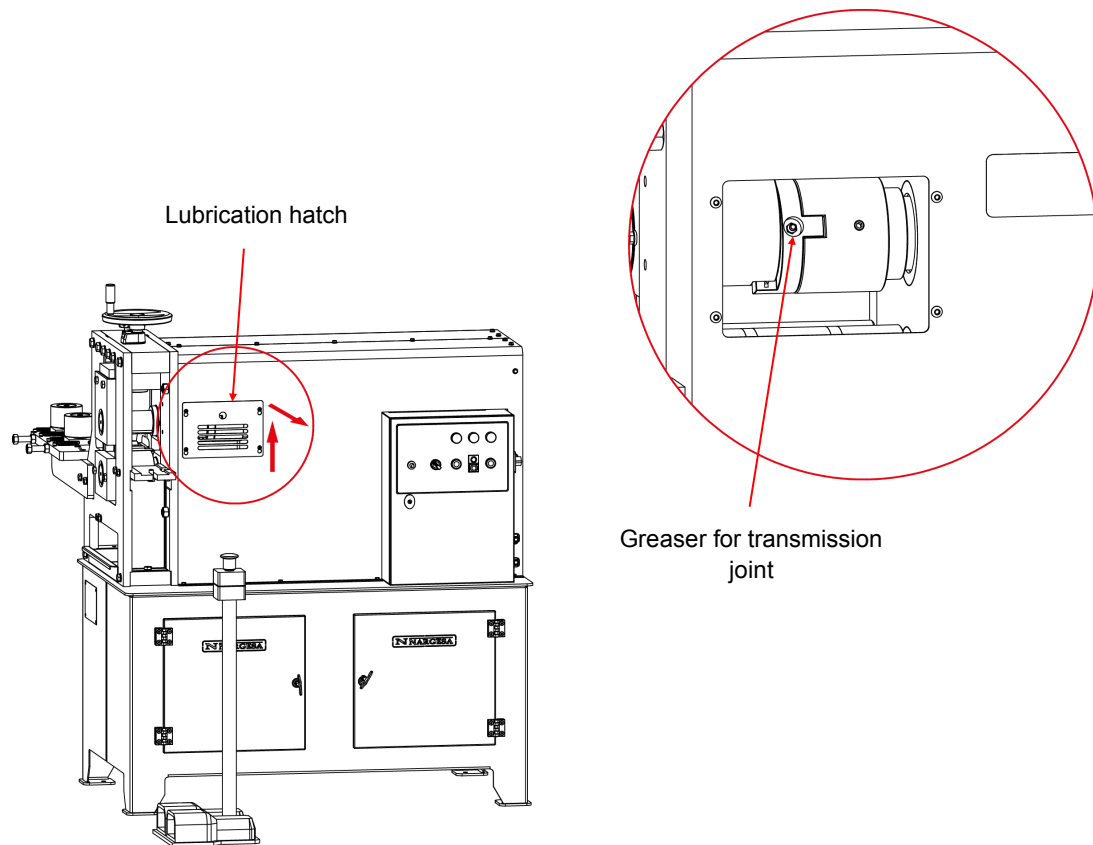

3.2. Cleaning

The NARGESA NOA60 engraving machine is designed to emboss material, this operation will produce scale. The machine has a tray to collect this below the rollers and the vertical straightener.

This should be removed and cleaned out regularly.

4. INSTALLATION

4.1. Locating the machine

The NARGESA NOA60 machine should be located on a smooth level surface. It can be anchored to the floor using the holes provided for this purpose in the base.

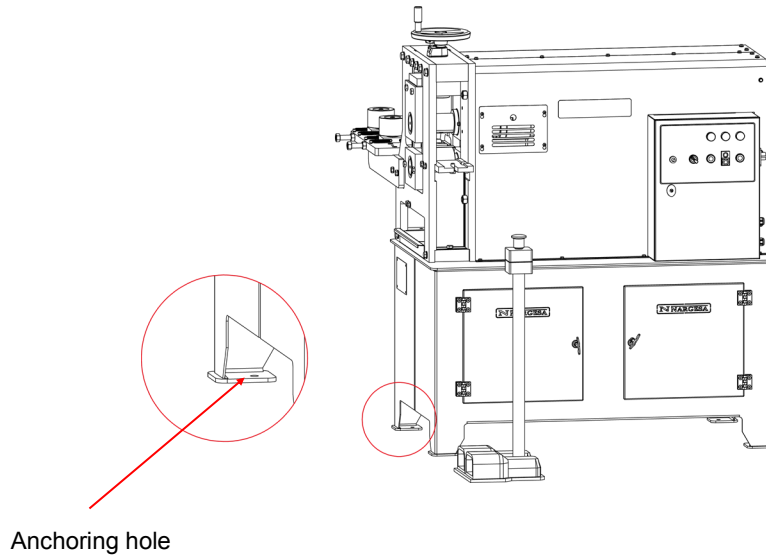

4.2. Work area

To use the NARGESA NOA60 machine, it is necessary to provide for enough space to load the material and for it to exit the machine.

The working position is at the front and from the side as indicated in the illustration.

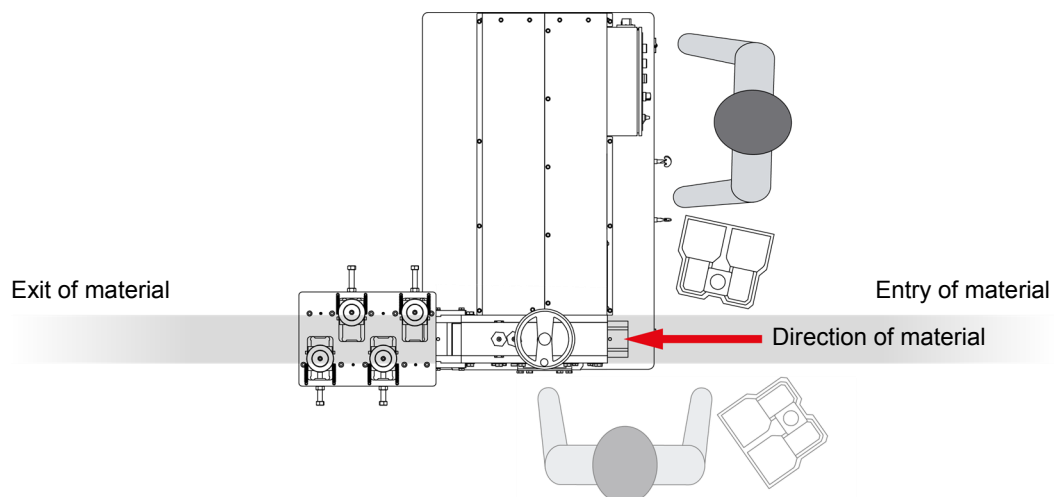

4.3. Admissible outer conditions

The working conditions of the machine NF70 NARGESA ranges between +5 ° C and +50 ° C and the maximum continuous temperature +45 ° C (24 hours)

The condition of humidity ranges between 30% and 90% non-condensing.

4.4. Electrical connection

The NARGESA NOA60 embossing machine is designed to be connected to a 230 or 400V three-phase 50/60Hz mains power supply.

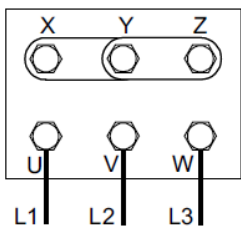

Star figure
(Pre-installed)
For 400V

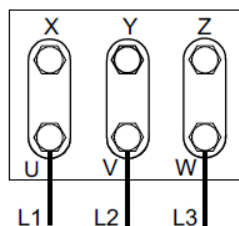

Triangle figure
For 230V

On using the machine, take into account that the direction of rotation of the rollers is as indicated in the illustration when the forward pedal is depressed.

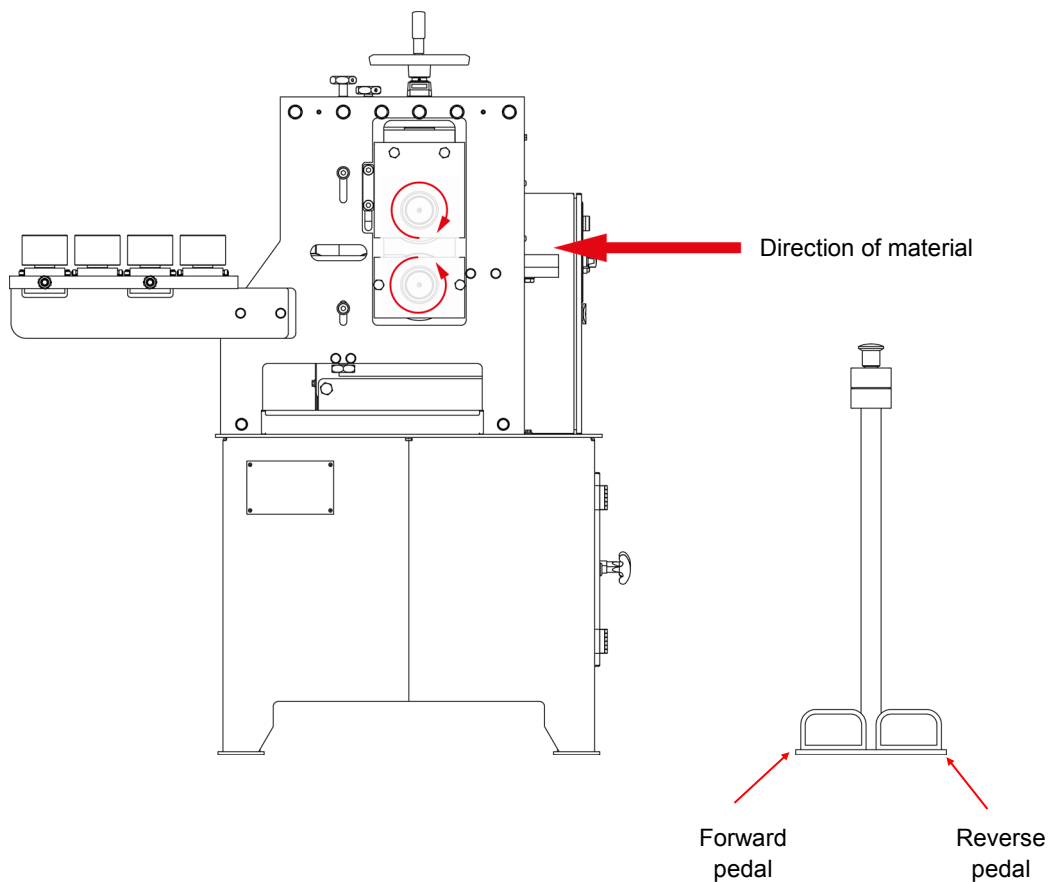

5. OPERATING MANUAL

5.1. Description of the Control Panel

The electric panel is on the front of the machine, incorporating the control panel described below.

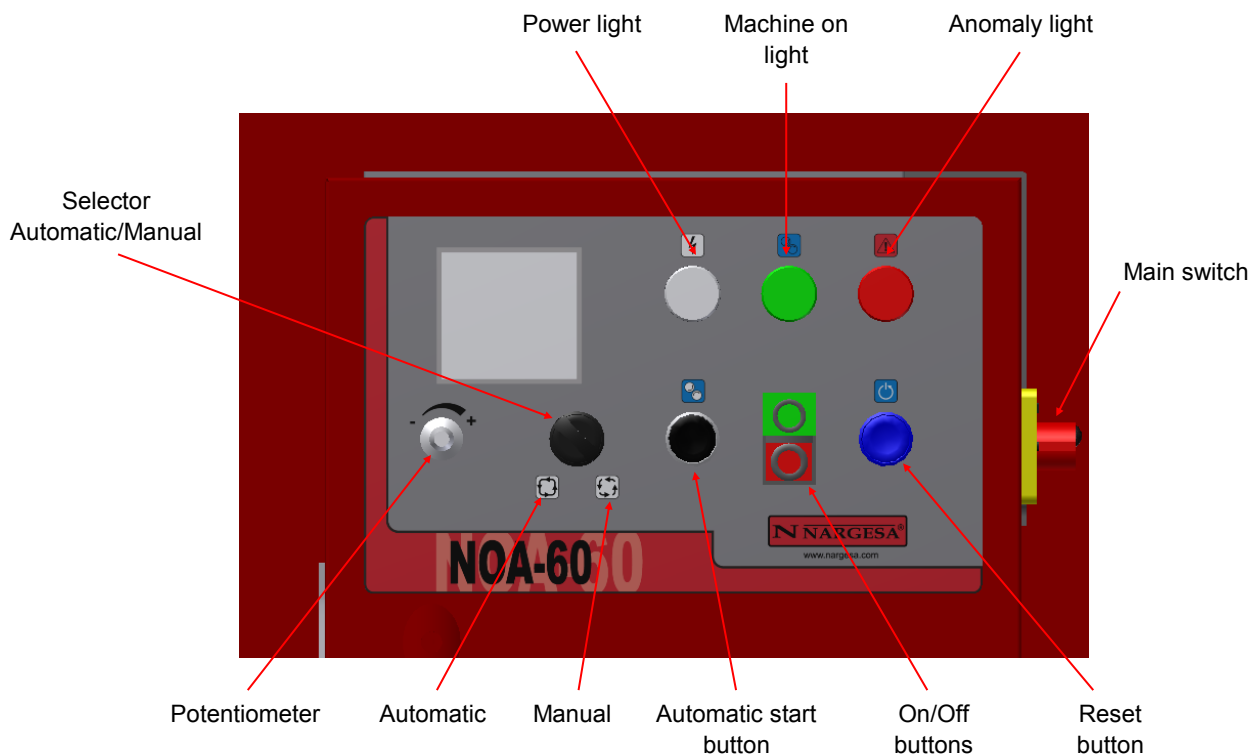

5.2. Start up

To begin working with the Nargesa NOA60 embossing machine, proceed as follows:

- Connect the machine to the electrical power supply.
- Turn Main switch to position 1. The white and red pilot lights will come on.
- Press the reset button (Blue button) and the red pilot light should go off, if this is not the case, check the emergency stop of the pedal. If it is activated, check that there is no problem in the roller area and unlock it. Press the blue reset button again, the pilot light should go off.
- Press the On button and when the green light comes on, the machine is ready for use.

5.3. Operation modes

The Nargesa NOA60 embossing machine has 2 different operation modes, which are:

Manual: Mode in which we can adjust the machine for production.

Continuous/Automatic: For working in continuous mode.

5.3.1. Manual operation mode

This mode of operation allows total control of the Nargesa NOA60 embossing machine at a reduced and fixed rotation speed, to adjust the machine.

To select Manual Operation, start up the machine as indicated in section 5.2 and rotate the selector to manual operation mode,  from that moment and with the aid of the pedals, you can control the direction of rotation of the machine forwards or backwards, depending on the pedal pressed, when you stop pressing the pedal, the machine will stop. In this mode of operation, it is possible to adjust the machine.

5.3.2. Continuous/Automatic operation mode

Once the Nargesa NOA60 embossing machine is adjusted, this mode is used to begin mass production.

To select this mode, turn the selector to the

Continuous/Automatic position  to start the machine:

- Press the Start Continuous/Automatic button on the control panel and the machine will begin to operate non-stop. To stop you will have to press the Stop Button.

In this mode of operation, the potentiometer on the Control Panel will enable you to adjust the speed of the machine.

5.4. Changing Rollers and Adjusting

The Nargesa NOA60 embossing machine, as commented above, embosses designs from the rollers onto the material. This chapter will explain how to change the rollers and how to adjust them for optimum results.

Take into account the the marking of the different materials needs different rollers, i.e., if you are marking a tubular section you will need two identical rollers to make the same markings on the faces, if it is a handrail, you will need a smooth roller for the lower face and an embossed one for the upper. In both types it will be necessary to have entry guides for the material adequate for each dimension.

5.4.1. Changing the rollers

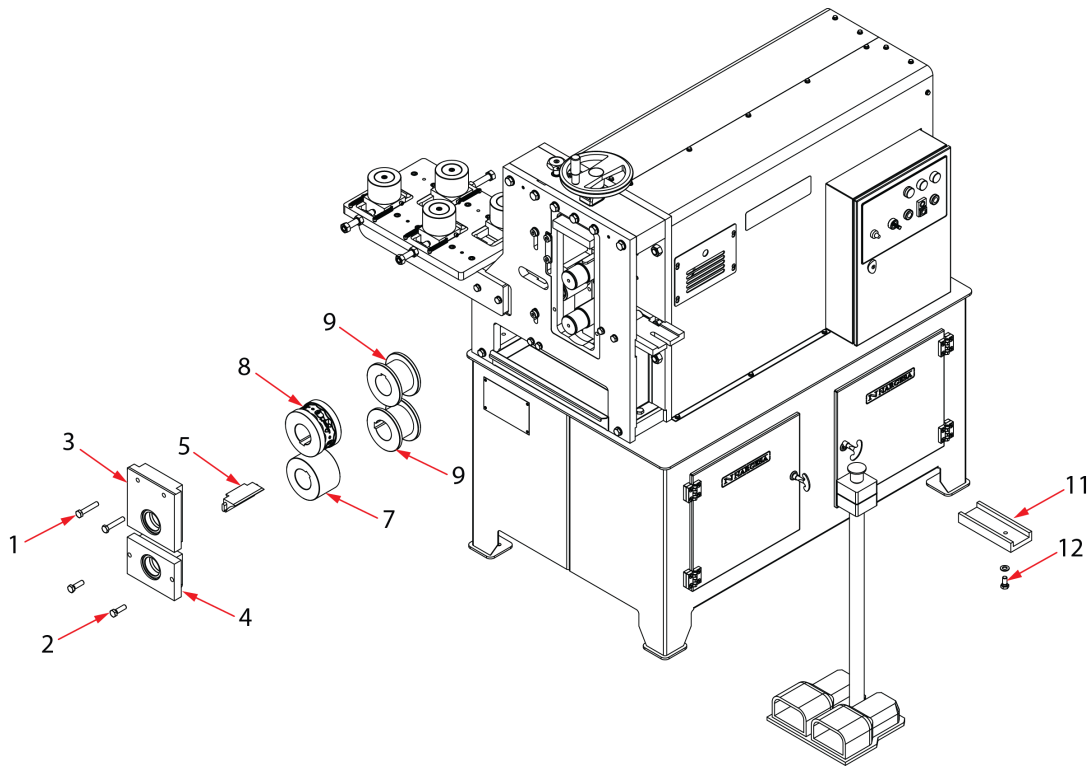

To change the rollers, raise the upper shaft using the Adjustment Wheel. Remove bolts 1 and 2 to release components 3 and 4, take out the lower guide 5. If you wish to emboss handrails, fit smooth roller 7 onto the lower shaft and the roller with the desired design 8 onto the upper shaft, fit the lower guide 5 into its housing, fit components 3 and 4 together with bolts 1 and 2 to secure them. Then fit the admission guide 11, which will be secured with bolt 12 to the machine. The NOA60 is now ready to begin adjustment, which will be explained in the following chapter.

If you wish to mark a tube, change roller 7 and 8 for rollers 9 **DO NOT INSTALL** the lower guide 5, as it is not necessary to mark tubes, fit components 3 and 4 with bolts 1 and 2 as well as the corresponding admission guide 11.

5.4.2. Adjusting the machine

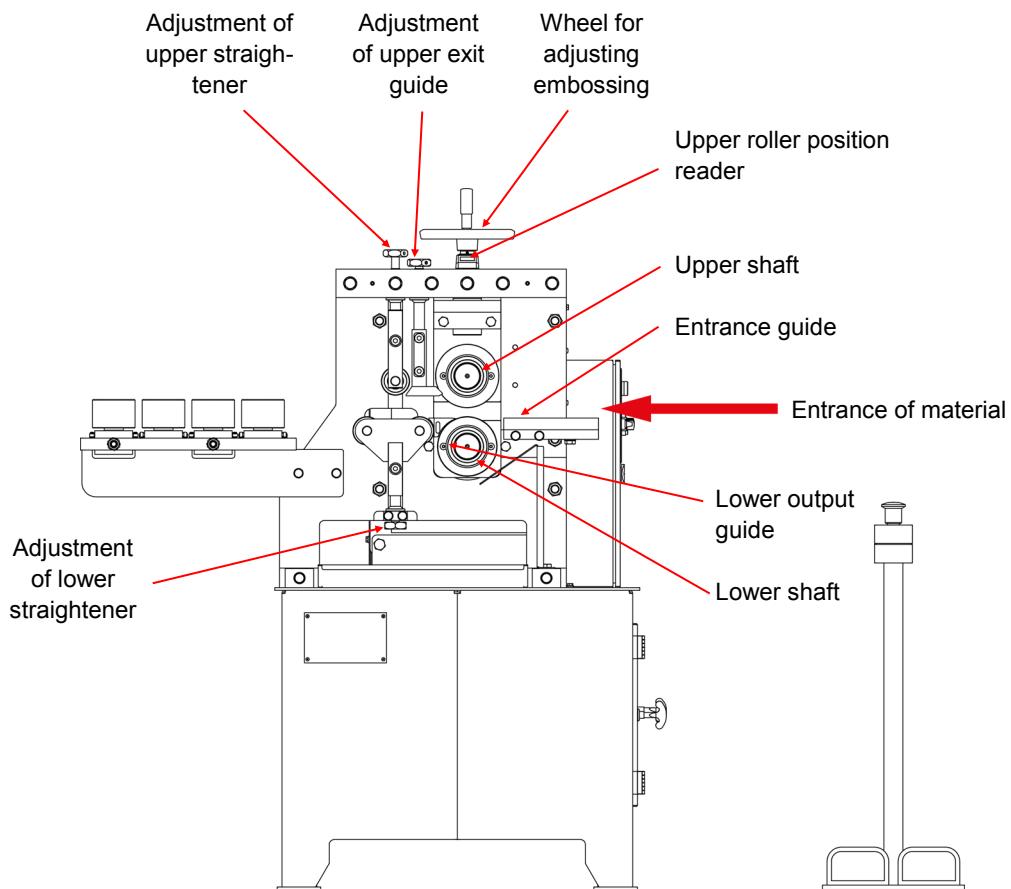
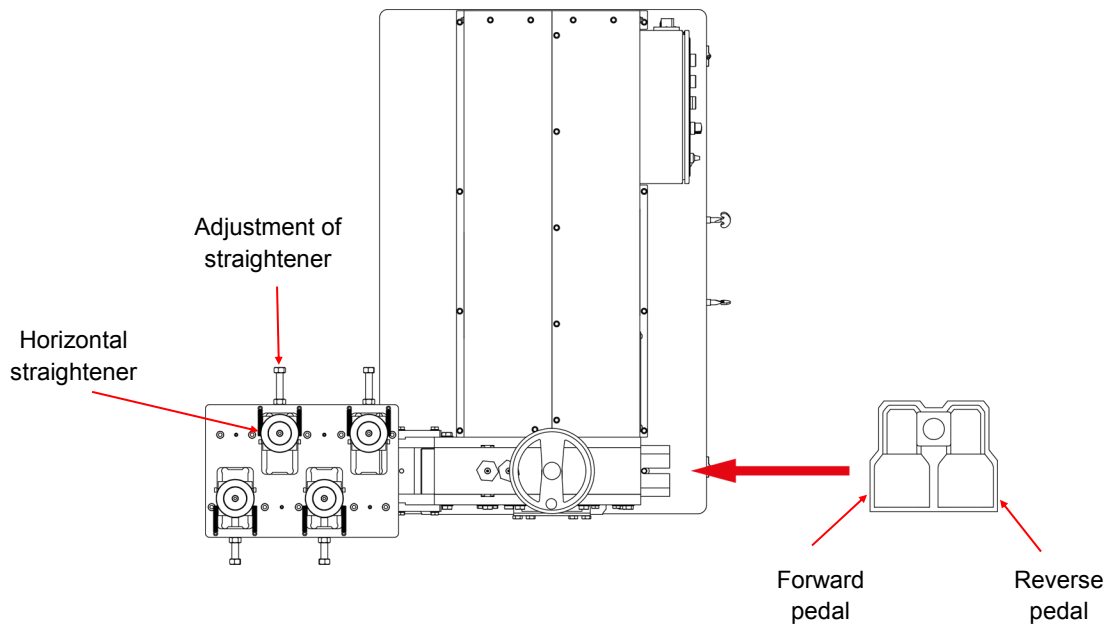

To adjust the Nargesa NOA60 embossing machine, the first step is to choose manual operation mode, as described in section 5.3.1.

Once the manual operation mode has been chosen and the desired rollers fitted, we will proceed with the machine adjustment:

- Using the Embossing Adjustment Wheel, raise the upper shaft as high as it will go. - Raise the upper straightener roller as high as it will go. - Raise the upper exit guide.
- Lower the straightener rollers to their lowest position.
- Open the horizontal straighteners completely.
- Insert the bar of material you wish to emboss and check that there is no interference with the vertical and horizontal straighteners.
- Then, with the aid of the adjustment wheel, lower the embossing roller to press on the para material. You may have to lower the upper output guide to avoid interference with the roller.
- Once you feel pressure on the material, press the forward pedal for the machine to begin embossing.
- When the material comes out of the other end, observe the depth of the marking, if you want deeper embossing, press the reverse pedal until the material is released from the roller.
- Use the Adjustment Wheel to make deeper markings and press the forward pedal again. Repeat this action until the desired marking on the material is obtained.
- When the desired marking has been achieved, raise the lower straightener rollers until they touch the material without force. Carry out the same operation with the upper roller and with the output guide.
- If, when embossed, you observe that the material is curved vertically, proceed to adjust the upper and lower straighteners until the material comes out flat.
- If you observe a horizontal curve, adjust the horizontal straightener rollers until the material comes out straight.

When all this has been done, the NARGESA NOA60 is ready for production in the Continuous/Automatic operation mode.

NOTE: Never adjust the force of the embossing rollers when they are pressing on the material, as this could damage the rollers.

6. WARNINGS

- Do not manipulate any component on the machine when it is in operation.
- Do not use the machine for any purpose apart from those described in this manual.
- Use gloves when handling the machine components and during the work processes.
- Use goggles and homologated protective boots.
- Hold the base material.
- Do not use the machine without its protective elements fitted

NARGESA SL will not be held liable for any accident caused by negligence on the part of the worker, for not following the use and safety instructions presented in this manual.

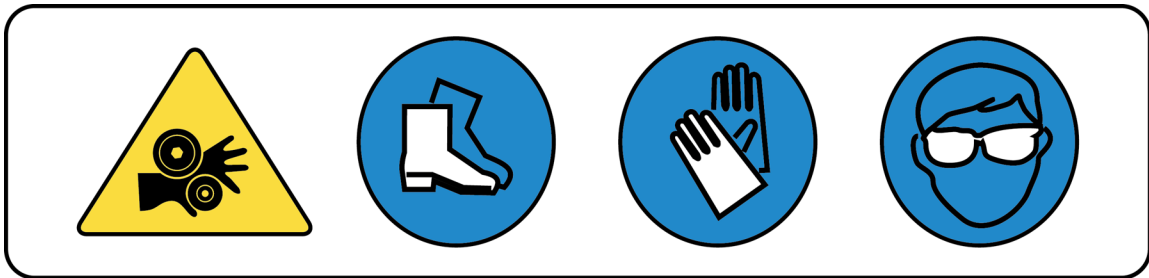

7. TOOLING

► Embossing roller 01

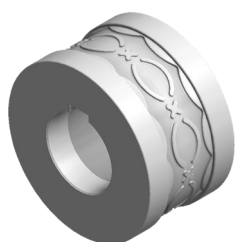

Reference: 140-11-01-00001.40

Roller to emboss a 40 mm or 1"-1/2 inches handrail
 Guide 140-11-01-00401 or 140-11-01-00402 is required
Ask the manufacturer about different dimensions

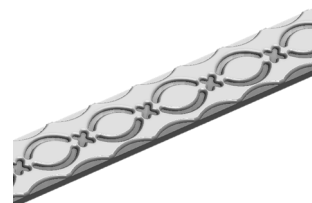

Units per machine	Material thickness	Weight
1	From 6 to 10mm	6,5 Kg

► Embossing roller 02



Reference: 140-11-01-00002.40

Roller to emboss a 40 mm or 1"-1/2 inches handrail
 Guide 140-11-01-00401 or 140-11-01-00402 is required
Ask the manufacturer about different dimensions



Units per machine	Material thickness	Weight
1	From 6 to 10mm	6,5 Kg

► Embossing roller 03

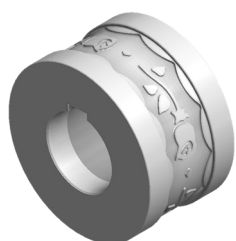

Reference: 140-11-01-00003.40

Roller to emboss a 40 mm or 1"-1/2 inches handrail
 Guide 140-11-01-00401 or 140-11-01-00402 is required
Ask the manufacturer about different dimensions



Units per machine	Material thickness	Weight
1	From 6 to 10mm	6,5 Kg

► Embossing roller 04

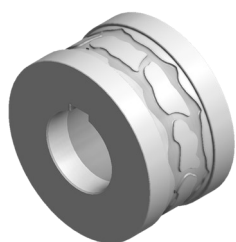

Reference: 140-11-01-00004.40

Roller to emboss a 40 mm or 1"-1/2 inches handrail
 Guide 140-11-01-00401 or 140-11-01-00402 is required
Ask the manufacturer about different dimensions

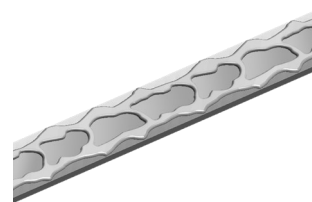

Units per machine	Material thickness	Weight
1	From 6 to 10mm	6,5 Kg

► **Embossing roller 05**

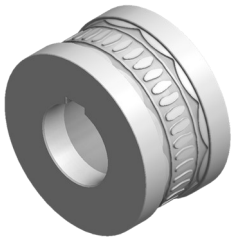

Reference: 140-11-01-00005.40

Roller to emboss a 40 mm or 1"-1/2 inches handrail

Guide 140-11-01-00401 or 140-11-01-00402 is required

Ask the manufacturer about different dimensions

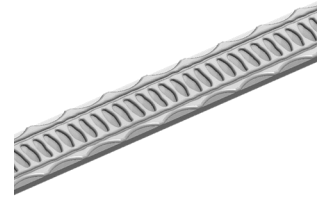

Units per machine	Material thickness	Weight
1	From 6 to 10mm	6,5 Kg

► **Embossing roller 06**



Reference: 140-11-01-00006.40

Roller to emboss a 40 mm or 1"-1/2 inches handrail

Guide 140-11-01-00401 or 140-11-01-00402 is required

Ask the manufacturer about different dimensions



Units per machine	Material thickness	Weight
1	From 6 to 10mm	6,5 Kg

► **Embossing roller 07**



Reference: 140-11-01-00007.40

Roller to emboss a 40 mm or 1"-1/2 inches handrail

Guide 140-11-01-00401 or 140-11-01-00402 is required

Ask the manufacturer about different dimensions



Units per machine	Material thickness	Weight
1	From 6 to 10mm	6,5 Kg

► **Embossing roller 08**



Reference: 140-11-01-00008.40

Roller to emboss a 40 mm or 1"-1/2 inches handrail

Guide 140-11-01-00401 or 140-11-01-00402 is required

Ask the manufacturer about different dimensions

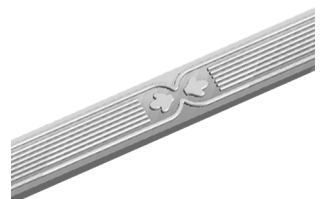

Units per machine	Material thickness	Weight
1	From 6 to 10mm	6,5 Kg

► **Embossing roller 09**

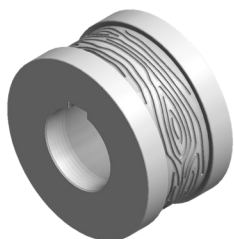

Reference: 140-11-01-00009

Roller to emboss handrail up to 60 mm

Guide 140-11-01-00401, 140-11-01-00402 or 140-11-01-00400 is required

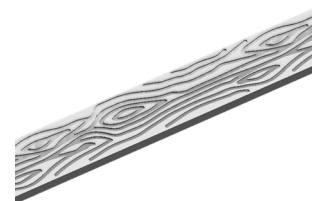

Units per machine	Material thickness	Weight
1	From 6 to 10mm	6,1 Kg

► **Embossing roller 10**



Reference: 140-11-01-00010.40

Roller to emboss a 40 mm or 1"-1/2 inches handrail

Guide 140-11-01-00401 or 140-11-01-00402 is required

Ask the manufacturer about different dimensions



Units per machine	Material thickness	Weight
1	From 6 to 10mm	6,5 Kg

► **Embossing roller 11**



Reference: 140-11-01-00011.40

Roller to emboss a 40 mm or 1"-1/2 inches handrail

Guide 140-11-01-00401 or 140-11-01-00402 is required

Ask the manufacturer about different dimensions



Units per machine	Material thickness	Weight
1	From 6 to 10mm	6,5 Kg

► **Embossing roller 12**

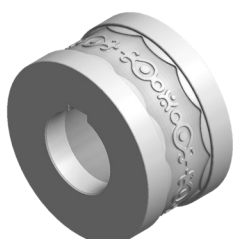

Reference: 140-11-01-00012.40

Roller to emboss a 40 mm or 1"-1/2 inches handrail

Guide 140-11-01-00401 or 140-11-01-00402 is required

Ask the manufacturer about different dimensions



Units per machine	Material thickness	Weight
1	From 6 to 10mm	6,5 Kg

► **Embossing roller 13**



Reference: 140-11-01-00013.40

Roller to emboss a 40 mm or 1"-1/2 inches handrail
 Guide 140-11-01-00401 or 140-11-01-00402 is required
 Ask the manufacturer about different dimensions

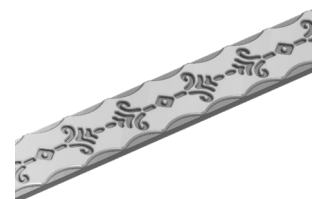

Units per machine	Material thickness	Weight
1	From 6 to 10mm	6,5 Kg

► **Embossing roller 14**



Reference: 140-11-01-00014.40

Roller to emboss a 40 mm or 1"-1/2 inches handrail
 Guide 140-11-01-00401 or 140-11-01-00402 is required
 Ask the manufacturer about different dimensions



Units per machine	Material thickness	Weight
1	From 6 to 10mm	6,5 Kg

► **Embossing roller 15**



Reference: 140-11-01-00015.40

Roller to emboss a 40 mm or 1"-1/2 inches handrail
 Guide 140-11-01-00401 or 140-11-01-00402 is required
 Ask the manufacturer about different dimensions

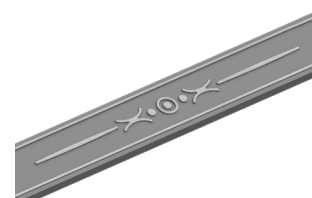

Units per machine	Material thickness	Weight
1	From 6 to 10mm	6,4 Kg

► **Embossing roller 16**



Reference: 140-11-01-00016.40

Roller to emboss a 40 mm or 1"-1/2 inches handrail
 Guide 140-11-01-00401 or 140-11-01-00402 is required
 Ask the manufacturer about different dimensions



Units per machine	Material thickness	Weight
1	From 6 to 10mm	6,4 Kg

► **Embossing roller 17**



Reference: 140-11-01-00017.40

Roller to emboss a 40 mm or 1"-1/2 inches handrail

Guide 140-11-01-00401 or 140-11-01-00402 is required

Ask the manufacturer about different dimensions



Units per machine	Material thickness	Weight
1	From 6 to 10mm	6,4 Kg

► **Embossing roller 18**

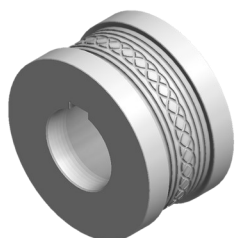

Reference: 140-11-01-00018.40

Roller to emboss a 40 mm or 1"-1/2 inches handrail

Guide 140-11-01-00401 or 140-11-01-00402 is required

Ask the manufacturer about different dimensions

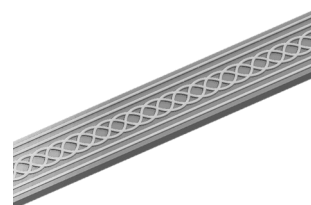

Units per machine	Material thickness	Weight
1	From 6 to 10mm	6,4 Kg

► **Embossing roller 19**



Reference: 140-11-01-00019.40

Roller to emboss a 40 mm or 1"-1/2 inches handrail

Guide 140-11-01-00401 or 140-11-01-00402 is required

Ask the manufacturer about different dimensions



Units per machine	Material thickness	Weight
1	From 6 to 10mm	6,4 Kg

► **Embossing roller 20**



Reference: 140-11-01-00020.40

Roller to emboss a 40 mm or 1"-1/2 inches handrail

Guide 140-11-01-00401 or 140-11-01-00402 is required

Ask the manufacturer about different dimensions

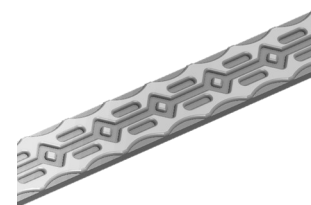

Units per machine	Material thickness	Weight
1	From 6 to 10mm	6,5 Kg

► **Embossing roller 21**



Reference: 140-11-01-00021.50

Roller to emboss a 50 mm or 2" inches handrail
 Guide 140-11-01-00401 or 140-11-01-00402 is required
 Ask the manufacturer about different dimensions

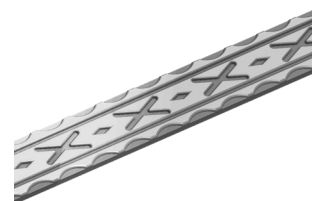

Units per machine	Material thickness	Weight
1	From 6 to 10mm	6,4 Kg

► **Embossing roller 22**



Reference: 140-11-01-00022.40

Roller to emboss a 40 mm or 1"-1/2 inches handrail
 Guide 140-11-01-00401 or 140-11-01-00402 is required
 Ask the manufacturer about different dimensions



Units per machine	Material thickness	Weight
1	From 6 to 10mm	6,4 Kg

► **Embossing roller 23**

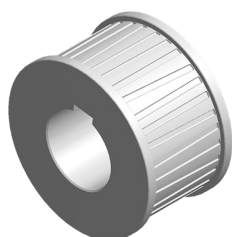

Reference: 140-11-01-00023

Roller to emboss handrail up to 60 mm
 Guide 140-11-01-00401, 140-11-01-00402,
 140-11-01-00400 or 140-11-01-00300 is required

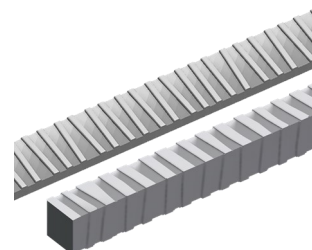

Units per machine	Material thickness	Weight
1	From 6 to 10mm	6 Kg

► **Embossing roller 24**



Reference: 140-11-01-00024.40

Roller to emboss a 40 mm or 1"-1/2 inches handrail
 Guide 140-11-01-00401 or 140-11-01-00402 is required
 Ask the manufacturer about different dimensions



Units per machine	Material thickness	Weight
1	From 6 to 10mm	6,4 Kg

► **Embossing roller 25**

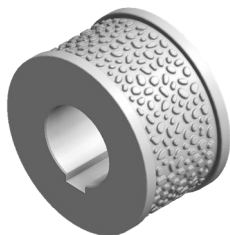

Reference: 140-11-01-00025

Roller to emboss handrail up to 60 mm

Guide 140-11-01-00401, 140-11-01-00402 or

140-11-01-00400 is required

Ask the manufacturer about different dimensions

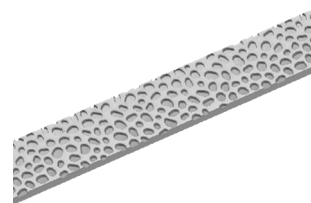

Units per machine	Material thickness	Weight
1	From 6 to 10mm	6,3 Kg

► **Roller for the side marking of flat bar**



Reference: 140-11-01-00028

Sectioned roller to emboss different flat bar sizes on the same kit. Adjustable to flat bars of 25mm o 1", 30mm o 1" 1/4, 40mm o 1" 1/2 and 50mm o 2".

Guide 140-11-01-00401, 140-11-01-00402, 140-11-01-00403 or 140-11-01-00404 is required

Ask the manufacturer about different dimensions

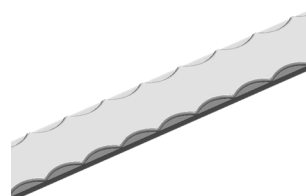

Units per machine	Material thickness	Weight
1	From 5 to 12mm	12,5 Kg

► **Entrance guide for 60 mm handrail**

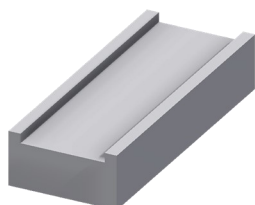

Reference: 140-11-01-00400

Entrance guide for 60 mm handrail.

Weight: 4,3 Kg

► **Entrance guide for 40 and 50 mm handrail**

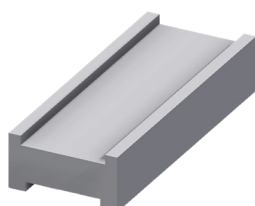

Ref: 140-11-01-00401

Inlet guide for 40 and 50 mm handrail

Weight: 4 Kg

▶ Entrance guide for 1" 1/2 and 2" inches handrail

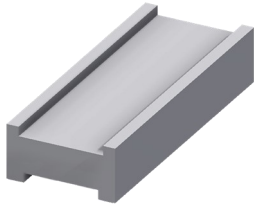

Ref: 140-11-01-00402

Inlet guide for 1" 1/2 and 2" inches handrail.

Weight: 4 Kg

▶ Entrance guide for 25 and 30mm handrail

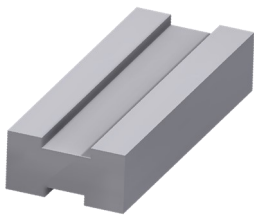

Ref: 140-11-01-00403

Inlet guide for 25 and 30 mm handrail.

Weight: 4,300 Kg

▶ Entrance guide for 1" and 1" 1/4 inches handrail

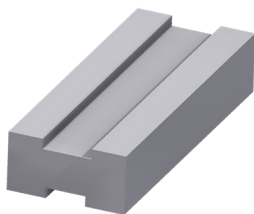

Ref: 140-11-01-00404

Inlet guide for 1" and 1" 1/4 inches handrail.

Weight: 4,300 Kg

► **Embossing roller 201**

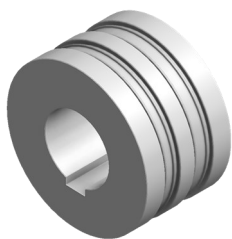

Reference: 140-11-01-00201

Roller to emboss 12 and 15 mm or 1/2 inch handrail.
For clamp forming
Guide 140-11-01-00200 is required
Ask the manufacturer about different dimensions

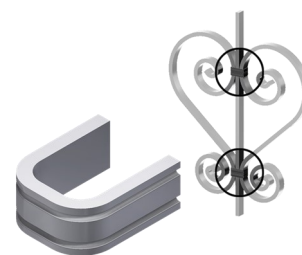

Units per machine	Material thickness	Weight
1	From 6 to 10mm	6,5 Kg

► **Embossing roller 202**

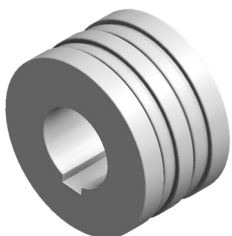

Reference: 140-11-01-00202

Roller to emboss 12 and 15 mm or 1/2 inch handrail.
For clamp forming
Guide 140-11-01-00200 is required
Ask the manufacturer about different dimensions

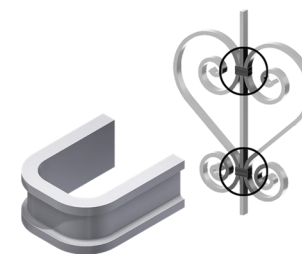

Units per machine	Material thickness	Weight
1	From 6 to 10mm	6,6 Kg

► **Entrance guide for 12mm or 1/2" inch and 15 mm handrail**

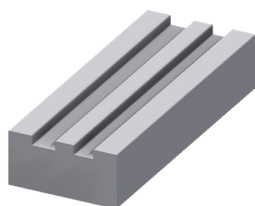

Reference: 140-11-01-00200

Entrance guide for 12 mm and 15 mm or 1/2" inch handrail
Weight: 4,6 Kg

► **Set of embossing rollers 26**

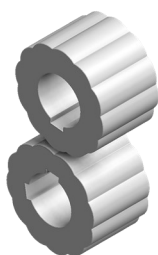

Reference: 140-11-01-00026

Rollers to emboss handrail up to 60 mm and square bar up to 20 mm or 3/4" inch
Guide 140-11-01-00401, 140-11-01-00402, 140-11-01-00400 o 140-11-01-00300 is required
To emboss edge square bar, an entrance guide is required 140-11-01-00027
Ask the manufacturer about different dimensions

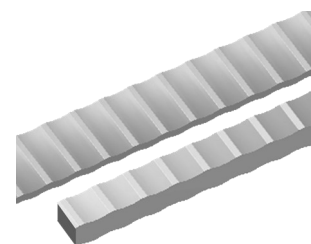

Set per machine	Material thickness	Weight
1	---	11,4 Kg

▶ Entrance guide for edge square bar

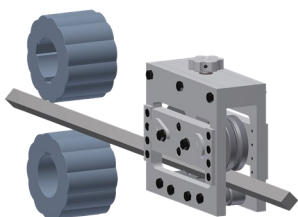

Reference: 140-11-01-00027

Entrance guide to emboss edge square bar up to 20mm or 3/4" inch

Set of embossing rollers 140-11-01-00026 is required

Weight: 18 Kg

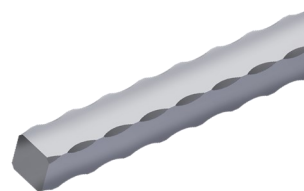

▶ Set of embossing rollers 302



Reference: 140-11-01-00302

Rollers to emboss square bar up to 12 mm or 1/2", 16 mm or 5/8" and 18 mm.

Guide 140-11-01-00300 is required

Ask the manufacturer about different dimensions

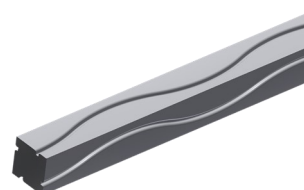

Set per machine	Material thickness	Weight
1	—	12,6 Kg

▶ Set of embossing rollers 303



Reference: 140-11-01-00303

Rollers to emboss square bar up to 10 mm or 3/8", 14 mm or 9/16" and 20 mm or 3/4" inch

Guide 140-11-01-00300 is required

Ask the manufacturer about different Ask the manufacturer

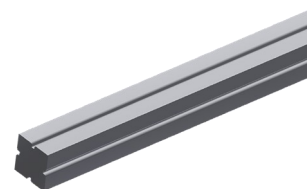

Units per machine	Material thickness	Weight
1	—	12,9 Kg

▶ Set of embossing rollers 304



Reference: 140-11-01-00304

Rollers to emboss square bar up to 12 mm or 1/2", 16 mm or 5/8" and 18 mm.

Guide 140-11-01-00300 is required

Ask the manufacturer about different dimensions

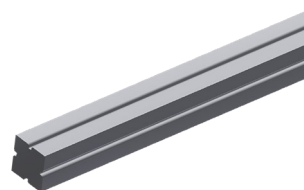

Units per machine	Material thickness	Weight
1	—	12,9 Kg

▶ Set of embossing rollers 301



Reference: 140-11-01-00301

Rollers to emboss square bar up to 10 mm or 3/8", 14 mm or 9/16" and 20 mm or 3/4" inch

Guide 140-11-01-00300 is required

Ask the manufacturer about different dimensions

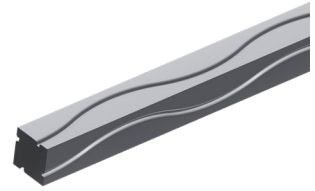

Set per machine	Material thickness	Weight
1	---	12,6 Kg

▶ Entrance guide for square bar



Reference: 140-11-01-00300

Entrance guide for square bar of 10mm or 3/8", 12mm or 1/2", 14mm or 9/16", 16mm or 5/8", 18mm and 20 mm or 3/4" inch

Weight: 4 Kg

► Set of embossing rollers for 25 mm or 1", 30 mm or 1" 1/4, 35 and 40 mm pipes



Ref: 140-11-01-00500

Set of sectioned rollers to emboss different square or rectangular pipe sizes with the same set. Adjustable to the following pipes:

Square pipes: 25mm or 1", 30mm or 1" 1/4, 35 and 40mm

Rectangular pipes: 25x20mm or 1"x3/4", 30x20mm or 1"1/4x3/4", 30x25mm, 35x20mm, 35x25mm, 40x20mm, 40x25mm, 40x30mm, 40x35mm

Guide 140-11-01-00501 or 140-11-01-00502 is required

Ask the manufacturer about different dimensions

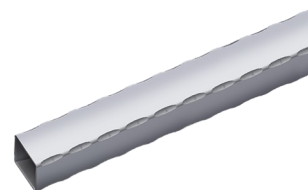

Set per machine	Material minimum thickness suggested by manufacturer	Weight
1	3 mm	12 Kg

► Inlet guide for 25 mm or 1" and 30 mm or 1" 1/4 Pipe

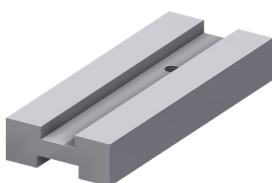

Ref: 140-11-01-00501

Inlet guide for 25 mm or 1" and 30 mm or 1" 1/4 pipe

Weight: 3 Kg

► Inlet guide for 35 and 40 mm pipe

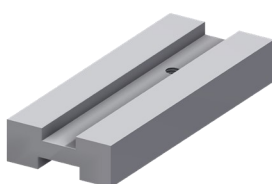

Ref: 140-11-01-00502

Inlet guide for 35 and 40 mm pipe

Weight: 2,8 Kg

▶ Set of embossing rollers for 50 and 60mm pipes



Ref: 140-11-01-00503

Set of sectioned rollers to emboss different square or rectangular pipe sizes with the same set. Adjustable to the following pipes:

Square pipes: 50mm or 60mm

Rectangular pipes: 50x20mm, 50x25mm, 50x30mm, 50x35mm, 50x40mm, 50x45mm, 60x20mm, 60x25mm, 60x30mm, 60x35mm, 60x40mm, 60x45mm, 60x50mm or 60x55mm

Guide 140-11-01-00505 or 140-11-01-00506 is required

Ask the manufacturer about different dimensions

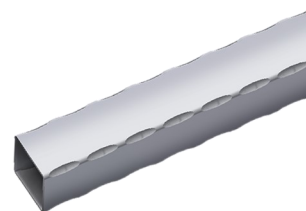

Set per machine	Material minimum thickness suggested by manufacturer	Weight
1	3 mm	6 Kg

▶ Inlet guide for 50 mm pipe



Ref: 140-11-01-00505

Inlet guide for 50 mm pipe

Weight: 2,4 Kg

▶ Inlet guide for 60 mm pipe



Ref: 140-11-01-00506

Inlet guide for 60 mm pipe

Weight: 2,2 Kg

► Set of embossing rollers for 1" 1/2, 2" and 2" 1/2 inches pipes



Ref: 140-11-01-00507

Set of sectioned rollers to emboss different square or rectangular pipe sizes with the same set. Adjustable to the following pipes:

Square pipes: 1" 1/2, 2" and 2" 1/2 inches

Rectangular pipes: 1"1/2x3/4", 1"1/2x1", 2"x1", 2"x1"1/4, 2"x1"1/2, 2"1/2x1"1/2 inches

Guide 140-11-01-00508, 140-11-01-00509

or 140-11-01-00510 is required

Ask the manufacturer about different dimensions

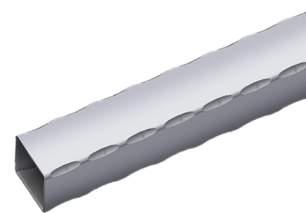

Set per machine	Material minimum thickness suggested by manufacturer	Weight
1	3 mm	6 Kg

► Inlet guide for 1" 1/2 inches pipe



Ref: 140-11-01-00508

Inlet guide for 1" 1/2 inches pipe

Weight: 2,6 Kg

► Inlet guide for 2" inches pipe



Ref: 140-11-01-00509

Inlet guide for 2" inches pipe

Weight: 2,4 Kg

► Inlet guide for 2" 1/2 inches pipe



Ref: 140-11-01-00510

Inlet guide for 2" 1/2 inches pipe

Weight: 2,2 Kg

► Rollerstand

**Ref: 140-00-00-00004**

Seven-rollers stand

Ask the manufacturer about different dimensions

Working Height	Dimensions	Load capacity	Weight
650 / 1200 mm	2050x470 mm	800 Kg	65 Kg











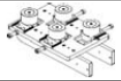







Technical annexe







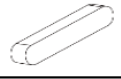











NOA60 Embossing machine



















Exploded view
Horizontal straightener assembly
Horizontal straightener roller assembly
Lower straightener assembly
Moving straightener roller
Upper straightener assembly
Gearbox assembly
Electrical diagrams











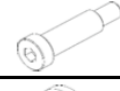

A1. Exploded view

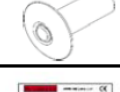

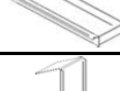
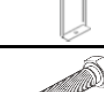
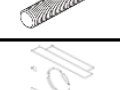
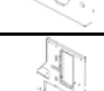
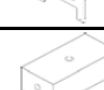
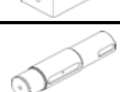
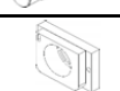



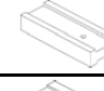
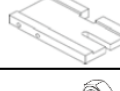

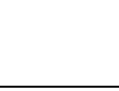











100-11-01-003	Nº Despiece		Nombre	Fecha
		PLANO DE ENSAMBLAJE	tecnic20	22/11/2017
		MAQUINA DE GRABAR	Dibujado	Verificado
		Ref. del ensamblaje		
	Tratamiento	100-11-01-002		
	Revestimiento	NOA60		
		Maq.		
		<small>Cita de Compra a Serri Maquinas S.L. (Girona) http://www.nargesa.com</small>		
Este plano es propiedad de Prada Nargesa S.L. No podrá ser reproducido, comunicado a terceros o utilizado para otro fin que no sea el acordado sin su permiso escrito.				

Nº ORDEN	DIBUJO	DESCRIPCION	Nº PLANO	CANTIDAD
1		CONJUNTO ENDEREZADOR HORIZONTAL	130-11-01-00308	1
2		CONJUNTO ENDEREZADOR INFERIOR	130-11-01-00306	1
3		CONJUNTO VARILLA ROSCADA ENDEREZADOR INFERIOR	130-11-01-00302	1
4		SEPARADOR INFERIOR ENDEREZADOR	120-11-01-00372	1
5		ESPARRAGO ALLEN DIN 913 M8X12	020-D913-M8X12	3
6		HEXAGONAL ACCIONAMIENTO	120-11-01-00369	3
7		CONJUNTO ENDEREZADOR SUPERIOR	130-11-01-00305	1
8		CONJUNTO VARILLA ROSCADA ENDEREZADOR SUPERIOR	130-11-01-00303	1
9		ARANDELA APOYO VARILLAS SUPERIORES	120-11-01-00391	2
10		CIRCLIP DE EJE DIN 471 Ø16	030-D471-00003	2
11		CONJUNTO VARILLA ROSCADA PATIN ENTRADA SUPERIOR	130-11-01-00313	1
12		SOPORTE PATIN SUPERIOR ENTRADA	120-11-01-00386	1
13		PATIN SUPERIOR ENTRADA ENDEREZADOR	120-11-01-00385	1
14		TORNILLO ALLEN DIN 912 M12X25	020-D912-M12X25	2
15		UNION MOVIL SUPERIOR	120-11-01-00313	1
16		EJE PRINCIPAL MOVIMIENTO VERTICAL	120-11-01-00314	1
17		ARANDELA APOYO EJE PRINCIPAL	120-11-01-00392	1
18		CHAVETA PARALELA DIN 6885 A 6X6X18	030-D6885A-00031	1
19		VOLANTE ACCIONAMIENTO NOA60	120-11-01-00394	1
20		ESPARRAGO ALLEN DIN 913 M6X12	020-D913-M6X12	1

Nº ORDEN	DIBUJO	DESCRIPCION	Nº PLANO	CANTIDAD
21		CONTADOR DD52R-AR-0002.0-S-C3	031-CON-00003	1
22		CIRCLIP EJE DIN 471 Ø25	030-D471-00008	1
23		ARANDELA DIN 125 B M12	020-D125B-M12	7
24		TORNILLO HEXAGONAL DIN 933 M12X40	020-D933-M12X40	8
25		ARANDELA DIN 125 B M10	020-D125B-M10	12
26		TORNILLO HEXAGONAL DIN 933 M10X35	020-D933-M10X35	12
27		SOPORTE FRONTAL TAPA FIJA	120-11-01-00364	1
28		TORNILLO HEXAGONAL EMBRIDADO M6X12	020-D6921-M6X12	25
29		CONJUNTO TAPA FIJA NOA60	130-11-01-00311	1
30		TAPA DERECHA MAQUINA DE GRABAR	120-11-01-00351	1
31		TAPA ZONA ENGRASE	120-11-01-00363	1
32		CALCA ADVERTENCIAS NOA60	122-CAL-1101-002	2
33		TORNILLO ISO 7380 M6X10	020-I7380-M6X10	4
34		ACOPLAMIENTO TRACCION LADO MAQUINA	120-11-01-00329	1
35		ESPARRAGO ALLEN DIN 913 M6X6	020-D913-M6X6	1
36		ACOPLAMIENTO CENTRAL TRACCION	120-11-01-00330	1
37		ACOPLAMIENTO TRACCION LADO REDUCTOR	120-11-01-00325	1
38		CONJUNTO REDUCTOR NOA60	130-11-01-00323	1
39		TAPA TRASERA NOA60	120-11-01-00352	1
40		ACOPLAMIENTO TRACCION INFERIOR	130-11-01-00301	1

Nº ORDEN	DIBUJO	DESCRIPCION	Nº PLANO	CANTIDAD
41		ESPARRAGO ALLEN DIN 913 M10X20	020-D913-M10X20	4
42		ENGRASADOR DIN 71412 M8 RECTO	020-D71412-M8 RECTO	1
43		TUERCA HEXAGONAL DIN 934 M18	020-D934-M18	11
44		PLACA INTERIOR	120-11-01-00317	1
45		BARRA SEPARADORA PASANTE	120-11-01-00343	5
46		BARRA SEPARADORA ROSCADA	120-11-01-00344	1
47		TORNILLO HEXAGONAL DIN 933 M14X45 8.8 PAVONADO	020-D933-M14X45	12
48		ARANDELA DIN 125 1B M14	020-D125B-M14	12
49		GUIA SALIDA PASAMANO	120-11-01-00382	1
50		TORNILLO HEXAGONAL DIN 931 M12X65	020-D931-M12x65	4
51		TORNILLO HEXAGONAL DIN 931 M12X55	020-D931-M12X55	4
52		GUIA EXTERIOR	120-11-01-00318	2
53		COJINETE DE RODILLOS DOBLE SL045011PP	030-CJ-00024	4
54		GRUESO LATERAL DE BRONCE	120-11-01-00402	4
55		RODILLO INFERIOR MAQUINA DE GRABAR	120-11-01-00308	1
56		CHAVETA PARALELA DIN6885A 16X10X50	030-D6885A-00029	2
57		CHAVETA EJES PRINCIPALES	120-11-01-00354	2
58		TORNILLO ALLEN DIN 6912 M6X16	020-D6912-M6X16	18
59		PASADOR CILINDRICO DIN 7979D D8X40	030-D7979D-00006	4
60		SOPORTE SUPERIOR	120-11-01-00316	1



Nº ORDEN	DIBUJO	DESCRIPCION	Nº PLANO	CANTIDAD
61		SOPORTE SUPERIOR EXTERIOR	120-11-01-00420	2
62		PLACA APOYO EXTERIOR GUIA PATIN SUPERIOR	120-11-01-00387	1
63		TORNILLO GUIA ISO 7379 D14X40	020-I7379-D14X40	4
64		ARANDELA GUIA EXTERIOR ENDEREZADORES	120-11-01-00393	2
65		REMACHE DE CLAVO DIN 7337 DE AL Ø3X8	020-D7337-3X8	4
66		PLACA CARACTERISTICAS NOA60	122-PLC-1101-001	1
67		CAJON RECOGEDOR	120-11-01-00370	1
68		TAPA PROTECCION FRONTAL INFERIOR	120-11-01-00373	1
69		TORNILLO HEXAGONAL DIN 933 M12X20	020-D933-M12X20	1
70		SOPORTE INFERIOR EXTERIOR	120-11-01-00419	1
71		PLACA EXTERIOR	120-11-01-00315	1
72		SOPORTE INFERIOR	120-11-01-00338	2
73		EJE MAQUINA DE GRABAR	120-11-01-00309	2
74		SOPORTE INFERIOR INTERIOR	120-11-01-00418	1
75		TORNILLO HEXAGONAL DIN 933 M14X35	020-D933-M14X35	2
76		TUERCA DIN 934 M14	020-D934-M14	4
77		KIT INSTALACION ELECTRICA MAQUINA DE GRABAR	050-KIE-1101-001	1
78		GUIA ENTRADA PASAMANO 50/40	120-11-01-00366	1
79		GUIA MATERIAL ENTRADA	120-11-01-00326	1
80		TORNILLO HEXAGONAL DIN 933 M12X25	020-D933-M12X25	5

Nº ORDEN	DIBUJO	DESCRIPCION	Nº PLANO	CANTIDAD
81		CONJUNTO ESTRUCTURA MAQUINA DE GRABAR	130-11-01-00307	1
82		PUERTA IZQUIERDA MAQUINA GRABAR	120-11-01-00360	1
83		PUERTA DERECHA MAQUINA DE GRABAR	120-11-01-00361	1
84		CIERRE DE LENGÜETA CON TRIANGULO 8 M20	031-CLT-00001	2
85		LLAVE PARA CIERRE TRIANGULO DE 8 FLOTANTE NIQUELADA	031-LLT-00001	2
86		TORNILLO ALLEN DIN 7991 M6X16	020-D7991-M6X16	8
87		TORNILLO ALLEN DIN 7991 M6X25	020-D7991-M6X25	8
88		GRUESO PUERTA	120-12-02-00125	4
89		BISAGRA DE PLASTICO 30 ENTRE CENTROS	031-BP-00001	4
90		TUERCA DIN 934 M12	020-D934-M12	2
91		SOPORTE DELANTERO MAQUINA	120-12-02-00187	1
92		PEDAL DOBLE CON PARO DE EMERGENCIA	050-PED-00002	1
93		CIRCLIP EJE DIN471 D55	030-D471-00015	2
94		TORNILLO ISO 7380 M6X12	020-I7380-M6X12	3
95		POMO MACHO ESTRELLA MATE Ø28 M6X10	031-POMM-00002	1
96		PROTECCION SUPERIOR ENTRADA NOA60	120-11-01-00395	1
97		ASA PUENTE 145X40 2117	031-APM-00003	3
98		TORNILLO ALLEN DIN 912 M8X20	020-D912-M8X20	6
99		TUERCA DIN 934 M6	020-D934-M6	8
100		TORNILLO HEXAGONAL DIN 933 M14X40	020-D933-M14X40	2

A2. Horizontal straightener assembly

<p>130-11-01-00308</p>	<p>Nº Despiece</p>		<p>Nombre Tecnico20</p>	<p>Fecha 18/03/2015</p>
		<p>PLANO DE ENSAMBLAJE</p>	<p>Dibujado Verificado</p>	
		<p>CONJUNTO ENDEREZADOR HORIZONTAL</p>	<p>Ref. del ensamble 130-11-01-00308</p>	
		<p>Trazado Revestimiento</p>	<p>Maq. N/A60</p>	
			<p>100-11-01-002</p>	
			<p>N/A60</p>	

Este plano es propiedad de Narga S.A. No puede ser reproducido, copiado, alterado o distribuido para otro fin que no sea el acordado en su primer hecho.

Nº ORDEN	DIBUJO	DESCRIPCION	Nº PLANO	CANTIDAD
1.01		SOPORTE FRONTAL ENDEREZADOR TRASERO	120-11-01-00328	1
1.02		SOPORTE TRASERO ENDEREZADOR TRASERO	120-11-01-00327	1
1.03		TORNILLO REGULACION ENDEREZADORES HORIZONTALES	120-11-01-00417	4
1.04		TUERCA DIN 934 M16	020-D934-M16	4
1.05		MUELLE TRACCION D10X1.5 DERECHO	120-11-01-00378	4
1.06		CONJUNTO RODILLO ENDEREZADOR HORIZONTAL	130-11-01-00309	4
1.07		PLACA BASE ENDEREZADOR TRASERO	120-11-01-00331	1
1.08		MUELLE TRACCION D10X1.5 IZQUIERDO	120-11-01-00377	4
1.09		PASADOR CILINDRICO DIN 7979D D8X40	030-D7979D-00006	4
1.10		TORNILLO ALLEN DIN 912 M6X16	020-D912-M6X16	8
1.11		TORNILLO ALLEN DIN 912 M10X25	020-D912-M10X25	10

A3. Horizontal straightener roller assembly

130-11-01-00309	N° Despiece									
PLANO DE ENSAMBLAJE										
CONJUNTO RODILLO ENDEREZADOR HORIZONTAL	<table border="1" style="width: 100%; border-collapse: collapse;"> <tr> <td style="width: 30%; padding: 2px;">Ref. del ensamblaje</td> <td style="width: 30%; padding: 2px;">Nombre</td> <td style="width: 40%; padding: 2px;">Fecha</td> </tr> <tr> <td style="padding: 2px;">130-11-01-00309</td> <td style="padding: 2px;">Tecnico20</td> <td style="padding: 2px;">18/03/2015</td> </tr> <tr> <td style="padding: 2px;">Dibujado</td> <td colspan="2" style="padding: 2px;">Verificado</td> </tr> </table>	Ref. del ensamblaje	Nombre	Fecha	130-11-01-00309	Tecnico20	18/03/2015	Dibujado	Verificado	
Ref. del ensamblaje	Nombre	Fecha								
130-11-01-00309	Tecnico20	18/03/2015								
Dibujado	Verificado									
<table border="1" style="width: 100%; border-collapse: collapse;"> <tr> <td style="width: 30%; padding: 2px;">Tratamiento</td> <td style="width: 30%; padding: 2px;">5,01 kg</td> <td style="width: 40%; padding: 2px;">Maq. 100-11-01-002</td> </tr> <tr> <td style="padding: 2px;">Revestimiento</td> <td colspan="2" style="padding: 2px;">NOA60</td> </tr> </table>	Tratamiento	5,01 kg	Maq. 100-11-01-002	Revestimiento	NOA60		<table border="1" style="width: 100%; border-collapse: collapse;"> <tr> <td style="text-align: center; padding: 5px;">N NARGESA®</td> </tr> <tr> <td style="font-size: 8px; padding: 2px;">Ctra. de Garrigás a Sant Miquel s/n 17476 Palau sta. Eulàlia (Girona) http://www.nargesa.com</td> </tr> </table>	N NARGESA®	Ctra. de Garrigás a Sant Miquel s/n 17476 Palau sta. Eulàlia (Girona) http://www.nargesa.com	
Tratamiento	5,01 kg	Maq. 100-11-01-002								
Revestimiento	NOA60									
N NARGESA®										
Ctra. de Garrigás a Sant Miquel s/n 17476 Palau sta. Eulàlia (Girona) http://www.nargesa.com										

Este plano es propiedad de Prada Nargesa SL. No podrá ser reproducido, comunicado a terceros o utilizado para otro fin que no sea el acordado sin su permiso escrito.

Nº ORDEN	DIBUJO	DESCRIPCION	Nº PLANO	CANTIDAD
1.06.01		TORNILLO ALLEN DIN 912 M8X25	020-D912-M8X25	4
1.06.02		TAPA RODILLO ENDEREZADOR HORIZONTAL	120-11-01-00337	4
1.06.03		RODILLO ENDEREZADOR HORIZONTAL	120-11-01-00333	4
1.06.04		CIRCLIP AGUJERO DIN472 D55X2	030-D472-00014	4
1.06.05		RODAMIENTO DE RODILLOS DOBLE SL04506PP	030-CJ-00025	4
1.06.06		EJE RODILLO ENDEREZADOR HORIZONTAL	120-11-01-00336	4
1.06.07		SOPORTE RODILLO ENDEREZADOR HORIZONTAL	120-11-01-00334	4
1.06.08		TORNILLO ALLEN DIN 912 M6X16	020-D912-M6X16	8
1.06.09		TAPA INFERIOR ENDEREZADOR HORIZONTAL	120-11-01-00335	4
1.06.10		TORNILLO ALLEN DIN 7991 M10X30	020-D7991-M10X30	16
1.06.11		TORNILLO ALLEN DIN 7991 M8X25	020-D7991-M8X25	4

A4. Lower straightener assembly





130-11-01-00306	N° Despiece		
		<p>PLANO DE ENSAMBLAJE</p> <p>Ref. del ensamblaje 130-11-01-00306</p>	<p>Nombre Técnic20</p> <p>Fecha 12/05/2015</p>
		<p>Conjunto Enderezador Inferior</p>	<p>Dibujado Verificado</p>
		<p>Tratamiento Revestimiento</p>	<p>Maq. NOA60</p>
		<p>N/D</p>	<p>100-11-01-002 NOA60</p>
<p>N NARGESA®</p> <p><small>Ctra. de Corrigós a Soria, km. 7,276 Pol. Ind. Eulalia (girona) 49100 NARGESA (Vizcaya)</small></p> <p><small>Este plano es propiedad de Fransa Nargesa S.L. No podrá ser reproducido, comunicado a terceros o utilizado para otro fin que no sea el acordado sin su permiso escrito.</small></p>			

Nº ORDEN	DIBUJO	DESCRIPCION	Nº PLANO	CANTIDAD
2.01		ESTRUCTURA ENDEREZADOR INFERIOR	130-11-01-00306-FM1	1
2.02		RODILLO ENDEREZADOR MOVIL	130-11-01-00304	2
2.03		ESPARRAGO ALLEN DIN 913 M6X12	020-D913-M6X12	2
2.04		PATIN INTERMEDIO	120-11-01-00379	1
2.05		TORNILLO ALLEN DIN 912 M10X25	020-D912-M10X25	2
2.06		EJE RODILLO ENDEREZADOR DOBLE	120-11-01-00347	2

A5. Moving straightener roller

130-11-01-00304	N° Despiece		
PLANO DE ENSAMBLAJE		Ref. del ensamblaje 130-11-01-00304	Nombre Técnic20
RODILLO ENDEREZADOR MOVIL		Dibujado Verificado	Fecha 08/07/2015
	Tratamiento 1,14 kg	Maq. 100-11-01-002 NOA60	
Revestimiento		<small>Ctra. de Carriños a S.º de M.º de la 7276 Balca.º, E.º de la (girona) http://www.nargesa.com </small>	

Este plano es propiedad de Fransa Nargesa S.L. No podrá ser reproducido, comunicado a terceros o utilizado para otro fin que no sea el acordado sin su permiso escrito.





N° ORDEN	DIBUJO	DESCRIPCION	N° PLANO	CANTIDAD
2.02.01		RODILLO ENDEREZADOR	120-11-01-00320	2
2.02.02		CASQUILLO RETEN RODILLO ENDEREZADOR	120-11-01-00389	4
2.02.03		RODAMIENTO DOBLE 4204ATN9 D20XD47X18	030-CJ-00026	4
2.02.04		RETEN D30XD47X7	040-RET-00010	4

A6. Upper straightener assembly

130-11-01-00305	N° Despiece		PLANO DE ENSAMBLAJE Conjunto Enderezador Superior	Ref. del ensamblaje 130-11-01-00305	Dibujado Verificado	Nombre tecnico20	Fecha 27/05/2015	
				Tratamiento N/D	Maq. 100-11-01-002 NOA60			

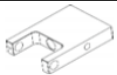







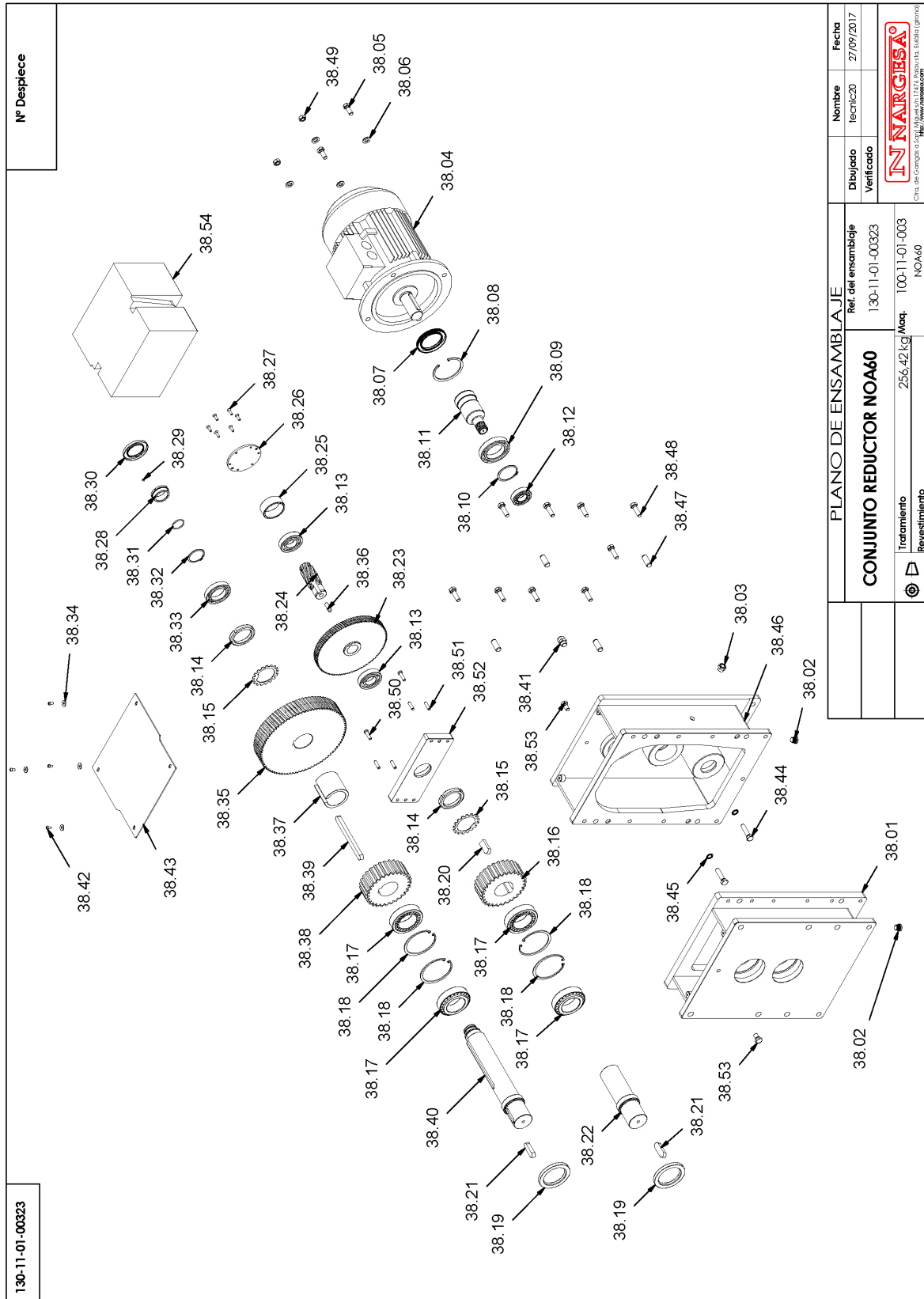











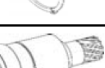

Ctra. de Comigós a Soria, km. 17,276 Pol. Ind. Eulalia (girona)
 17100 NARGESA (Girona)
 Este plano es propiedad de Fransa Nargesa S.L. No podrá ser reproducido, comunicado a terceros o utilizado para otro fin que no sea el acordado sin su permiso escrito.

N° ORDEN	DIBUJO	DESCRIPCION	N° PLANO	CANTIDAD
7.01		SOPORTE RODILLO ENDEREZADOR SUPERIOR	120-11-01-00319	1
7.02		EJE RODILLO ENDEREZADOR	120-11-01-00348	1
7.03		ESPARRAGO ALLEN DIN 913 M6X8	020-D913-M6X8	1
7.04		RODILLO ENDEREZADOR MOVIL	130-11-01-00304	1

A7. Gearbox assembly



Nº ORDEN	DIBUJO	DESCRIPCION	Nº PLANO	CANTIDAD
38.01		CARCASA REDUCTOR LADO MAQUINA	130-11-01-00321	1
38.02		TAPON DE VACIADO ALLEN 3/8" GAS	040-TVA-00004	2
38.03		NIVEL DE ACEITE 3/8"	040-NA-00001	1
38.04		MOTOR ELECTRICO DE 5.5 KW A 1400 RPM BRIDA B5	050-ME-00010	1
38.05		TORNILLO HEXAGONAL DIN 933 M12X30	020-D933-M12X30	2
38.06		ARANDELA DIN 125 B M12	020-D125B-M12	4
38.07		RETEN D65XD95X10	040-RET-00006	1
38.08		CIRCLIP AGUJERO DIN472 D95X3	030-D472-00013	1
38.09		COJINETE DE BOLAS 6012 D60XD95X18	030-CJ-00010	1
38.10		CIRCLIP EJE DIN471 D60	030-D471-00012	1
38.11		PIÑÓN ENTRADA MOTOR	120-12-02-00017	1
38.12		COJINETE DE RODILLOS NJ206 D30XD62X16	030-CJ-00017	1
38.13		COJINETE DE BOLAS 6207 D35XD72X17	030-CJ-00013	2
38.14		TUERCA RANURADA DIN 981 M60X2 KM12	020-D981-KM12	2
38.15		ARANDELA FIJACIÓN TUERCA KM-12 EJE INFERIOR	120-12-02-00191	2
38.16		ENGRANAJE INFERIOR REENVIO	120-12-02-00113	1
38.17		COJINETE RODILLOS CONICOS 33112 60X100X30	030-CJ-00006	4
38.18		CIRCLIP AGUJERO DIN472 D100X3	030-D472-00011	4
38.19		RETEN D70XD100X10	040-RET-00007	2
38.20		CHAVETA DIN 6885 AB 18X11X47	030-D6885AB-00006	1

Nº ORDEN	DIBUJO	DESCRIPCION	Nº PLANO	CANTIDAD
38.21		CHAVETA PARALELA DIN6885A 18X11X56	030-D6885A-00028	2
38.22		EJE MOTRIZ INFERIOR	120-11-01-00401	1
38.23		ENGRANAJE 1	120-12-02-00109	1
38.24		PIÑON 2	120-12-02-00110	1
38.25		SEPARADOR COJINETE	120-12-02-00136	1
38.26		TAPETA COJINETE INFERIOR	120-12-02-00134	1
38.27		TORNILLO ALLEN DIN 7991 M6X20	020-D7991-M6X20	6
38.28		ANILLO TRASERO CAJA MAQUINA GRABAR	120-11-01-00376	1
38.29		ESPARRAGO ALLEN DIN 913 M5X6	020-D913-M5X6	1
38.30		RETEN D50XD80X8	040-RET-00002	1
38.31		JUNTA TORICA D34X3 90 SHORE	040-JT-00029	1
38.32		CIRCLIP EJE DIN471 D50	030-D471-00011	1
38.33		COJINETE DE BOLAS 6010 D50XD80X16	030-CJ-00009	1
38.34		ARANDELA DIN 9021 M6	020-D9021-M6	4
38.35		ENGRANAJE 2	120-12-02-00111	1
38.36		CHAVETA DIN6885 A 10X8X32	030-D6885A-00024	1
38.37		CASQUILLO SEPARADOR 2	120-12-02-00135	1
38.38		ENGRANAJE SUPERIOR REENVIO	120-12-02-00112	1
38.39		CHAVETA DIN 6885 A 18X11X180	030-D6885A-00025	1
38.40		EJE MOTRIZ SUPERIOR	120-11-01-00400	1

Nº ORDEN	DIBUJO	DESCRIPCION	Nº PLANO	CANTIDAD
38.41		TAPON RESPIRADERO 3/8"	040-TRE-00001	1
38.42		TORNILLO ISO 7380 M6X12	020-I7380-M6X12	4
38.43		TAPA REDUCTOR	120-11-01-00416	1
38.44		TORNILLO HEXAGONAL DIN 933 M12X50	020-D933-M12X50	2
38.45		JUNTA METAL GOMA 1/4"	040-JMG-00002	2
38.46		CARCASA REDUCTOR LADO MOTOR	130-11-01-00322	1
38.47		PASADOR CILINDRICO CON ROSCA INT. DIN7979/D D16X40	030-D7979D-00020	4
38.48		TORNILLO HEXAGONAL DIN 933 M12X40	020-D933-M12X40	9
38.49		TUERCA DIN 934 M12	020-D934-M12	2
38.50		TORNILLO ALLEN CABEZA REDUCIDA DIN 6912 M8X30	020-D6912-M8X30	2
38.51		PASADOR CILINDRICO DIN 7979D D8X30	030-D7979D-00004	4
38.52		SOPORTE CENTRAL REDUCTOR	120-11-01-00415	1
38.53		TORNILLO HEXAGONAL DIN 933 M12X20	020-D933-M12X20	2
38.54		VALVULINA SAE 80-140		15

A8. Electrical diagrams

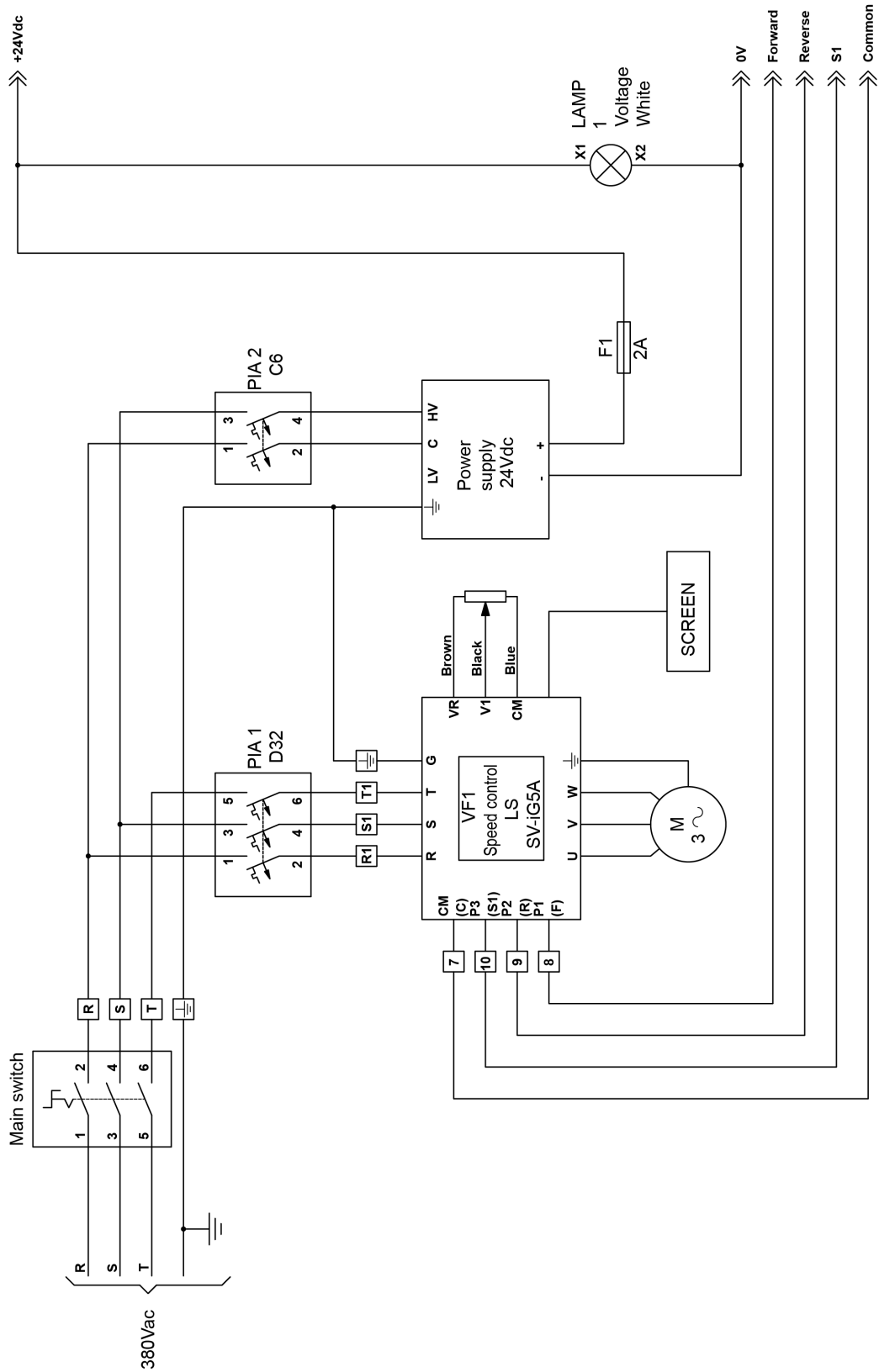

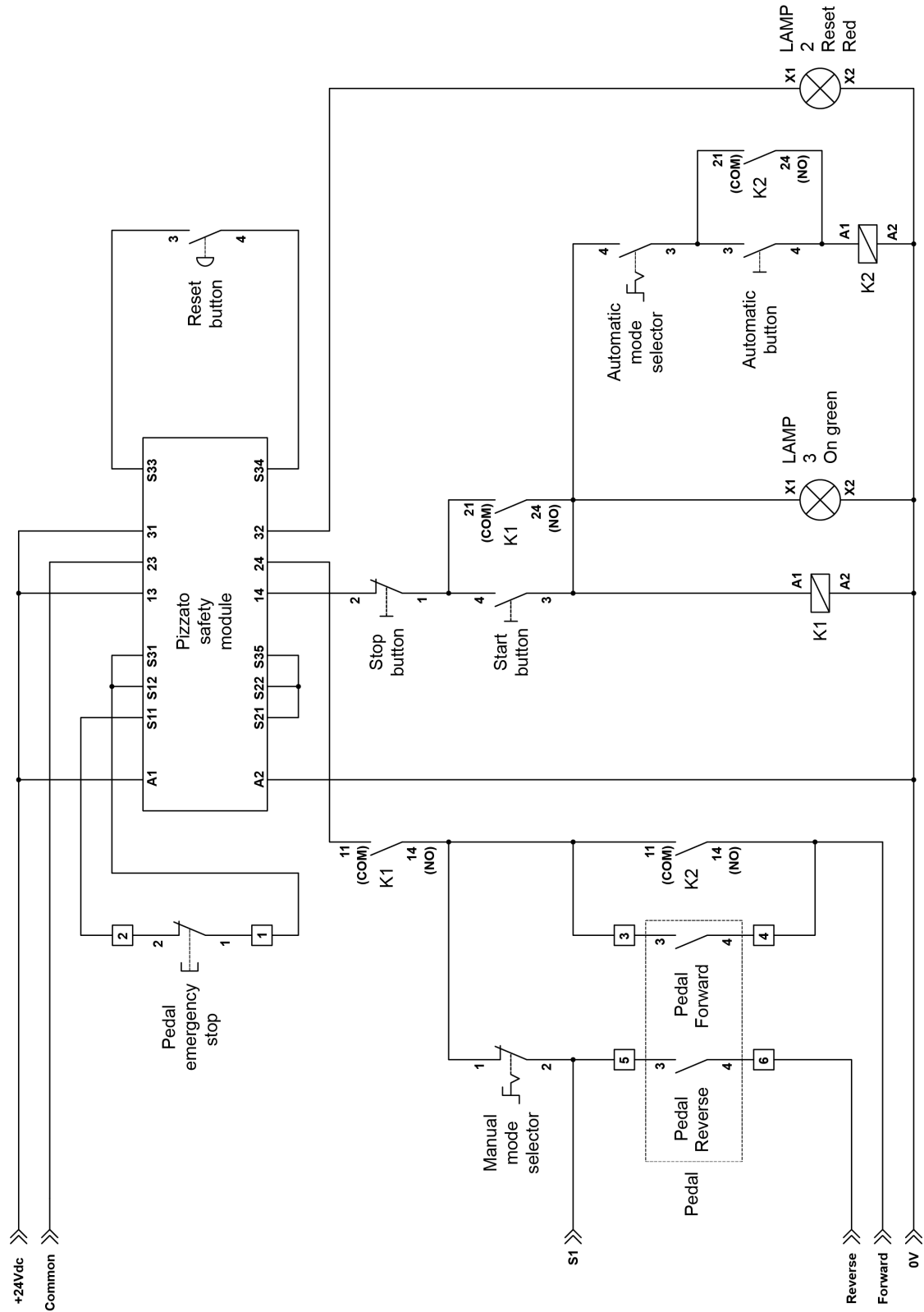

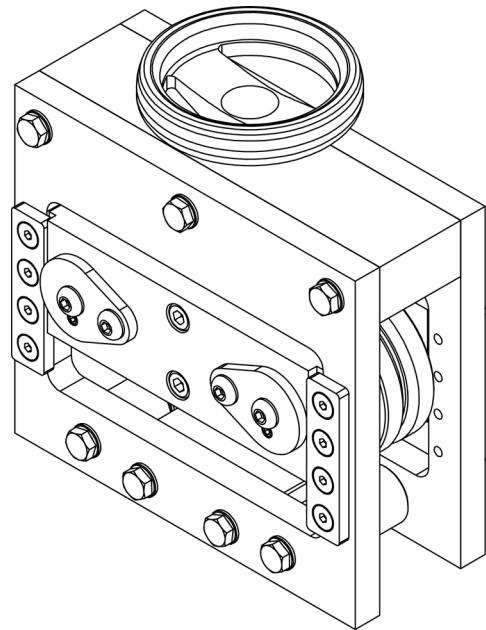

Technical features of accessories

Inlet guide for edge square bar

Ref: 140-11-01-00027

- Description of tooling
- Identification of elements
- Setting up the tooling
- Performance
- Warnings
- List of parts

Identification of elements

The inlet guide to emboss solid square bar on the edge up to 20 mm or 3/4" inches is supplied completely assembled with all necessary bolts to fix it to the machine..

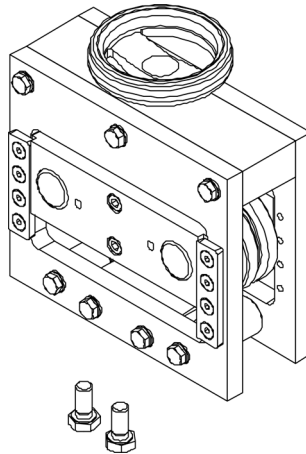

Setting up the tooling

In order to fix the tooling to the embossing machine NOA60, it is required to adjust it by fastening the bolts at the inlet guide of the machine as indicated in the pictures below:

1. Insert the tooling in the inlet guide of the machine

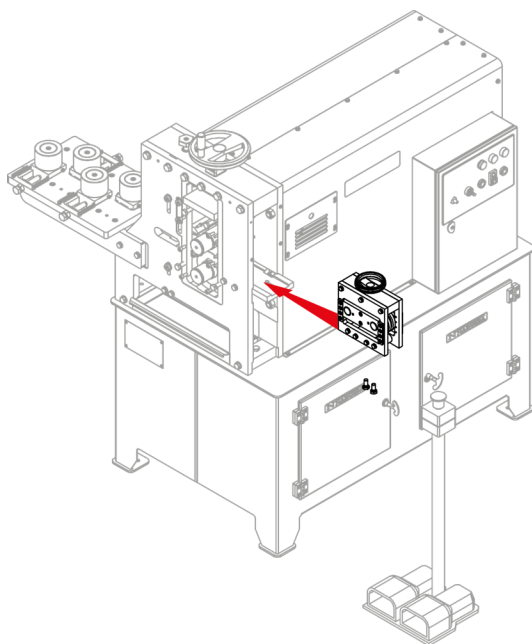

2. fasten both fixing bolts to the tooling by the lower part of the inlet guide of the machine.

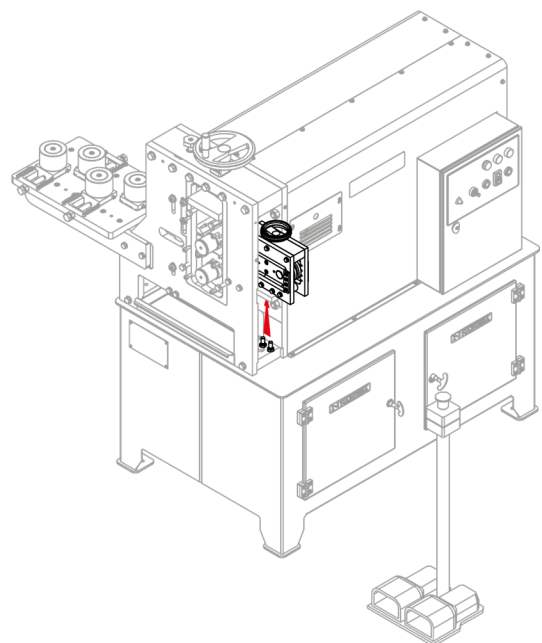

Performance

In order to start working with the inlet guide to emboss solid square bar on the edge, it is required to adjust the upper rollers to the material. Turning clockwise around the upper Wheel of the tooling, these upper rollers will move upwards. By turning the upper Wheel anti-clockwise, the upper rollers will go downwards.

We should make sure the material is properly fixed and that it keeps its position

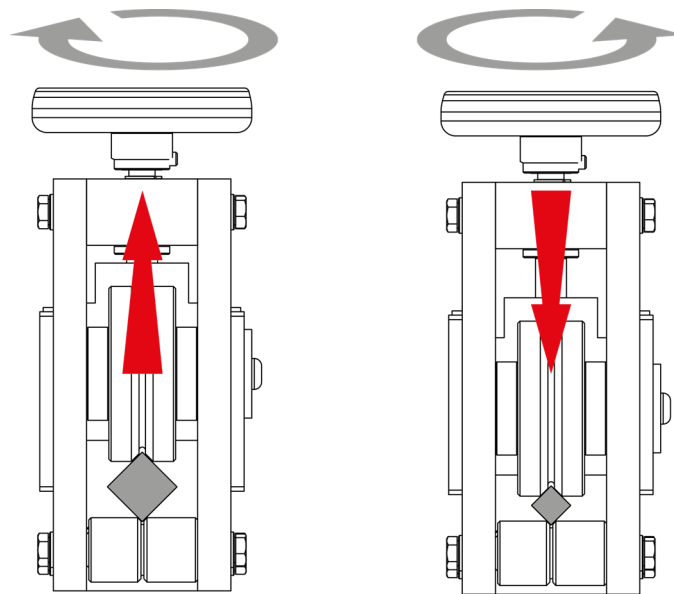

Warnings

Keep the following instructions to safely use the Inlet guide for square bar on the edge.:

- Do not set or remove the tooling while the machine is running.
- Do not use the tooling for any other purpose but the ones described on this handling booklet.
- Use protection gloves to manipulate components and during the working process
- Use homologated protection goggles and shoes.
- Hold the base material.

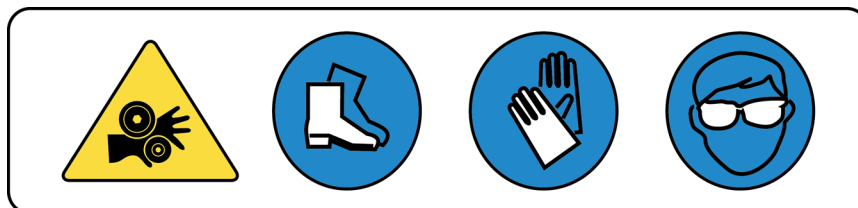

List of parts

140-11-01-00027

Nº Despiece

PLANO DE ENSAMBLAJE		Nombre	Fecha
UTIL ENTRADA CUADRADO AL CANTO		Techic20	19/05/2016
Ref. del ensamblaje		Dibujado	Verificado
140-11-01-00027			
Moaq.		N/D	NOA60
Tratamiento			
Revestimiento			

Che. el control de Calidad. Material: 140-11-01-00027. Estruct. (página 4)
 Este plano es propiedad de Fransa Nargesa S.L. No podrá ser reproducido, comunicado o alterado sin el consentimiento por su propietario.

1	125-11-01-00031	RODILLO GUIA ENTRADA CUADRADO DIAGONAL	2
2	125-11-01-00032	GUIA MOVIL 2	2
3	125-11-01-00033	SOPORTE CENTRAL RODILLOS ENTRADA	1
4	125-11-01-00034	PLACA SUPERIOR ENTRADA CUADRADO	1
5	020-D912-M8X20	TORNILLO ALLEN DIN 912 M8X20	4
6	020-D933-M8X25	TORNILLO HEXAGONAL DIN 933 M8X25	14
7	125-11-01-00035	ARANDELA BRONCE	1
8	125-11-01-00036	ARANDELA LATERAL BRONCE RODILLOS ENTRADAS	4
9	030-DP-00013	DOLLA PARTIDA D30XD34X30	2
11	030-D471-00002	CIRCLIP EJE DIN 471 Ø12x1	1
12	125-11-01-00040	ANCLAJE RODILLOS ENTRADA	1
13	125-11-01-00030	PLACA LATERAL GUIA ENTRADA	2
14	125-11-01-00041	RODILLO INFERIOR ENTRADA	2
15	030-DP-16X22X20	Casquillo partido D16XD22X20	4
16	125-11-01-00042	EJE RODILLO INFERIOR	2
17	125-11-01-00043	GUIA LATERAL	4
21	125-11-01-00037	EJE REGULACION RODILLOS	1
28	020-D7991-M6X12	TORNILLO ALLEN DIN 7991 M6x12	16
29	020-D125B-M8	Arandela DIN 125-B M8 Zincada	14
30	031-VOL-00005	VOLANTE D100 AGUJERO D12	1
31	020-D914-M6X10	ESPIGA ALLEN DE PUNTA DIN 914 M6X10	1
32	125-11-01-00053	BULON SUPERIOR RODILLOS ENTRADA	2
33	125-11-01-00052	OREJA FIJACION BULONES RODILLOS ENTRADA	2
34	020-D7380-M8X20	TORNILLO ALLEN CABELA REDONDA ISO 7380 M8X20 PAVONADO	4
35	020-D913-M6X16	ESPARRAGO ALLEN DIN 913 M6x16	2

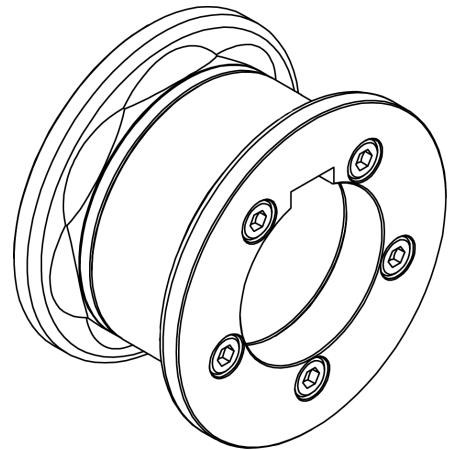

Technical features of accessories

Roller for the side marking of flat bar

25mm or 1", 30mm or 1" 1/4, 40mm or 1" 1/2 and 50mm or 2"

Ref. 140-11-01-00028

Elements identification

Roller assembling

Roller assembling for 25mm or 1" handrail

Roller assembling for 30mm or 1" 1/4 handrail

Roller assembling for 40mm or 1" 1/2 handrail

Roller assembling for 50mm or 2" handrail

Elements identification

Sectioned rollers for handrail embossing have been designed to work on different handrail sizes with one only set of rollers.

IMPORTANT: In order to achieve a correct use of the machine, it is remarkably essential to place all elements so the total length of the set always remains 80mm.



HAZARD: Never surpass 80mm as maximum length

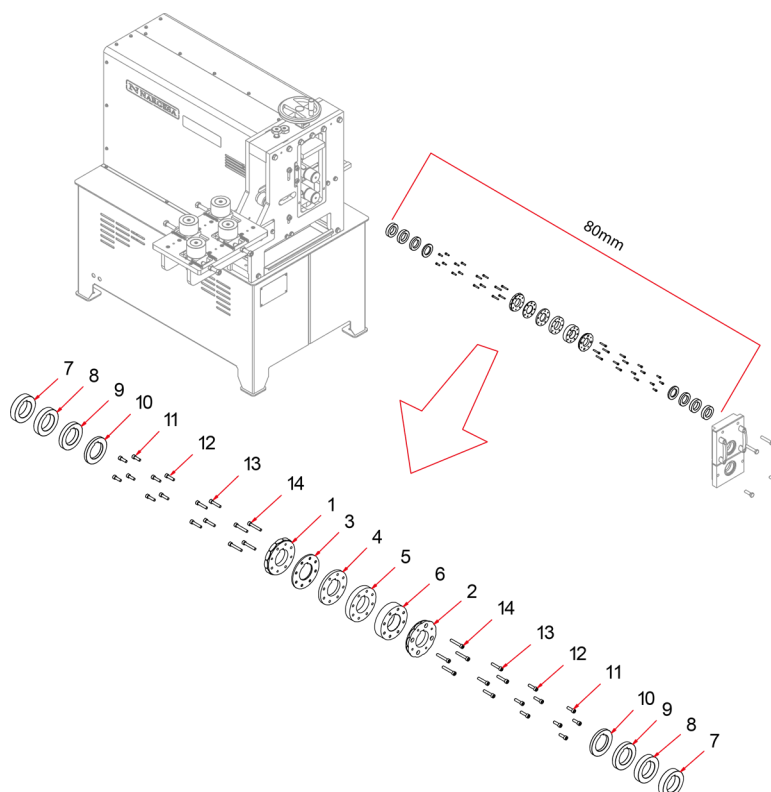

1	125-11-01-00054	LATERAL INNER ROLLER	1
2	125-11-01-00055	LATERAL OUTER ROLLER	1
3	125-11-01-00056	SECTIONED HANDRAIL SPACER 25-1"	1
4	125-11-01-00058	SECTIONED HANDRAIL SPACER 30-1"-1/4	1
5	125-11-01-00060	SECTIONED HANDRAIL SPACER 40-1"-1/2	1
6	125-11-01-00062	SECTIONED HANDRAIL SPACER 50-2"	1
7	125-11-01-00057	SPACER 22.5mm	2
8	125-11-01-00059	SPACER 20mm	2
9	125-11-01-00061	SPACER 15mm	2
10	125-11-01-00063	SPACER 10 mm	2
11	020-D912-M8X25	ALLEN SCREW DIN 912 M8 x25	8
12	020-D912-M8X30	ALLEN SCREW DIN 912 M8X30	8
13	020-D912-M8X40	ALLEN SCREW DIN 912 M8X40	8
14	020-D912-M8X50	ALLEN SCREW DIN 912 M8X50	8

Rollers assembling

We'll use the different rollers sections depending on the size of the handrail to be embossed.

Then we'll detail every element used for each handrail size, always including sections 1 and 2 to these sets, which are the ones to perform the embossing operation as such.

Rollers assembling for 25mm or 1" handrail

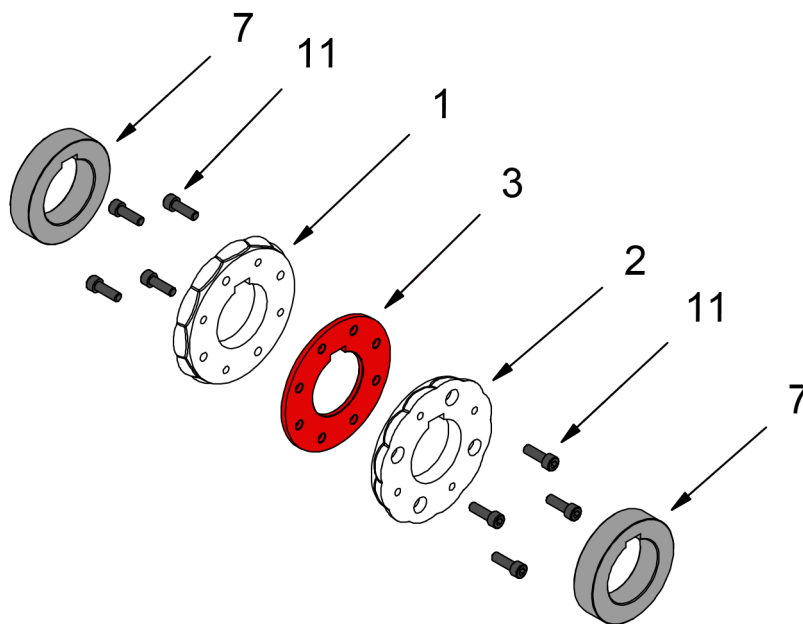

	INTERIOR	3	125-11-01-00056	SECTIONED HANDRAIL SPACER 25-1"
	EXTERIOR	7	125-11-01-00057	SPACER 22.5mm
	TORNILLOS	11	020-D912-M8X25	ALLEN SCREW DIN 912 M8 x25
		1	125-11-01-00054	LATERAL INNER ROLLER
		2	125-11-01-00055	LATERAL OUTER ROLLER

We will use the different sections of the rollers depending on the handrail size that we are going to emboss.
To assemble the **roller of 25mm or 1"** we will proceed as follows:

1. We put into order the different sections

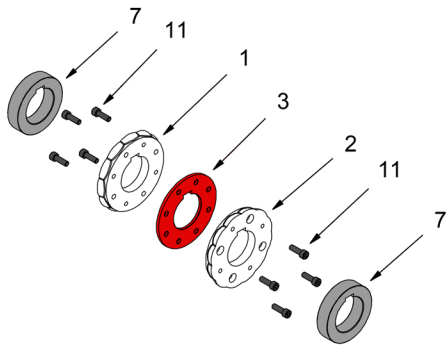

2. We do a pre-assembly, without tightening the bolts, paying special attention in aligning the slots for the pin.

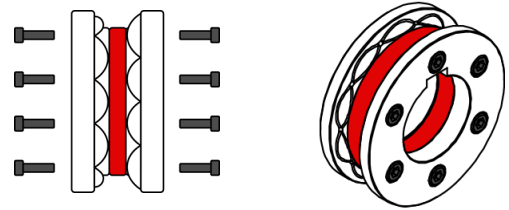

3. Next we place the outer spacer 7 on the upper machine shaft.

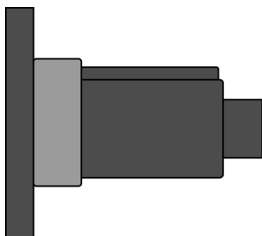

4. Place the pre-mounted roller on the upper axis and tighten the bolts with the Allen key.

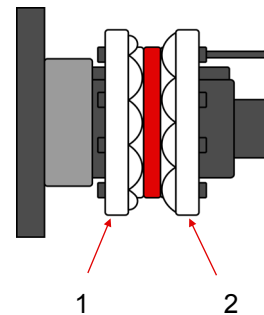

5. We remove the roller from the shaft and we rotate it so that the front part is positioned behind and then we put it in again.

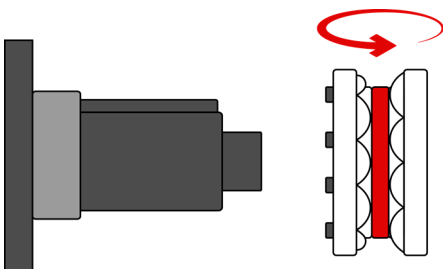

6. Tighten the bolts with the Allen key.

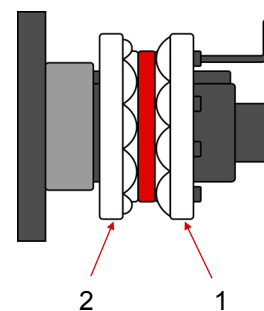

7. We remove the roller from the shaft and we rotate it so that the front part is positioned behind and then we put it in again.

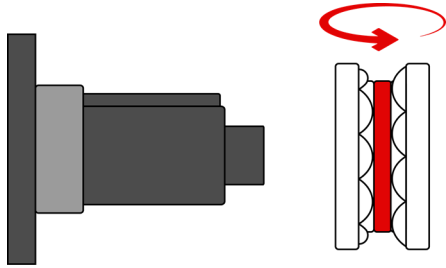

8. Next we place the outer spacer 7 on the upper machine shaft.

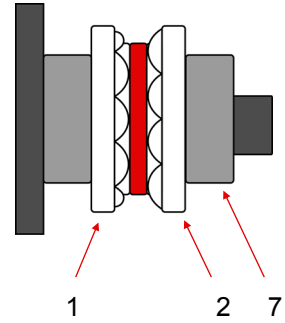

9. Close the roller compartment with the outer cover.

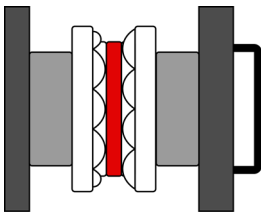

We will use the different sections of the rollers depending on the handrail size that we are going to emboss. To assemble the **roller of 30mm or 1" 1/4** we will proceed as follows:

1. We put into order the different sections

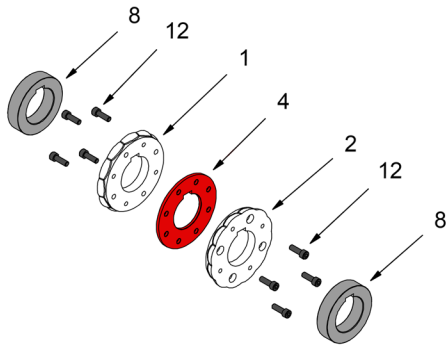

2. We do a pre-assembly, without tightening the bolts, paying special attention in aligning the slots for the pin.

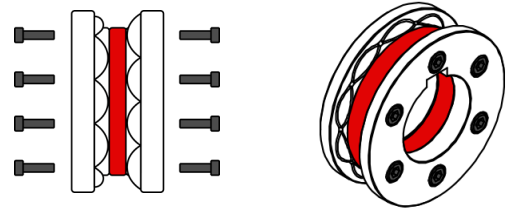

3. Next we place the outer spacer 8 on the upper machine shaft.

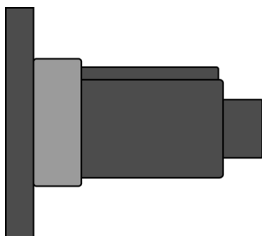

4. Place the pre-mounted roller on the upper axis and tighten the bolts with the Allen key.

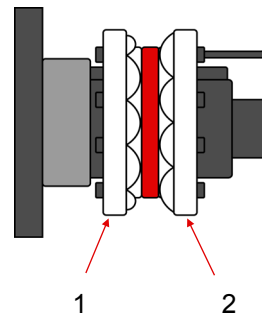

5. We remove the roller from the shaft and we rotate it so that the front part is positioned behind and then we put it in again.

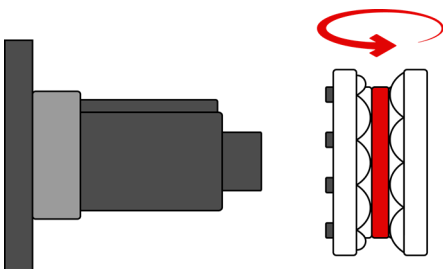

6. Tighten the bolts with the Allen key.

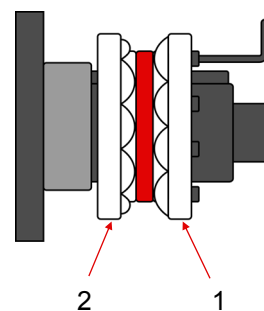

7. We remove the roller from the shaft and we rotate it so that the front part is positioned behind and then we put it in again.

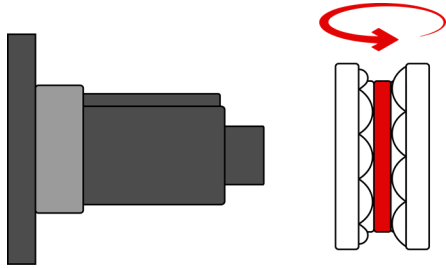

8. Next we place the outer spacer 8 on the upper machine shaft.

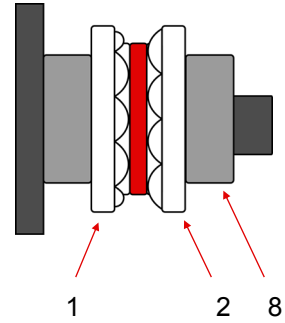

9. Close the roller compartment with the outer cover.

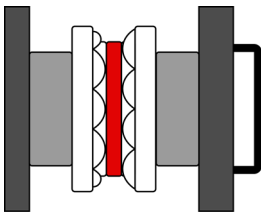

Rollers assembling for 40mm o 1" 1/2 handrail

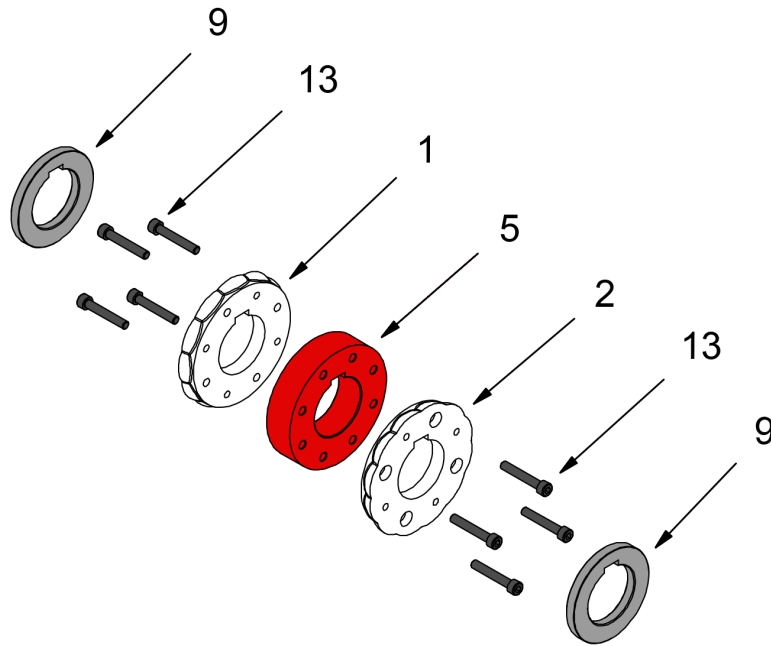

	INTERIOR	5	125-11-01-00060	SECTIONED HANDRAIL SPACER 40-1"-1/2
	EXTERIOR	9	125-11-01-00061	SPACER 15mm
	TORNILLOS	13	020-D912-M8X40	ALLEN SCREW DIN 912 M8X40
		1	125-11-01-00054	LATERAL INNER ROLLER
		2	125-11-01-00055	LATERAL OUTER ROLLER

We will use the different sections of the rollers depending on the handrail size that we are going to emboss. To assemble the **roller of 40mm or 1" 1/2** we will proceed as follows:

1. We put into order the different sections

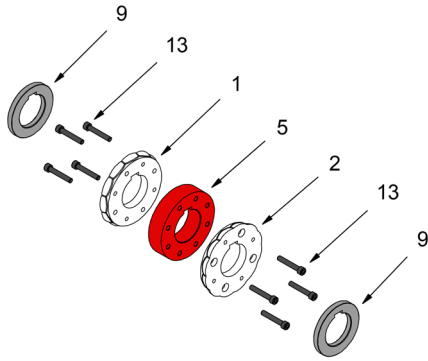

2. We do a pre-assembly, without tightening the bolts, paying special attention in aligning the slots for the pin.

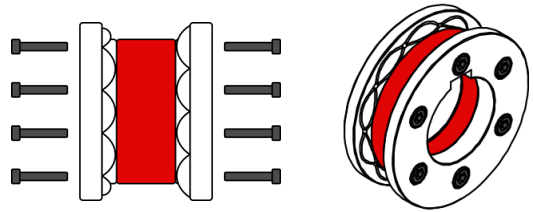

3. Next we place the outer spacer 9 on the upper machine shaft.

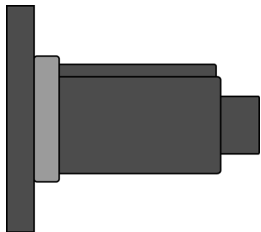

4. Place the pre-mounted roller on the upper axis and tighten the bolts with the Allen key.

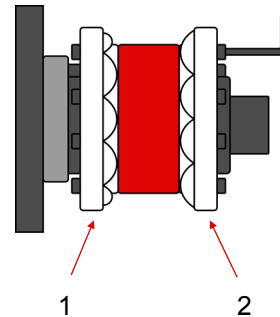

5. We remove the roller from the shaft and we rotate it so that the front part is positioned behind and then we put it in again.

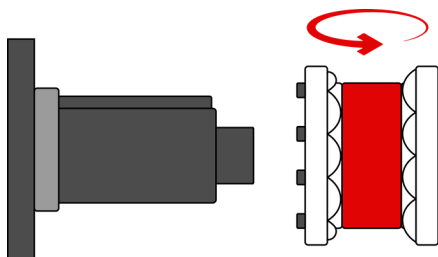

6. Tighten the bolts with the Allen key.

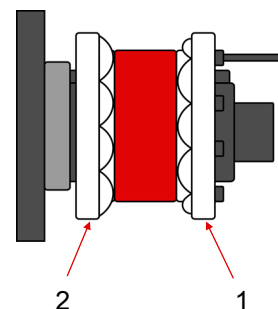

7. We remove the roller from the shaft and we rotate it so that the front part is positioned behind and then we put it in again.

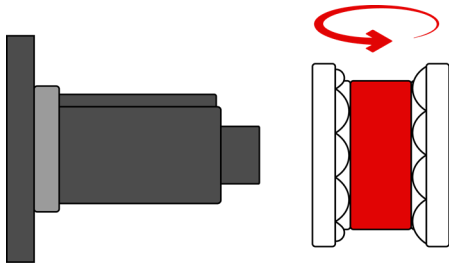

8. Next we place the outer spacer 9 on the upper machine shaft.

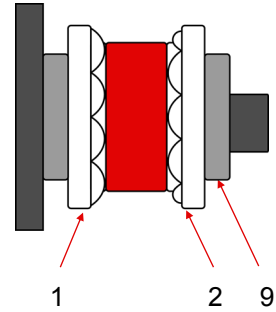

9. Close the roller compartment with the outer cover.

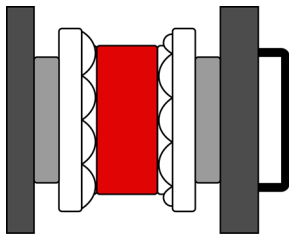

Rollers assembling for 50mm o 2" handrail

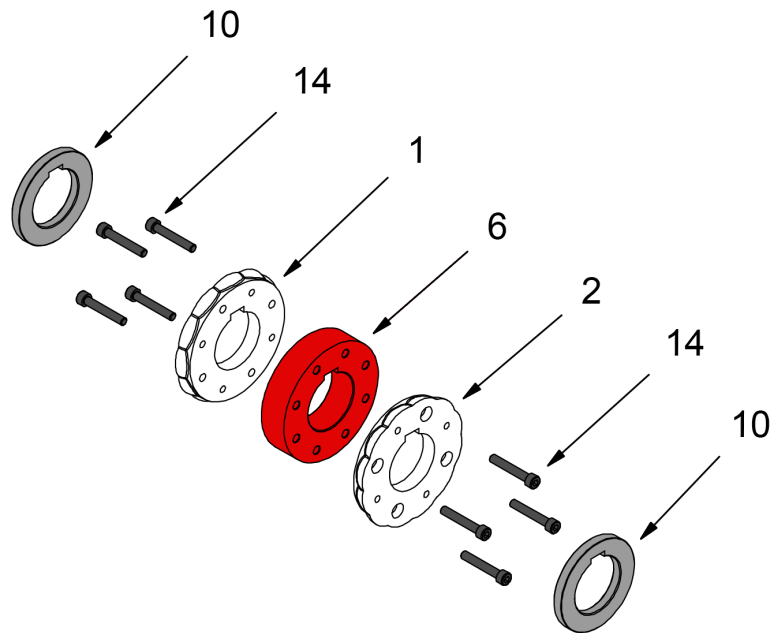

	INTERIOR	6	125-11-01-00062	SECTIONED HANDRAIL SPACER 50-2"
	EXTERIOR	10	125-11-01-00063	SPACER 10 mm
	TORNILLOS	14	020-D912-M8X50	ALLEN SCREW DIN 912 M8X50
		1	125-11-01-00054	LATERAL INNER ROLLER
		2	125-11-01-00055	LATERAL OUTER ROLLER

We will use the different sections of the rollers depending on the handrail size that we are going to emboss. To assemble the **roller of 50mm or 2"** we will proceed as follows:

1. We put into order the different sections

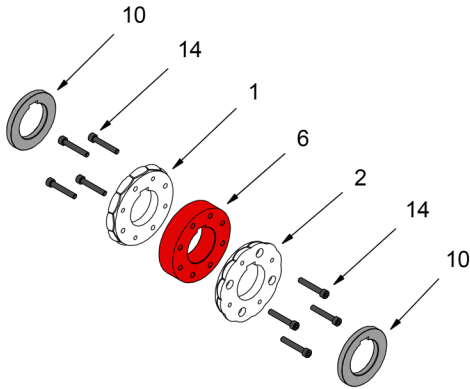

2. We do a pre-assembly, without tightening the bolts, paying special attention in aligning the slots for the pin.

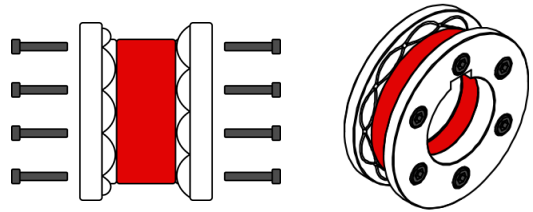

3. Next we place the outer spacer 10 on the upper machine shaft.

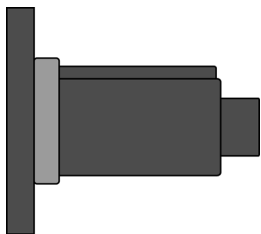

4. Place the pre-mounted roller on the upper axis and tighten the bolts with the Allen key.

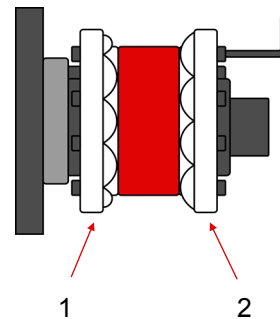

5. We remove the roller from the shaft and we rotate it so that the front part is positioned behind and then we put it in again.

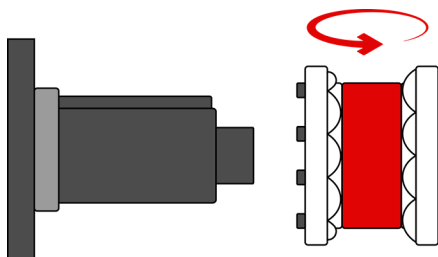

6. Tighten the bolts with the Allen key.

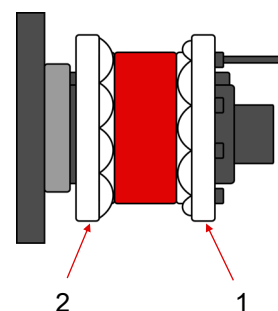

7. We remove the roller from the shaft and we rotate it so that the front part is positioned behind and then we put it in again.

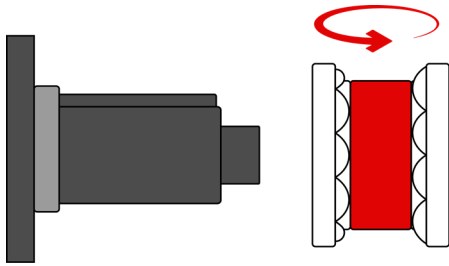

8. Next we place the outer spacer 10 on the upper machine shaft.

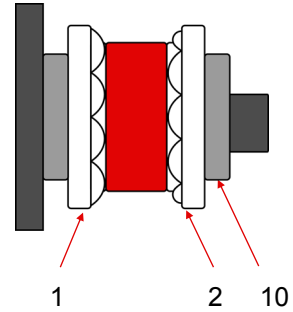

9. Close the roller compartment with the outer cover.

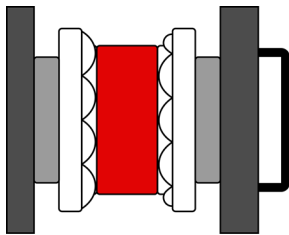

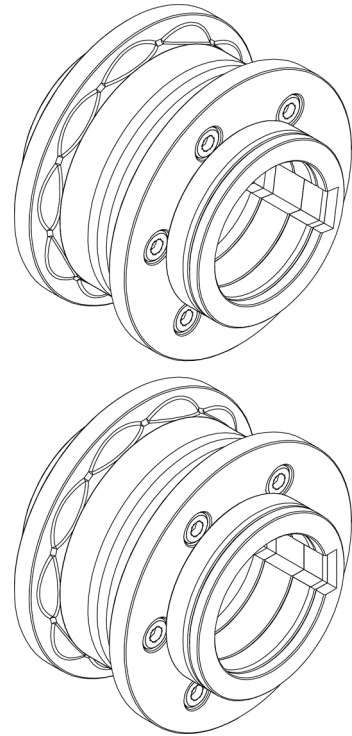

Technical features of accessories

**Set of embossing rollers for 25 mm or 1"
30 mm or 1" 1/4, 35 and 40 mm pipes**

Ref. 140-11-01-00500

Elements identification

Upper roller

Lower Roller

Rollers assembling

Rollers assembling for 25mm or 1" pipe

Rollers assembling for 30mm or 1" 1/4 pipe

Rollers assembling for 35mm pipe

Rollers assembling for 40mm pipe

Our range of rollers for pipe embossing

Elements identification

Sectioned rollers for pipe embossing have been designed to work on different pipe sizes with one only set of rollers.

Upper roller

IMPORTANT: In order to achieve a correct use of the machine, it is remarkably essential to place all elements so the total length of the set always remains 80mm.



HAZARD: Never surpass 80mm as maximum length

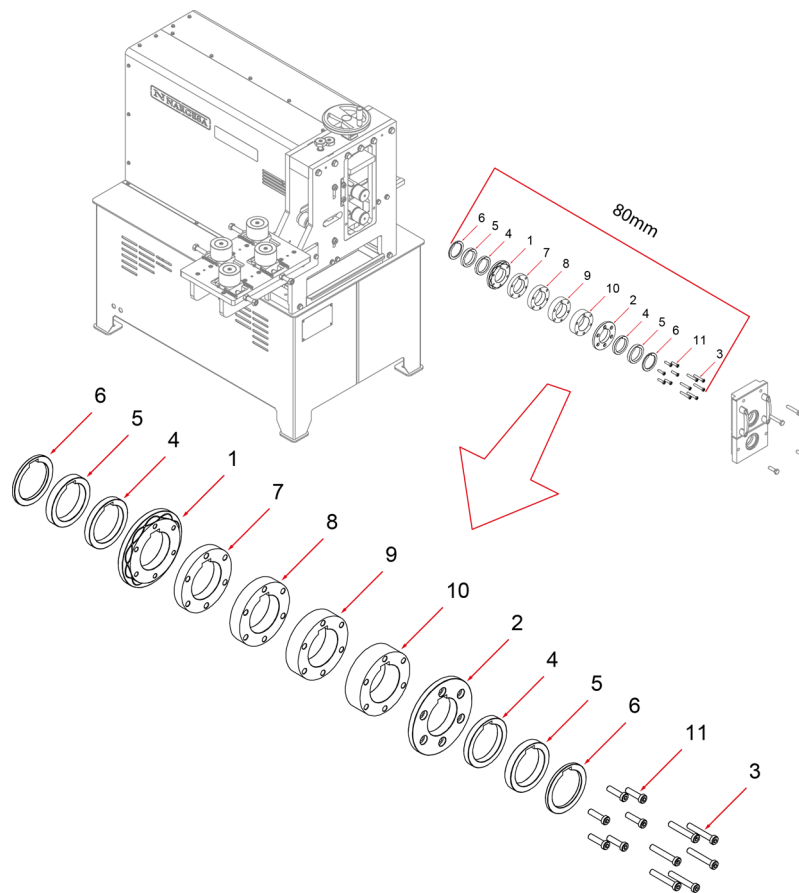

1	125-11-01-00005	LATERAL UPPER INNER ROLLER PIPE 25-40	1
2	125-11-01-00006	LATERAL UPPER OUTER ROLLER PIPE 25-40	1
3	020-D6912-M8X50	ALLEN SMALL HEADED SCREW DIN 6912 M8X50	6
4	125-11-01-00011	10 mm SECTIONED PIPE SPACER 25-40	2
5	125-11-01-00012	12.5 mm SECTIONED PIPE SPACER 25-40	2
6	125-11-01-00013	5 mm SECTIONED PIPE SPACER 25-40	2
7	125-11-01-00008	15 mm SECTIONED SPACER ROLLER 25	1
8	125-11-01-00009	20 mm SECTIONED SPACER ROLLER 30	1
9	125-11-01-00010	25 mm SECTIONED SPACER ROLLER 35	1
10	125-11-01-00007	28.5 mm SECTIONED SPACER ROLLER 40	1
11	020-D6912-M8X30	ALLEN SMALL HEADED SCREW DIN 6912 M8X30	6

Lower roller

IMPORTANT: In order to achieve a correct use of the machine, it is remarkably essential to place all elements so the total length of the set always remains 80mm.



HAZARD: Never surpass 80mm as maximum length

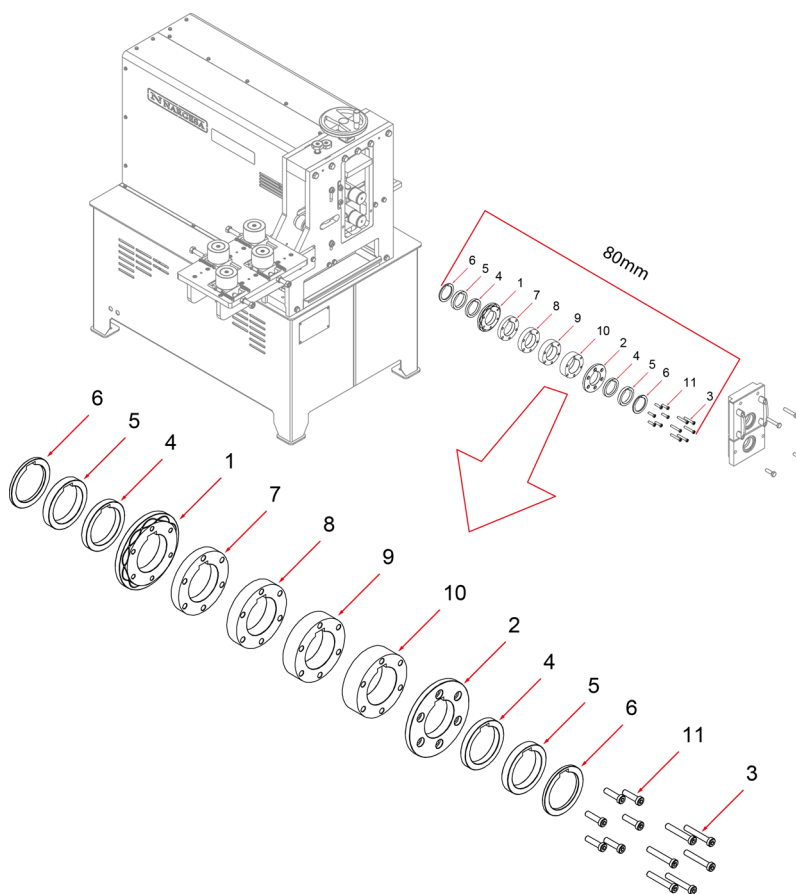

1	125-11-01-00005	LATERAL LOWER INNER ROLLER PIPE 25-40	1
2	125-11-01-00006	LATERAL LOWER OUTER ROLLER PIPE 25-40	1
3	020-D6912-M8X50	ALLEN SMALL HEADED SCREW DIN 6912 M8X50	6
4	125-11-01-00011	10 mm SECTIONED PIPE SPACER 25-40	2
5	125-11-01-00012	12.5 mm SECTIONED PIPE SPACER 25-40	2
6	125-11-01-00013	5 mm SECTIONED PIPE SPACER 25-40	2
7	125-11-01-00008	15 mm SECTIONED SPACER ROLLER 25	1
8	125-11-01-00009	20 mm SECTIONED SPACER ROLLER 30	1
9	125-11-01-00010	25 mm SECTIONED SPACER ROLLER 35	1
10	125-11-01-00007	28.5 mm SECTIONED SPACER ROLLER 40	1
11	020-D6912-M8X30	ALLEN SMALL HEADED SCREW DIN 6912 M8X30	6

Rollers assembling

We'll use the different rollers sections depending on the size of the pipe to be embossed.

Then we'll detail every element used for each pipe size, always including sections 1 and 2 to these sets, which are the ones to perform the embossing operation as such.

Rollers assembling for 25mm or 1" pipe

Upper roller

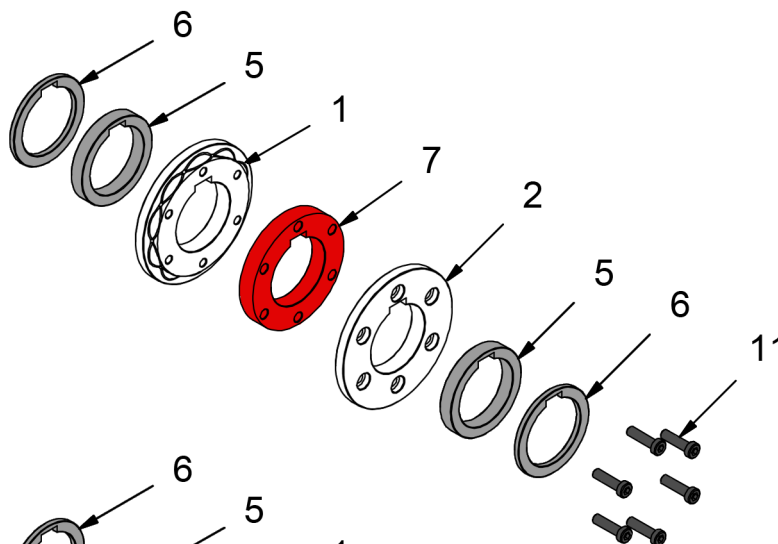

Lower roller

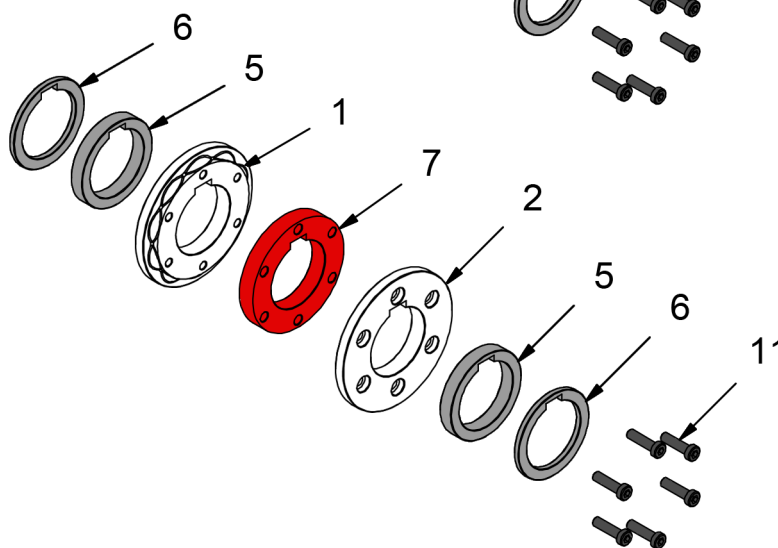

	INSIDE	7	125-11-01-00008	15 mm SECTIONED SPACER ROLLER 25
	EXTERIOR	5	125-11-01-00012	12.5 mm SECTIONED PIPE SPACER 25-40
	EXTERIOR	6	125-11-01-00013	5 mm SECTIONED PIPE SPACER 25-40
	SCREWS	11	020-D6912-M8X30	ALLEN SMALL HEADED SCREW DIN 6912 M8X30
		1	125-11-01-00005	LATERAL INNER ROLLER PIPE 25-40
		2	125-11-01-00006	LATERAL OUTER ROLLER PIPE 25-40

We will use the different sections of the rollers depending on the tube size that we are going to emboss. To assemble the **rolls of 25mm or 1 "** we will proceed as follows:

1. We put into order the different sections

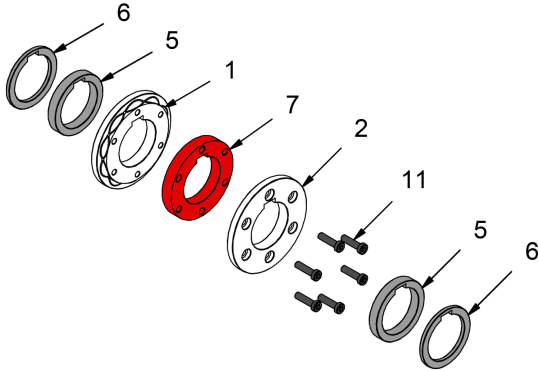

2. We do a pre-assembly, without tightening the bolts, paying special attention in aligning the slots for the pin.

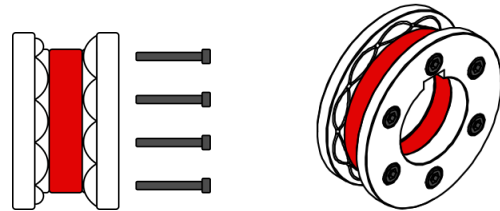

3. Next we place the outer spacers 6 and 5 on the machine shaft.

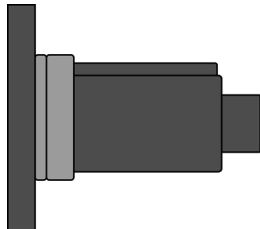

4. Place the pre-mounted roller on the axis of the corresponding machine, top or bottom and tighten the bolts with the Allen key.

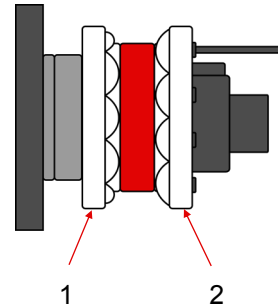

5. Next we place the outer spacers 5 and 6 on the machine shaft.

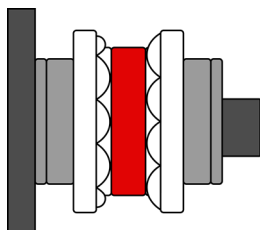

6. Close the roller compartment with the outer cover.

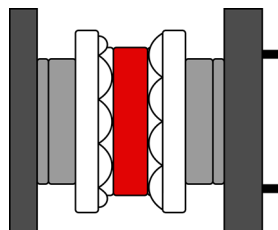

Rollers assembling for 30mm or 1" 1/4 pipe

Upper roller

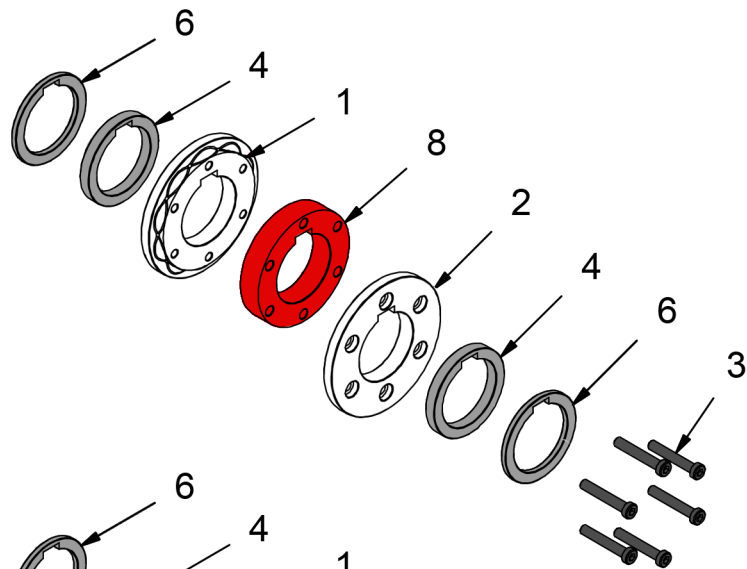

Lower roller

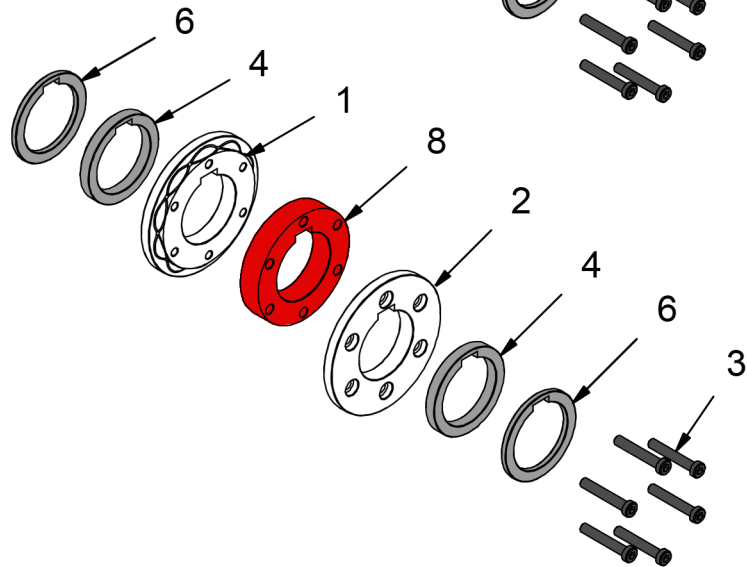

	INSIDE	8	125-11-01-00009	20 mm SECTIONED SPACER ROLLER 30
	EXTERIOR	4	125-11-01-00011	10 mm SECTIONED PIPE SPACER 25-40
	EXTERIOR	6	125-11-01-00013	5 mm SECTIONED PIPE SPACER 25-40
	SCREWS	3	020-D6912-M8X50	ALLEN SMALL HEADED SCREW DIN 6912 M8X50
		1	125-11-01-00005	LATERAL INNER ROLLER PIPE 25-40
		2	125-11-01-00006	LATERAL OUTER ROLLER PIPE 25-40

To assemble the **rolls of 30mm o 1" 1/4** we will proceed as follows:

1. We put into order the different sections

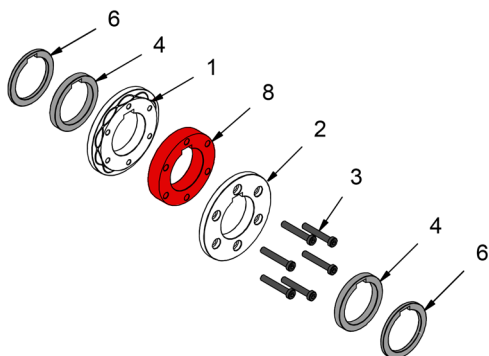

2. We do a pre-assembly, without tightening the bolts, paying special attention in aligning the slots for the pin.

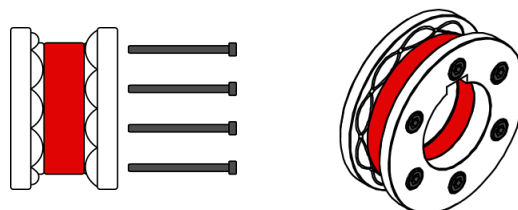

3. Next we place the outer spacers 6 and 4 on the machine shaft.

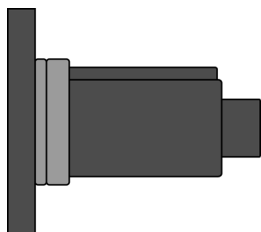

4. Place the pre-mounted roller on the axis of the corresponding machine, top or bottom and tighten the bolts with the Allen key.

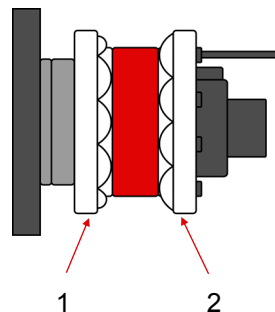

5. Next we place the outer spacers 4 and 6 on the machine shaft.

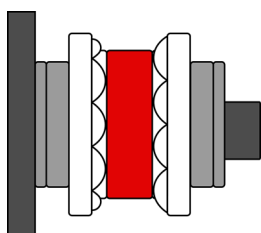

6. Close the roller compartment with the outer cover.

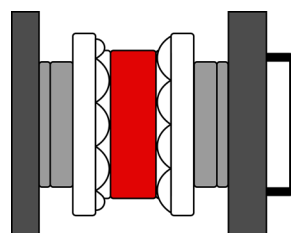

Rollers assembling for 35mm pipe

Upper roller

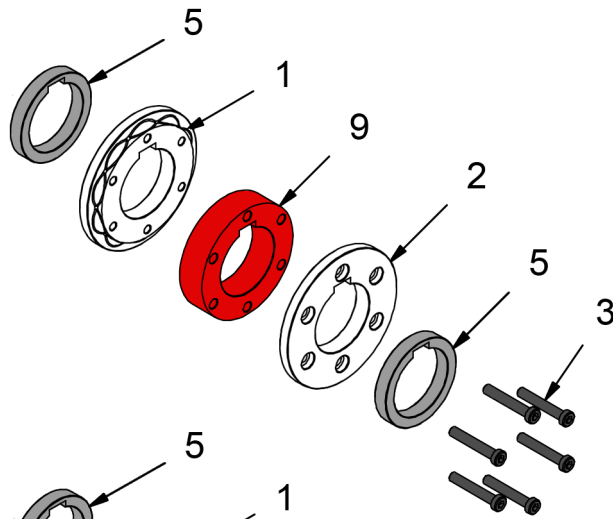

Lower roller

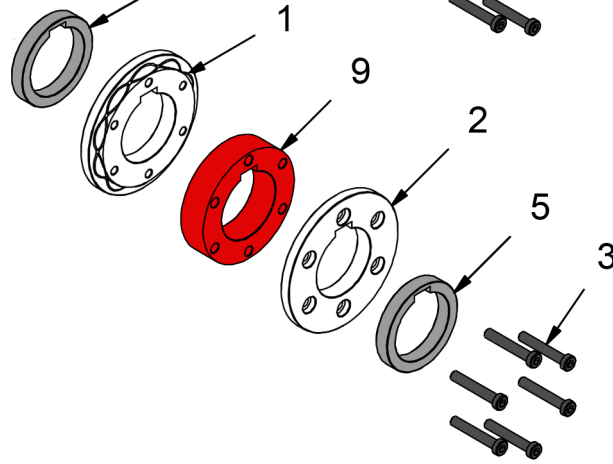

	INSIDE	9	125-11-01-00010	25 mm SECTIONED SPACER ROLLER 35
	EXTERIOR	5	125-11-01-00012	12.5 mm SECTIONED PIPE SPACER 25-40
	SCREWS	3	020-D6912-M8X50	ALLEN SMALL HEADED SCREW DIN 6912 M8X50
		1	125-11-01-00005	LATERAL INNER ROLLER PIPE 25-40
		2	125-11-01-00006	LATERAL OUTER ROLLER PIPE 25-40

To assemble the **rolls of 35mm** we will proceed as follows:

1. We put into order the different sections

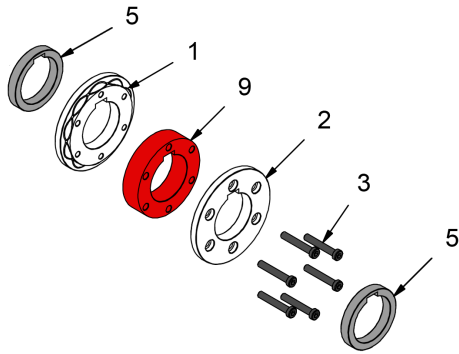

2. We do a pre-assembly, without tightening the bolts, paying special attention in aligning the slots for the pin.

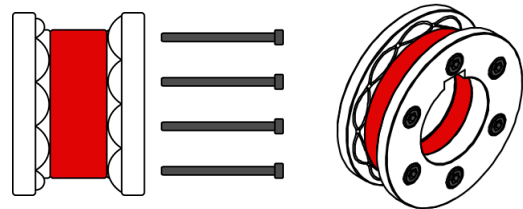

3. Next we place the outer spacer 5 on the machine shaft.

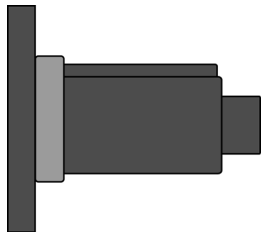

4. Place the pre-mounted roller on the axis of the corresponding machine, top or bottom and tighten the bolts with the Allen key.

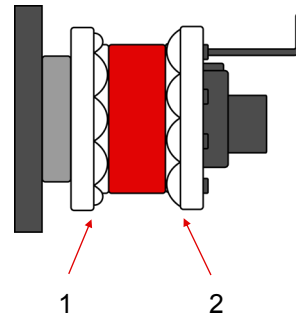

5. Next we place the outer spacer 5 on the machine shaft.

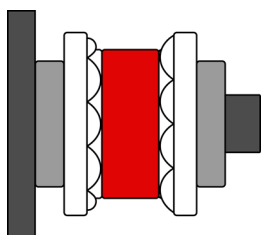

6. Close the roller compartment with the outer cover.

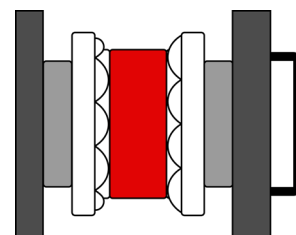

Rollers assembling for 40mm pipe

Upper roller

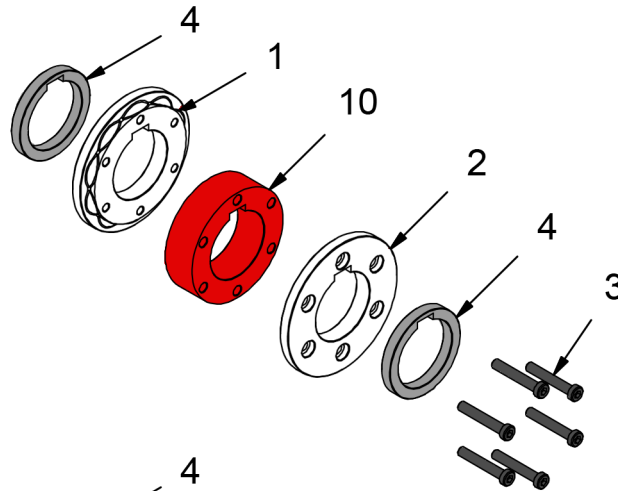

Lower roller

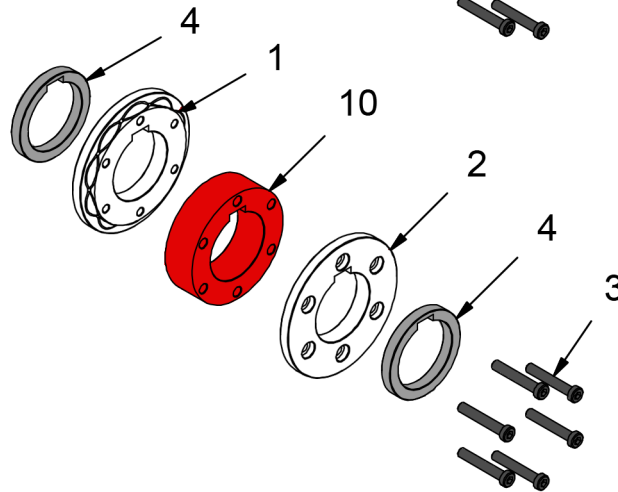

	INSIDE	10	125-11-01-00007	28.5 mm SECTIONED SPACER ROLLER 40
	EXTERIOR	4	125-11-01-00011	10 mm SECTIONED PIPE SPACER 25-40
	SCREWS	3	020-D6912-M8X50	ALLEN SMALL HEADED SCREW DIN 6912 M8X50
		1	125-11-01-00005	LATERAL INNER ROLLER PIPE 25-40
		2	125-11-01-00006	LATERAL OUTER ROLLER PIPE 25-40

To assemble the rolls of 40mm we will proceed as follows:

1. We put into order the different sections

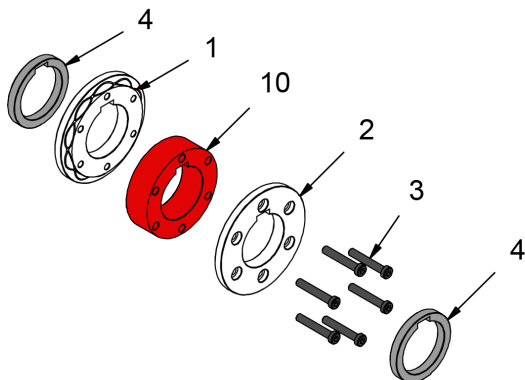

2. We do a pre-assembly, without tightening the bolts, paying special attention in aligning the slots for the pin.

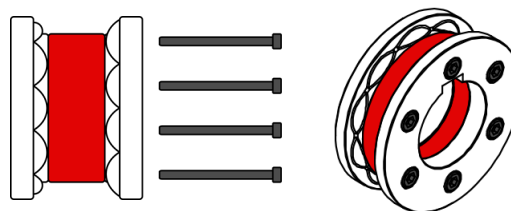

3. Next we place the outer spacer 4 on the machine shaft.

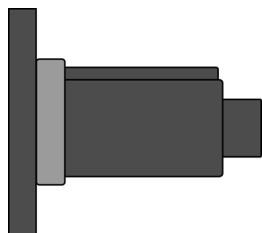

4. Place the pre-mounted roller on the axis of the corresponding machine, top or bottom and tighten the bolts with the Allen key.

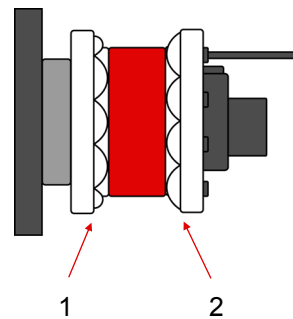

5. Next we place the outer spacer 4 on the machine shaft.

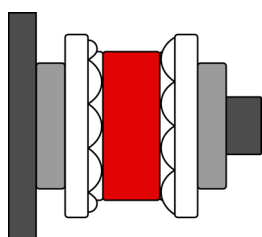

6. Close the roller compartment with the outer cover.

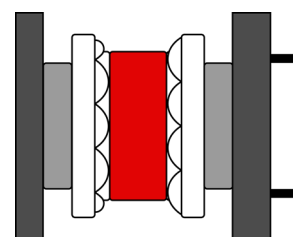

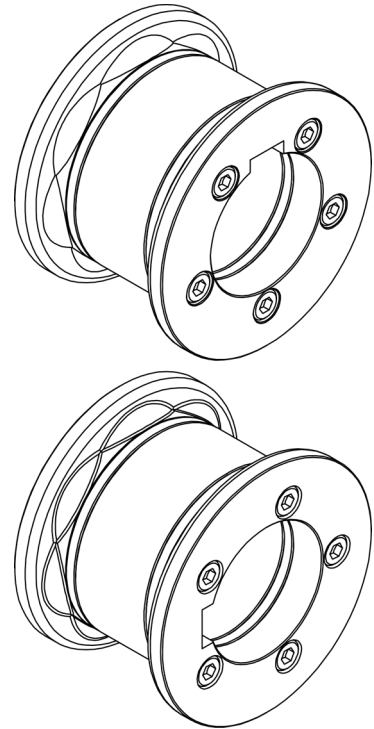

Technical features of Accessories

Set of embossing rollers for 50 and 60 mm pipes

Ref. 140-11-01-00503

Upper roller

Lower Roller

Rollers assembling

Rollers assembling for 50 mm pipe

Rollers assembling for 60 mm pipe

Upper roller

IMPORTANT: In order to achieve a correct use of the machine, it is remarkably essential to place all elements so the total length of the set always remains 80mm.

HAZARD: Never surpass 80mm as maximum length

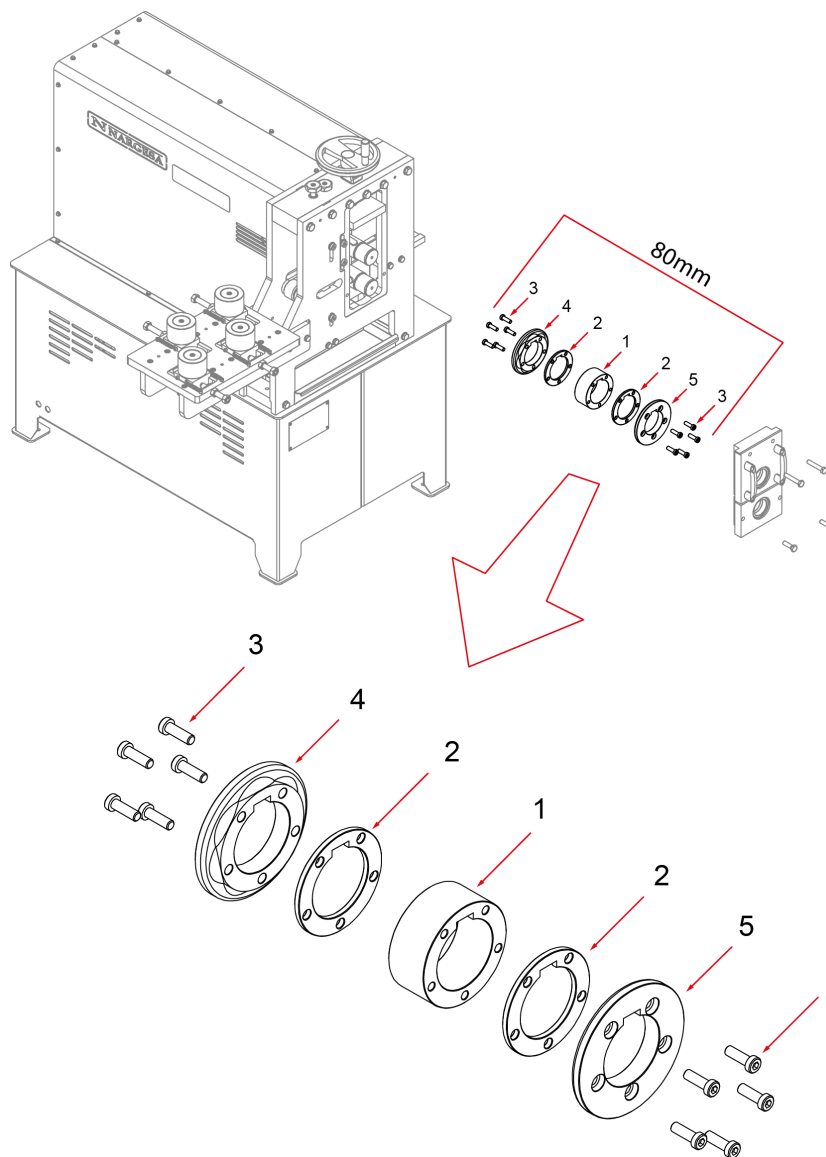

1	125-11-01-00003	SPACER 38 mm	1
2	125-11-01-00004	SPACER 5 mm	2
3	020-D6912-M8X25	ALLEN SMALL HEADED SCREW DIN 6912 M8X25	10
4	125-11-01-00001	LATERAL UPPER INNER ROLLER PIPE 50-60	1
5	125-11-01-00002	LATERAL UPPER OUTER ROLLER PIPE 50-60	1

Lower roller

IMPORTANT: In order to achieve a correct use of the machine, it is remarkably essential to place all elements so the total length of the set always remains 80mm.

HAZARD: Never surpass 80mm as maximum length

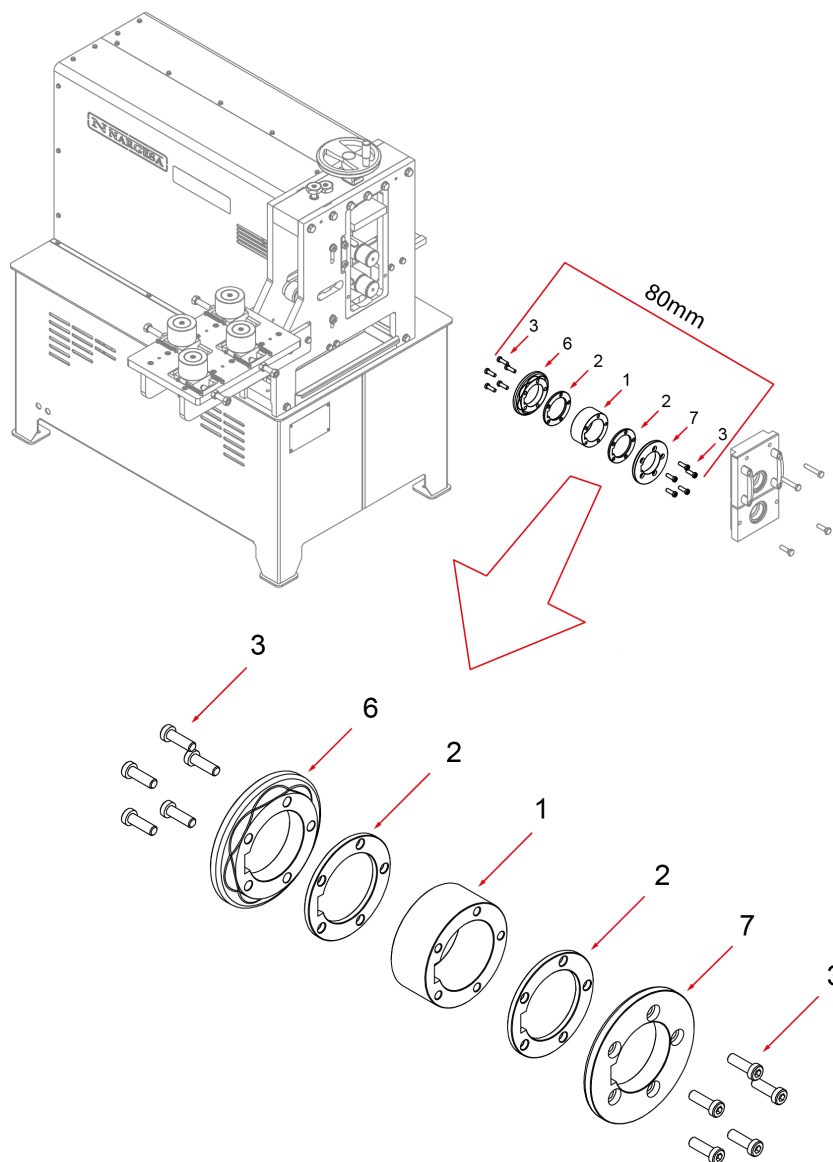

1	125-11-01-00003	SPACER 38 mm	1
2	125-11-01-00004	SPACER 5 mm	2
3	020-D6912-M8X25	ALLEN SMALL HEADED SCREW DIN 6912 M8X25	10
6	125-11-01-00018	LATERAL LOWER INNER ROLLER PIPE 50-60	1
7	125-11-01-00019	LATERAL LOWER OUTER ROLLER PIPE 50-60	1

Rollers assembling

We'll use the different rollers sections depending on the size of the pipe to be embossed.

Then we'll detail every element used for each pipe size, always including sections 4 and 5 (Upper roller) or 6 and 7 (Lower roller) to these sets, which are the ones to perform the embossing operation as such.

Rollers assembling for 50mm pipe

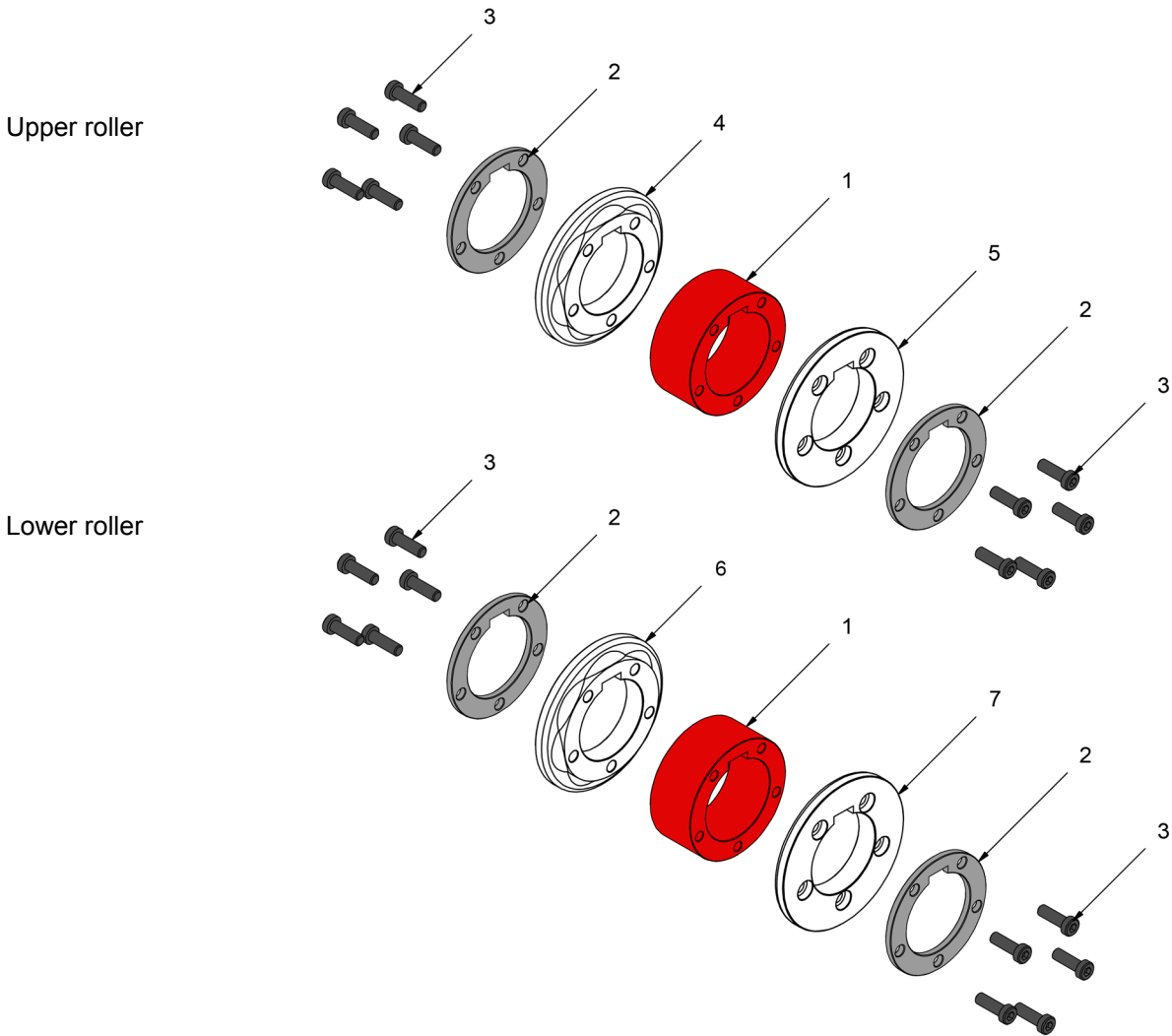

	INSIDE	1	125-11-01-00003	SPACER 38 mm
	EXTERIOR	2	125-11-01-00004	SPACER 5 mm
	SCREWS	3	020-D6912-M8X25	ALLEN SMALL HEADED SCREW DIN 6912 M8X25
		4	125-11-01-00001	LATERAL UPPER INNER ROLLER PIPE 50-60
		5	125-11-01-00002	LATERAL UPPER OUTER ROLLER PIPE 50-60
		6	125-11-01-00018	LATERAL LOWER INNER ROLLER PIPE 50-60
		7	125-11-01-00019	LATERAL LOWER OUTER ROLLER PIPE 50-60

We will use the different sections of the rollers depending on the tube size that we are going to emboss. To assemble the **upper roller of 50mm** we will proceed as follows:

1. We put into order the different sections

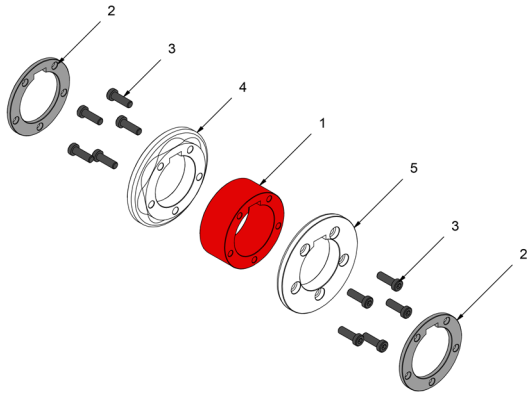

2. We do a pre-assembly, without tightening the bolts, paying special attention in aligning the slots for the pin.

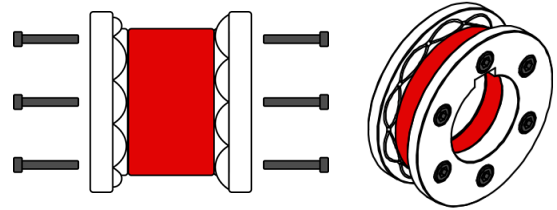

3. Next we place the outer spacer 2 on the upper machine shaft.

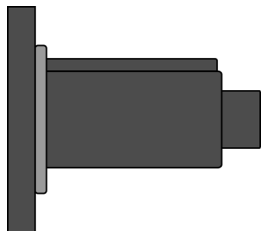

4. Place the pre-mounted roller on the upper axis and tighten the bolts with the Allen key.

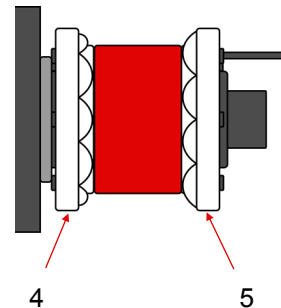

5. We remove the roller from the shaft and we rotate it so that the front part is positioned behind and then we put it in again.

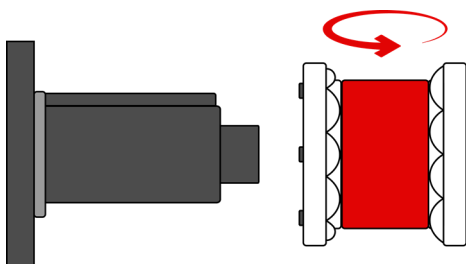

6. Tighten the bolts with the Allen key.

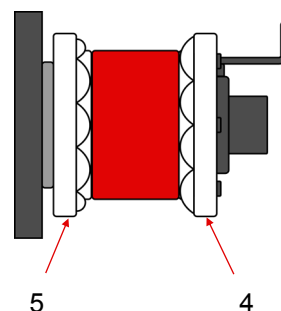

7. We remove the roller from the shaft and we rotate it so that the front part is positioned behind and then we put it in again.

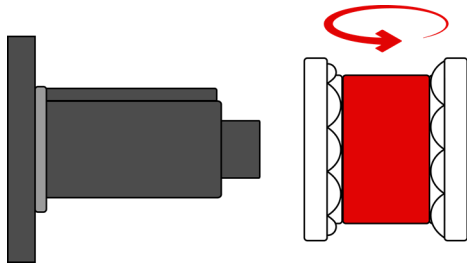

8. Next we place the outer spacer 2 on the upper machine shaft.

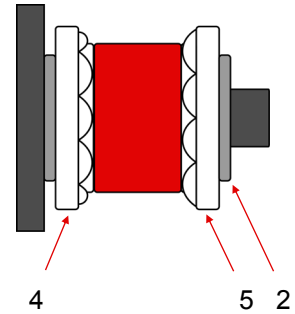

9. Close the roller compartment with the outer cover.

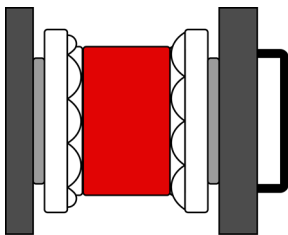

To assemble the **lower roller of 50mm** we will proceed as follows:

1. We put into order the different sections

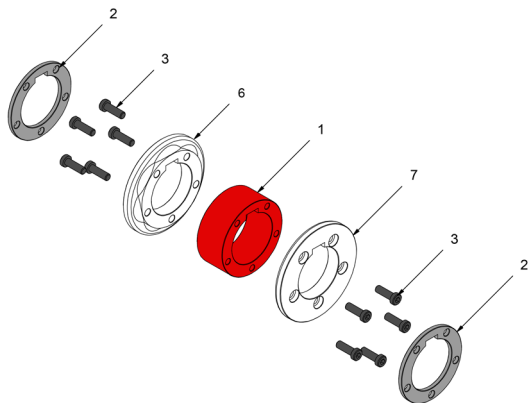

2. We do a pre-assembly, without tightening the bolts, paying special attention in aligning the slots for the pin.

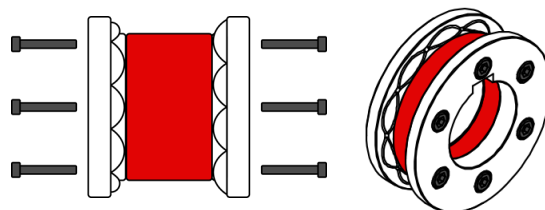

3. Next we place the outer spacer 2 on the lower shaft of the machine.

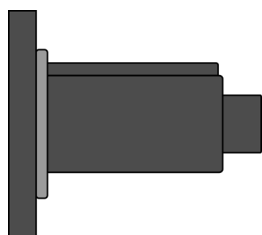

4. We put the pre-mounted roller on the lower shaft of the machine and tighten the bolts with the Allen key.

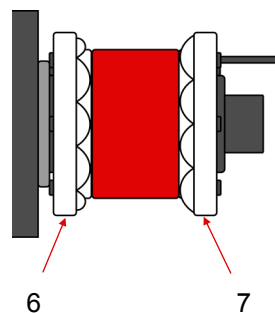

5. We remove the roller from the shaft and we rotate it so that the front part is positioned behind and then we put it in again.

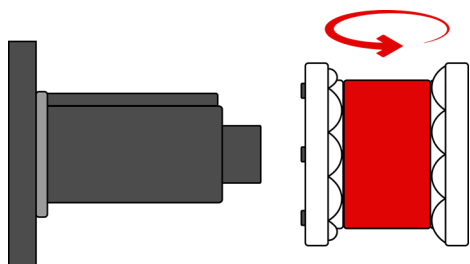

6. Tighten the bolts with the Allen key.

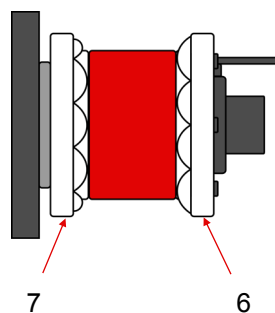

7. We remove the roller from the shaft and we rotate it so that the front part is positioned behind and then we put it in again.

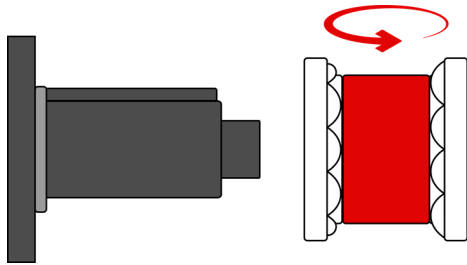

8. Next we place the outer spacer 2 on the lower shaft of the machine.

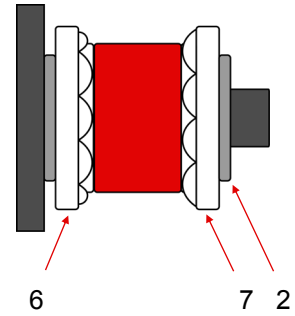

9. Close the roller compartment with the outer cover.

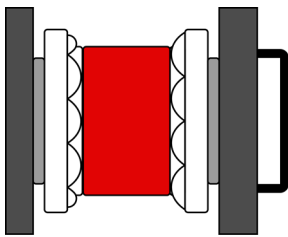

Rollers assembling for 60mm pipe

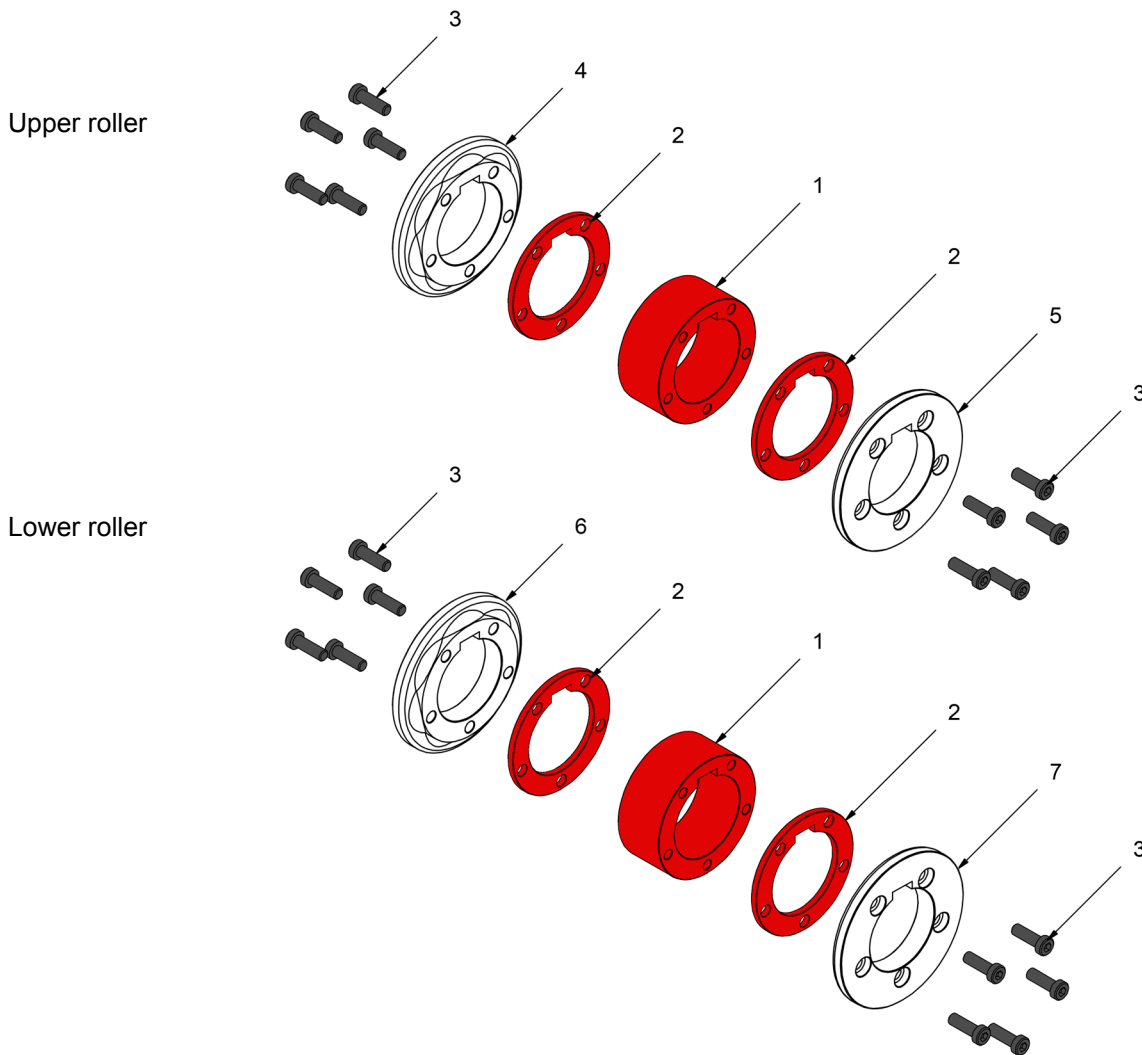

	INSIDE	1	125-11-01-00003	SPACER 38 mm
	INSIDE	2	125-11-01-00004	SPACER 5 mm
	SCREWS	3	020-D6912-M8X25	ALLEN SMALL HEADED SCREW DIN 6912 M8X25
		4	125-11-01-00001	LATERAL UPPER INNER ROLLER PIPE 50-60
		5	125-11-01-00002	LATERAL UPPER OUTER ROLLER PIPE 50-60
		6	125-11-01-00018	LATERAL LOWER INNER ROLLER PIPE 50-60
		7	125-11-01-00019	LATERAL LOWER OUTER ROLLER PIPE 50-60

We will use the different sections of the rollers depending on the tube size that we are going to emboss. To assemble the **upper roller of 60mm** we will proceed as follows:

1. We put into order the different sections

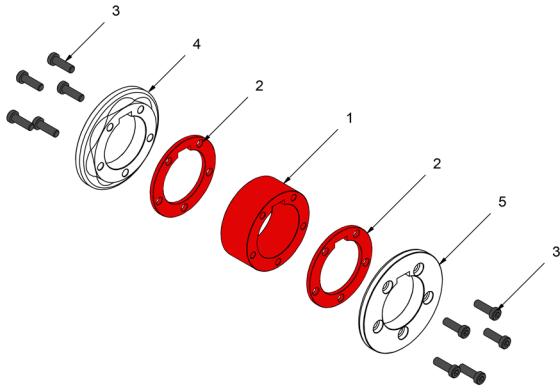

2. We do a pre-assembly, without tightening the bolts, paying special attention in aligning the slots for the pin.

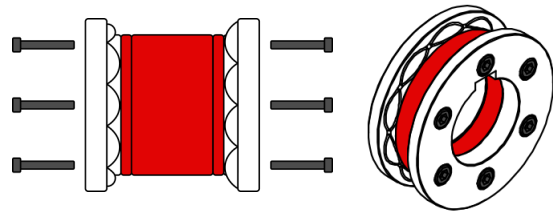

3. Place the pre-mounted roller on the upper axis and tighten the bolts with the Allen key.

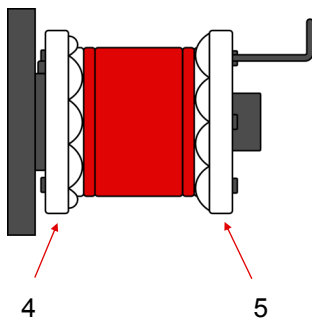

4. We remove the roller from the shaft and we rotate it so that the front part is positioned behind and then we put it in again.

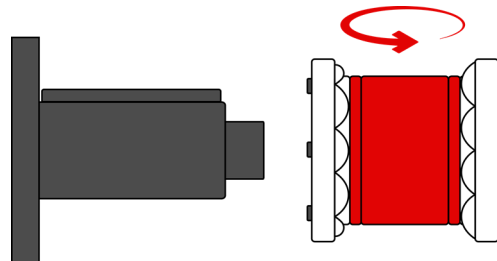

5. Tighten the bolts with the Allen key.

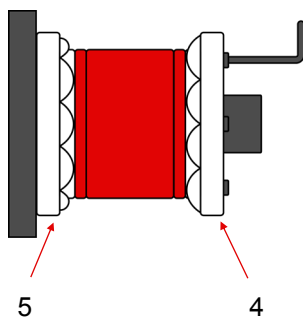

6. We remove the roller from the shaft and we rotate it so that the front part is positioned behind and then we put it in again.

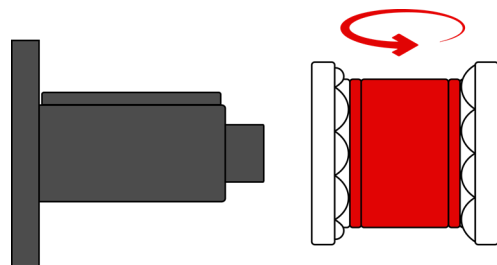

7. We place the roller on its working position

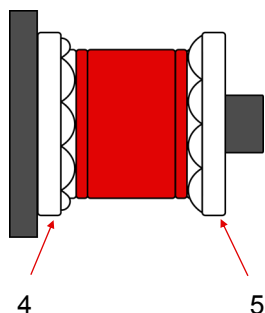

8. Close the roller compartment with the outer cover.

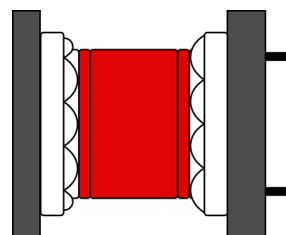

To assemble the **lower roller of 60mm** we will proceed as follows:

1. We put into order the different sections

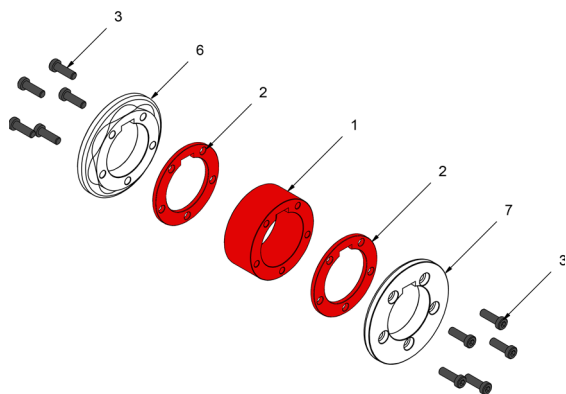

2. We do a pre-assembly, without tightening the bolts, paying special attention in aligning the slots for the pin.

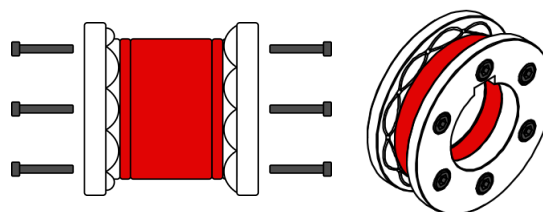

3. Place the pre-mounted roller on the lower axis and tighten the bolts with the Allen key.

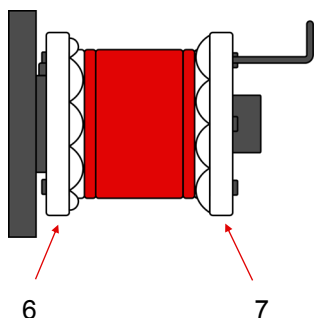

4. We remove the roller from the shaft and we rotate it so that the front part is positioned behind and then we put it in again.

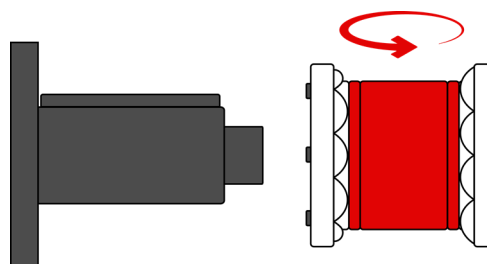

5. Tighten the bolts with the Allen key.

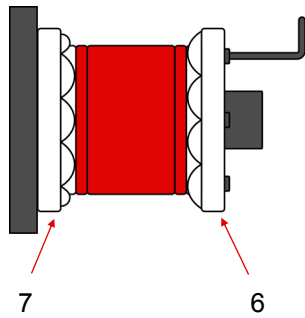

6. We remove the roller from the shaft and we rotate it so that the front part is positioned behind and then we put it in again.

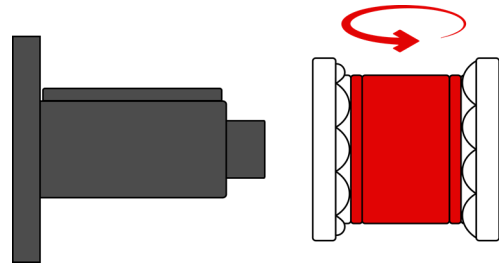

7. We place the roller on its working position

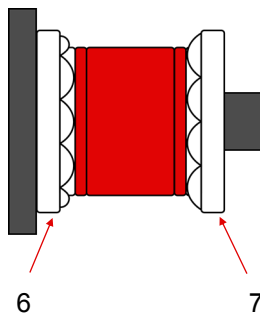

8. Close the roller compartment with the outer cover.

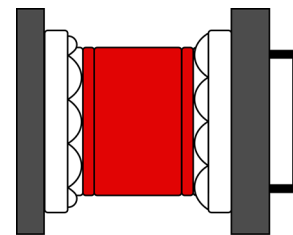

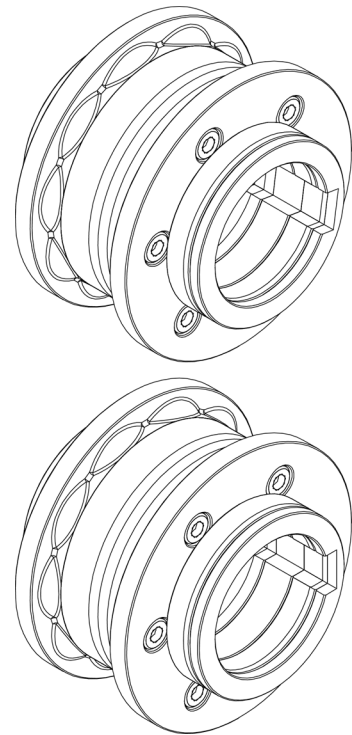

Technical features of Accessories
Set of embossing rollers
for 1" 1/2, 2" and 2" 1/2 inches pipes

Ref. 140-11-01-00507

Upper roller

Lower Roller

Rollers assembling

Rollers assembling for 1" 1/2 inches pipe

Rollers assembling for 2" inches pipe

Rollers assembling for 2" 1/2 inches pipe

Upper roller

IMPORTANT: In order to achieve a correct use of the machine, it is remarkably essential to place all elements so the total length of the set always remains 80mm.

HAZARD: Never surpass 80mm as maximum length

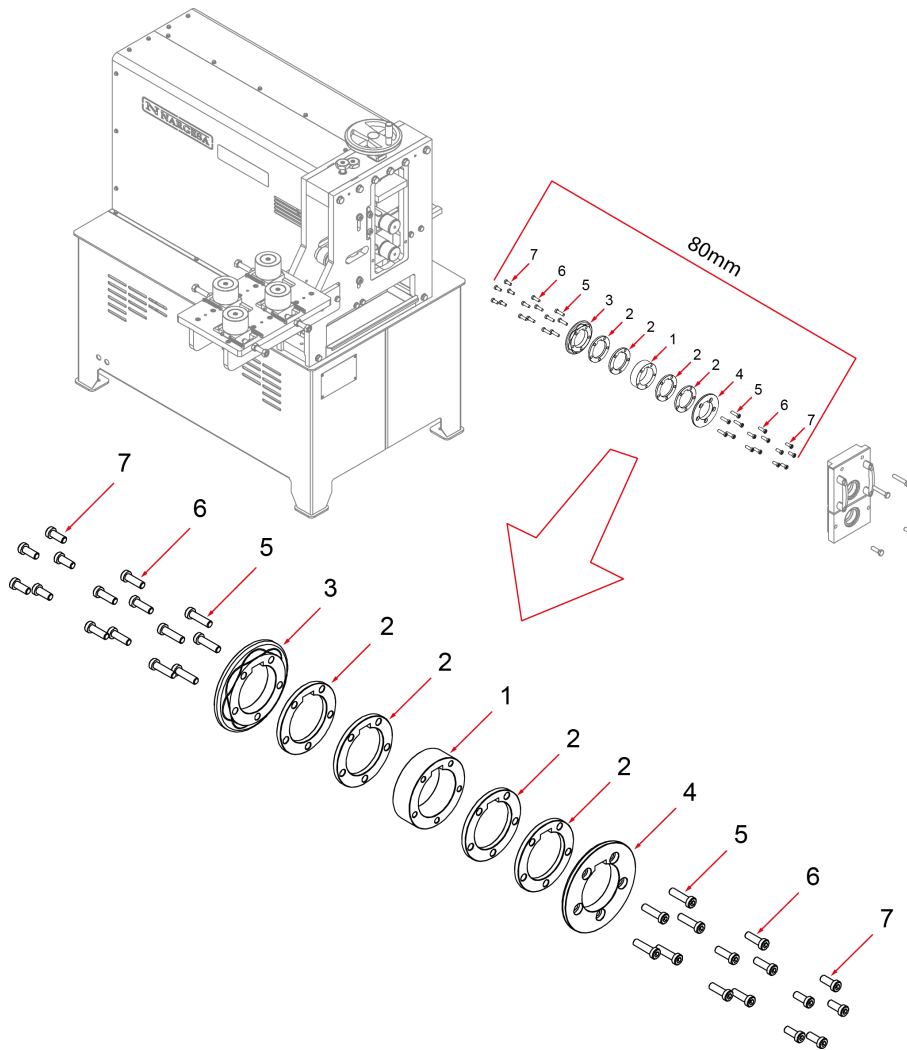

1	125-11-01-00016	SPACER 27,1 mm	1
2	125-11-01-00017	SPACER 6,25 mm	4
3	125-11-01-00014	LATERAL UPPER INNER ROLLER PIPE 1"1/2, 2" AND 2"1/2	1
4	125-11-01-00015	LATERAL UPPER OUTER ROLLER PIPE 1"1/2, 2" AND 2"1/2	1
5	020-D6912-M8X30	ALLEN SMALL HEADED SCREW DIN 6912 M8X30	10
6	020-D6912-M8X25	ALLEN SMALL HEADED SCREW DIN 6912 M8X25	10
7	020-D6912-M8X20	ALLEN SMALL HEADED SCREW DIN 6912 M8X20	10

Lower roller

IMPORTANT: In order to achieve a correct use of the machine, it is remarkably essential to place all elements so the total length of the set always remains 80mm.



HAZARD: Never surpass 80mm as maximum length

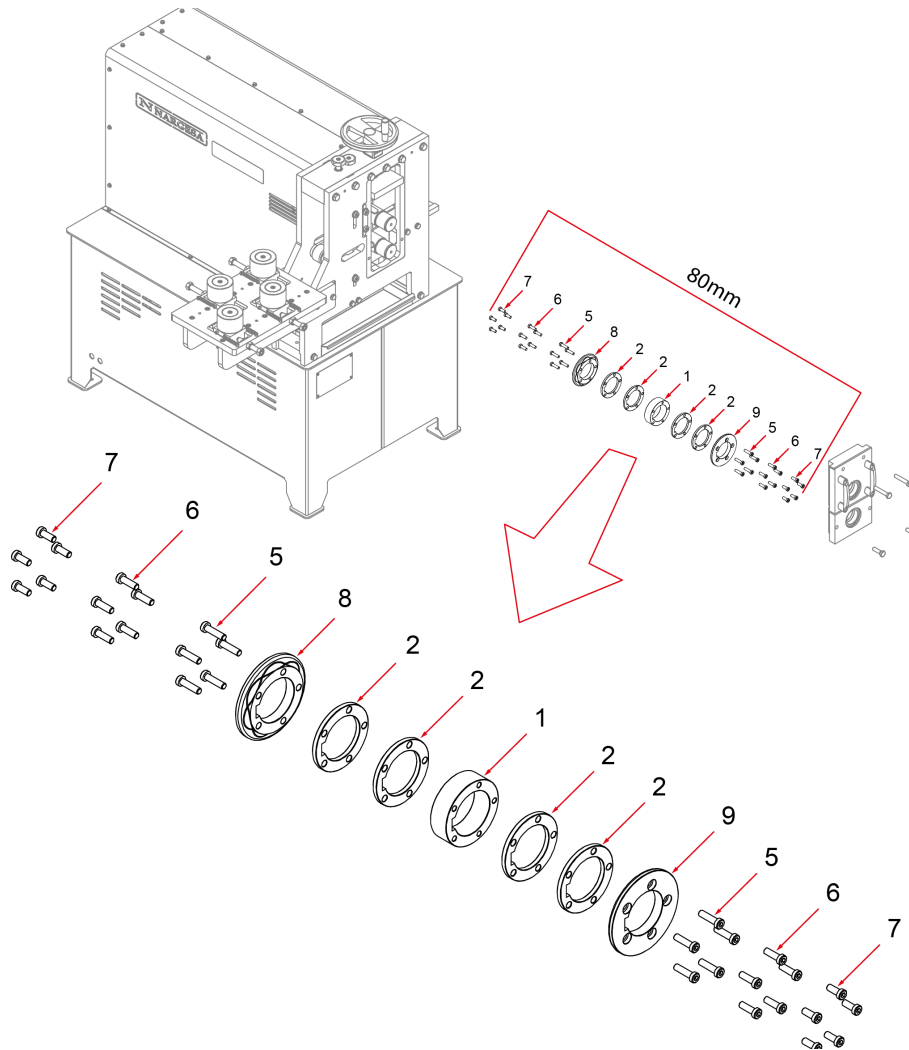

1	125-11-01-00016	SPACER 27,1 mm	1
2	125-11-01-00017	SPACER 6,25 mm	4
5	020-D6912-M8X30	ALLEN SMALL HEADED SCREW DIN 6912 M8X30	10
6	020-D6912-M8X25	ALLEN SMALL HEADED SCREW DIN 6912 M8X25	10
7	020-D6912-M8X20	ALLEN SMALL HEADED SCREW DIN 6912 M8X20	10
8	125-11-01-00024	LATERAL LOWER INNER ROLLER PIPE 1"1/2, 2" AND 2"1/2	1
9	125-11-01-00025	LATERAL LOWER OUTER ROLLER PIPE 1"1/2, 2" AND 2"1/2	1

Rollers assembling

We'll use the different rollers sections depending on the size of the pipe to be embossed.

Then we'll detail every element used for each pipe size, always including sections 3 and 4 (Upper roller) or 8 and 9 (Lower roller) to these sets, which are the ones to perform the embossing operation as such.

Rollers assembling for 1" 1/2 inches pipe

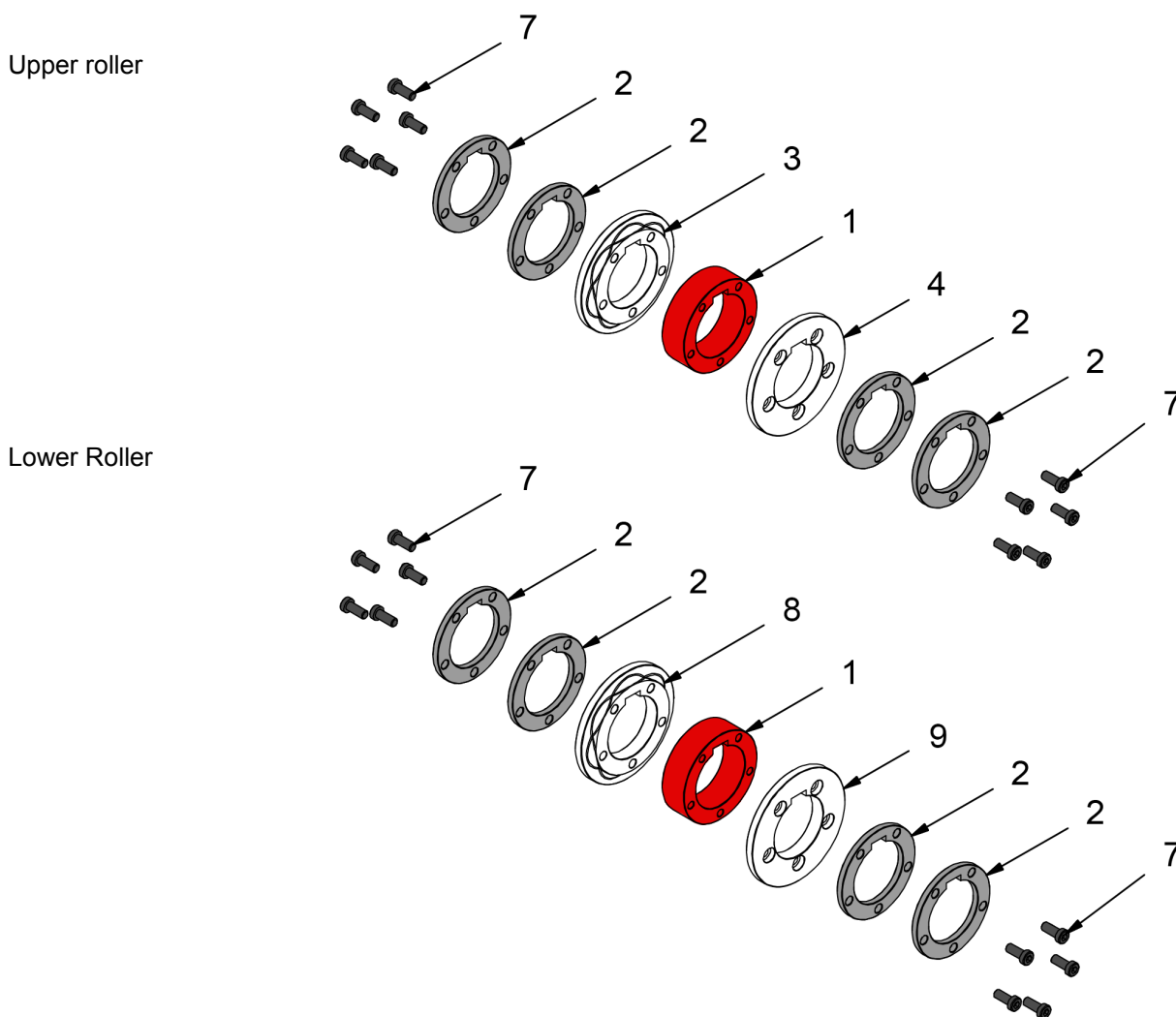

	INSIDE	1	125-11-01-00016	SPACER 27,1 mm
	EXTERIOR	2	125-11-01-00017	SPACER 6,25 mm
	EXTERIOR	2	125-11-01-00017	SPACER 6,25 mm
	SCREWS	7	020-D6912-M8X20	ALLEN SMALL HEADED SCREW DIN 6912 M8X20
		3	125-11-01-00014	LATERAL UPPER INNER ROLLER PIPE 1"1/2, 2" AND 2"1/2
		4	125-11-01-00015	LATERAL UPPER OUTER ROLLER PIPE 1"1/2, 2" AND 2"1/2
		8	125-11-01-00024	LATERAL LOWER INNER ROLLER PIPE 1"1/2, 2" AND 2"1/2
		9	125-11-01-00025	LATERAL LOWER OUTER ROLLER PIPE 1"1/2, 2" AND 2"1/2

We will use the different sections of the rollers depending on the tube size that we are going to emboss. To assemble the **upper roller of 1" 1/2 inches** we will proceed as follows:

1. We put into order the different sections

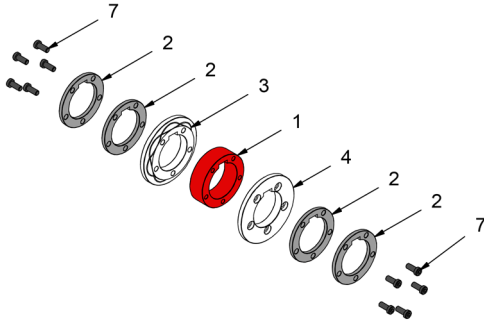

2. We do a pre-assembly, without tightening the bolts, paying special attention in aligning the slots for the pin.

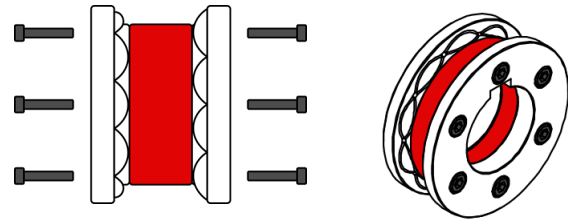

3. Next we place the outer spacers 2 on the upper shaft of the machine.

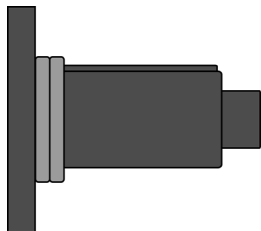

4. Place the pre-mounted roller on the upper axis and tighten the bolts with the Allen key.

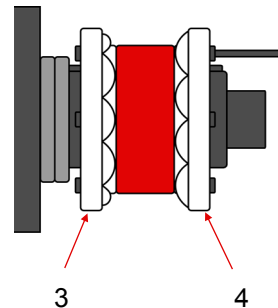

5. We remove the roller from the shaft and we rotate it so that the front part is positioned behind and then we put it in again.

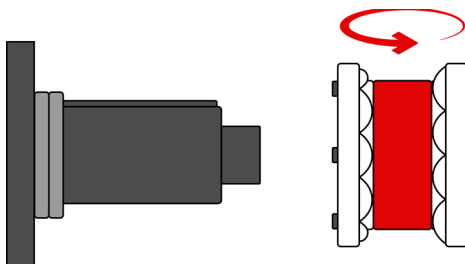

6. Tighten the bolts with the Allen key.

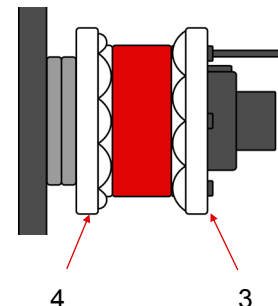

7. We remove the roller from the shaft and we rotate it so that the front part is positioned behind and then we put it in again.

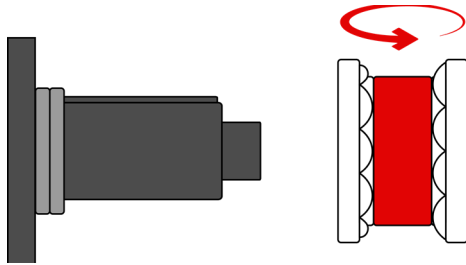

8. Next we place the outer spacers 2 on the upper shaft of the machine.

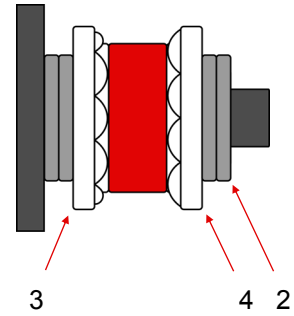

9. Close the roller compartment with the outer cover.

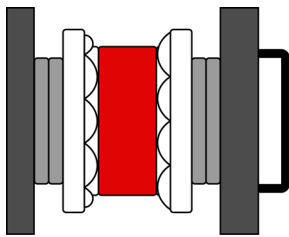

To assemble the **lower roller 1" 1/2 inches** we will proceed as follows:

1. We put into order the different sections

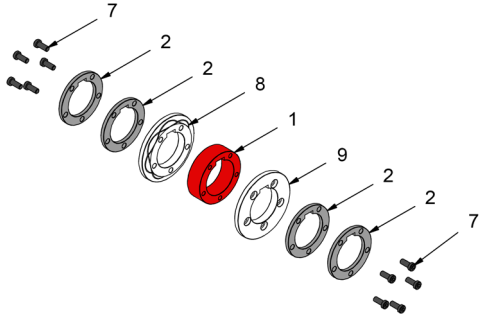

2. We do a pre-assembly, without tightening the bolts, paying special attention in aligning the slots for the pin.

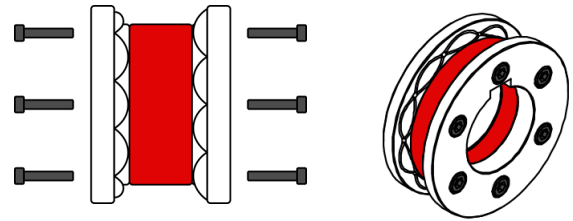

3. Next we place the outer spacers 2 on the lower shaft of the machine.

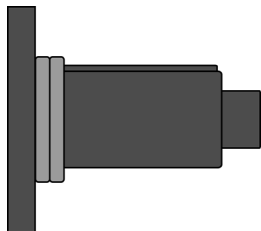

4. Place the pre-mounted roller on the lower axis and tighten the bolts with the Allen key.

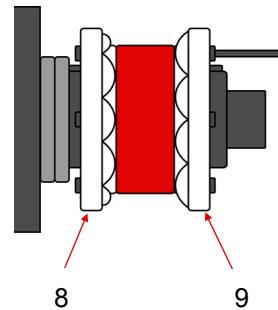

5. We remove the roller from the shaft and we rotate it so that the front part is positioned behind and then we put it in again.

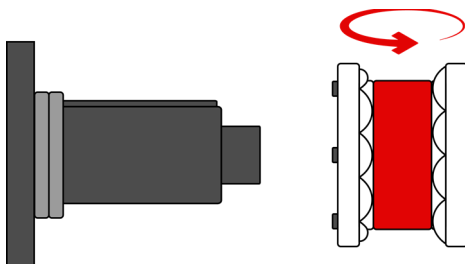

6. Tighten the bolts with the Allen key.

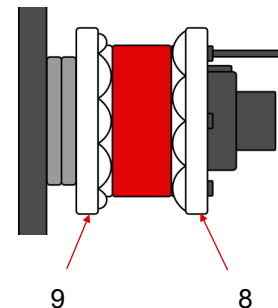

7. We remove the roller from the shaft and we rotate it so that the front part is positioned behind and then we put it in again.

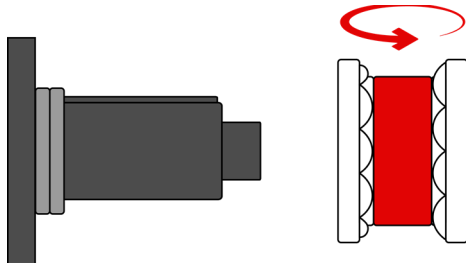

8. Next we place the outer spacers 2 on the lower shaft of the machine.

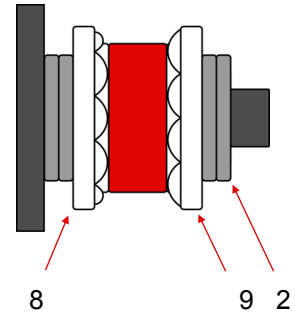

9. Close the roller compartment with the outer cover.

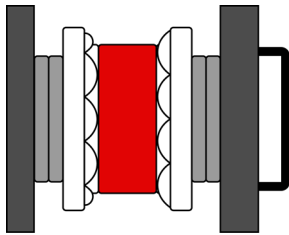

Rollers assembling for 2" inches pipe

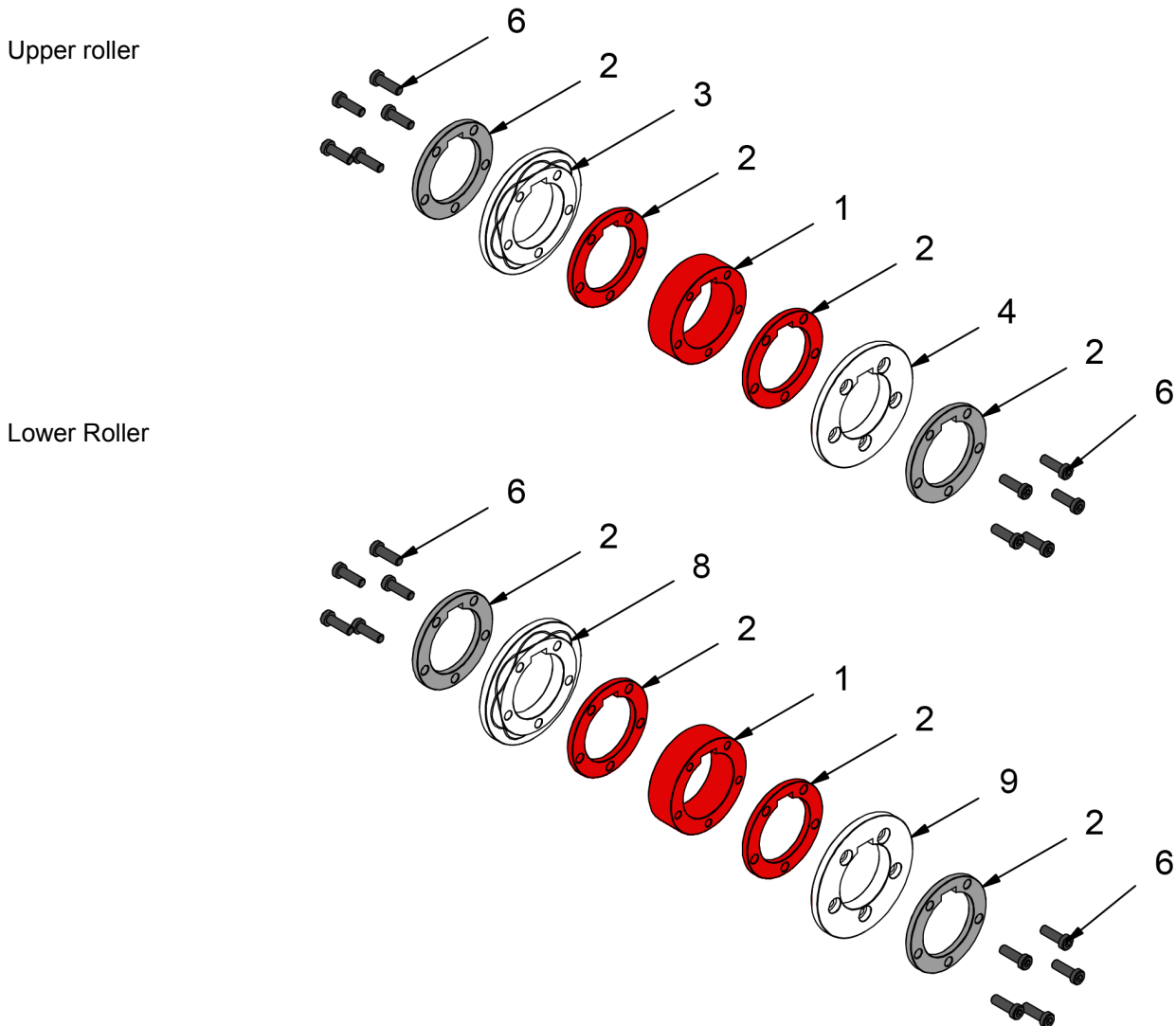

	INSIDE	1	125-11-01-00016	SPACER 27,1 mm
	INSIDE	2	125-11-01-00017	SPACER 6,25 mm
	EXTERIOR	2	125-11-01-00017	SPACER 6,25 mm
	SCREWS	6	020-D6912-M8X25	ALLEN SMALL HEADED SCREW DIN 6912 M8X25
		3	125-11-01-00014	LATERAL UPPER INNER ROLLER PIPE 1"1/2, 2" AND 2"1/2
		4	125-11-01-00015	LATERAL UPPER OUTER ROLLER PIPE 1"1/2, 2" AND 2"1/2
		8	125-11-01-00024	LATERAL LOWER INNER ROLLER PIPE 1"1/2, 2" AND 2"1/2
		9	125-11-01-00025	LATERAL LOWER OUTER ROLLER PIPE 1"1/2, 2" AND 2"1/2

To assemble the **upper roller 2" inches** we will proceed as follows:

1. We put into order the different sections

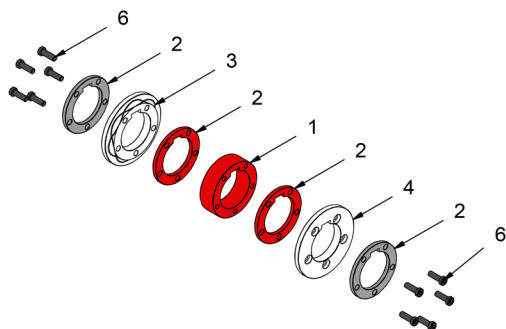

2. We do a pre-assembly, without tightening the bolts, paying special attention in aligning the slots for the pin.

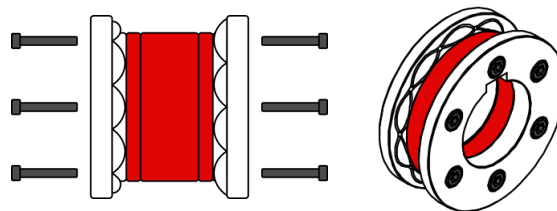

3. Next we place the outer spacer 2 on the upper shaft of the machine

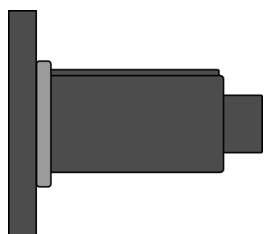

4. Place the pre-mounted roller on the upper axis and tighten the bolts with the Allen key.

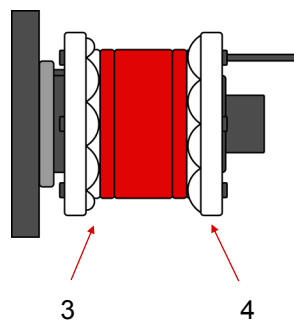

5. We remove the roller from the shaft and we rotate it so that the front part is positioned behind and then we put it in again.

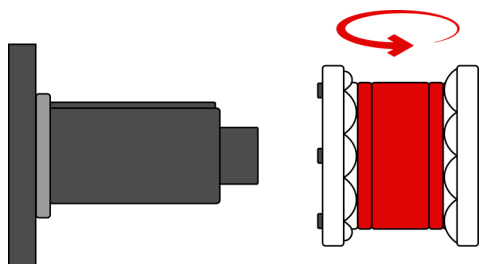

6. Tighten the bolts with the Allen key.

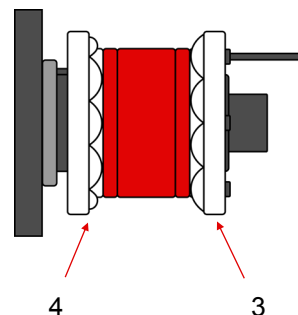

7. We remove the roller from the shaft and we rotate it so that the front part is positioned behind and then we put it in again.

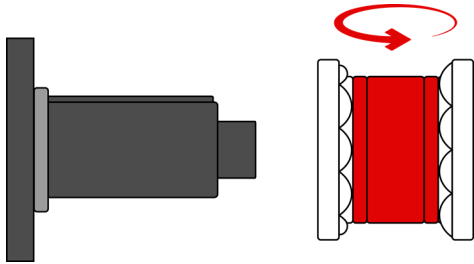

8. Next we place the outer spacer 2 on the upper shaft of the machine

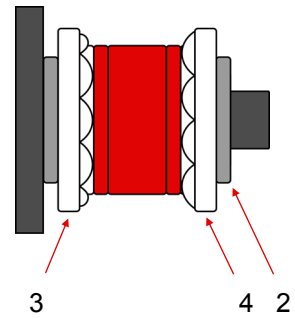

9. Close the roller compartment with the outer cover.

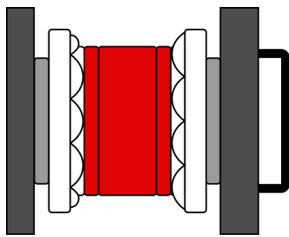

To assemble the **lower roller 2" inches** we will proceed as follows:

1. We put into order the different sections

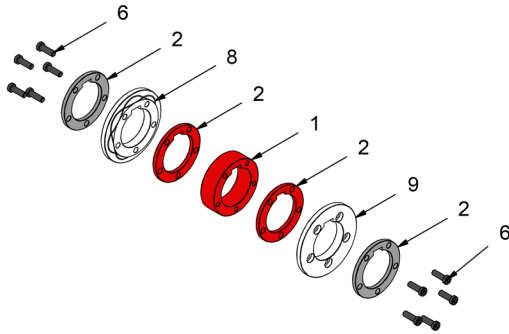

2. We do a pre-assembly, without tightening the bolts, paying special attention in aligning the slots for the pin.

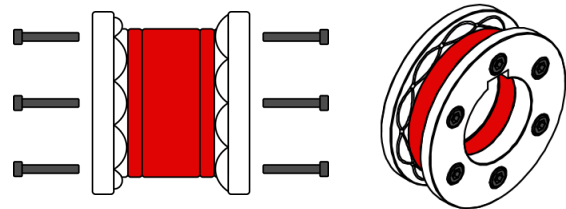

3. Next we place the outer spacer 2 on the lower shaft of the machine.

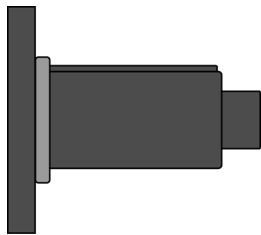

4. We put the pre-mounted roller on the lower shaft of the machine and tighten the bolts with the Allen key.

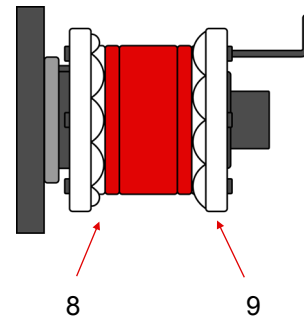

5. We remove the roller from the shaft and we rotate it so that the front part is positioned behind and then we put it in again.

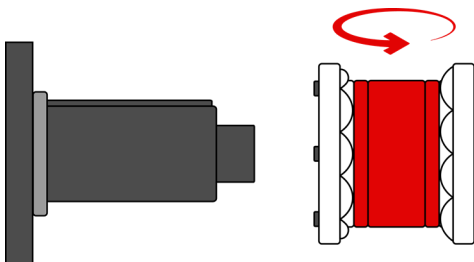

6. Tighten the bolts with the Allen key.

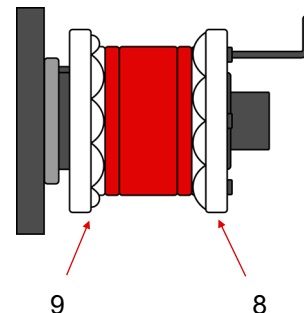

7. We remove the roller from the shaft and we rotate it so that the front part is positioned behind and then we put it in again.

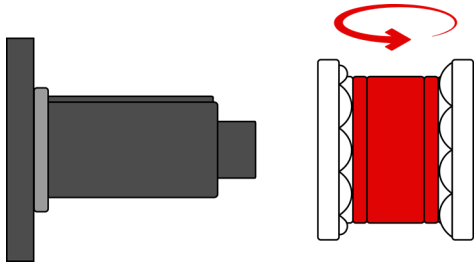

8. Next we place the outer spacer 2 on the lower shaft of the machine.

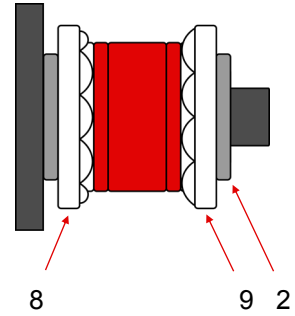

9. Close the roller compartment with the outer cover.

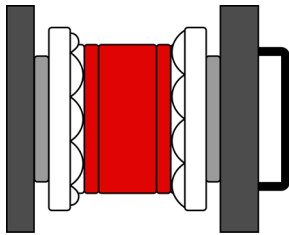

Rollers assembling for 2" 1/2 inches pipe

Upper roller

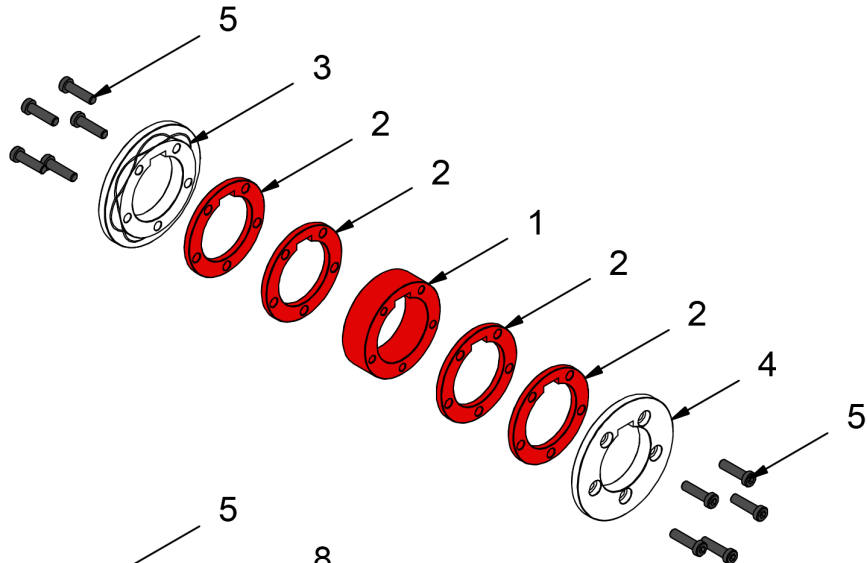

Lower Roller

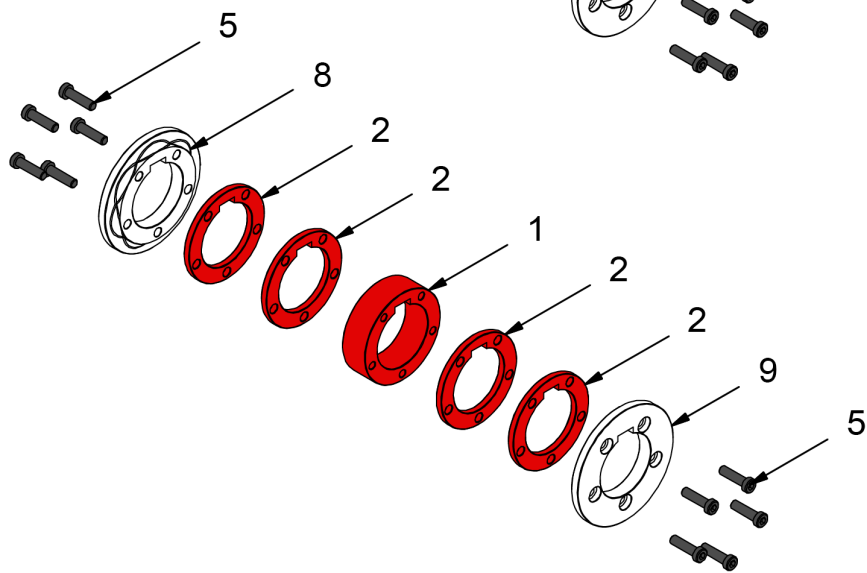

	INSIDE	1	125-11-01-00016	SPACER 27,1 mm
	INSIDE	2	125-11-01-00017	SPACER 6,25 mm
	INSIDE	2	125-11-01-00017	SPACER 6,25 mm
	SCREWS	5	020-D6912-M8X30	ALLEN SMALL HEADED SCREW DIN 6912 M8X30
		3	125-11-01-00014	LATERAL UPPER INNER ROLLER PIPE 1"1/2, 2" AND 2"1/2
		4	125-11-01-00015	LATERAL UPPER OUTER ROLLER PIPE 1"1/2, 2" AND 2"1/2
		8	125-11-01-00024	LATERAL LOWER INNER ROLLER PIPE 1"1/2, 2" AND 2"1/2
		9	125-11-01-00025	LATERAL LOWER OUTER ROLLER PIPE 1"1/2, 2" AND 2"1/2

To assemble the **upper roller 2" 1/2 inches** we will proceed as follows:

1. We put into order the different sections

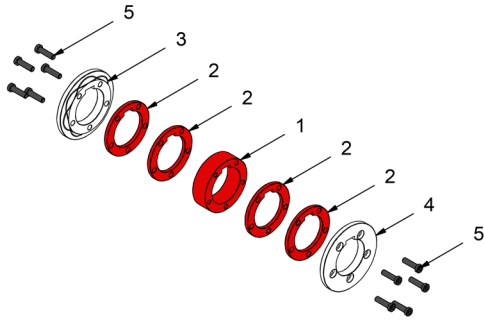

2. We do a pre-assembly, without tightening the bolts, paying special attention in aligning the slots for the pin.

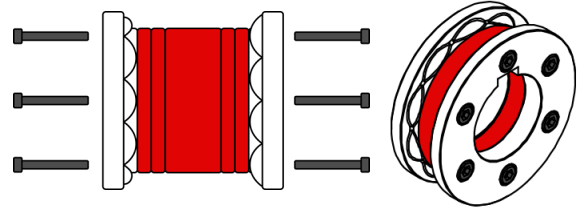

3. Place the pre-mounted roller on the upper axis and tighten the bolts with the Allen key.

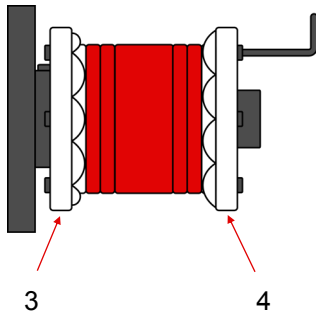

4. We remove the roller from the shaft and we rotate it so that the front part is positioned behind and then we put it in again.

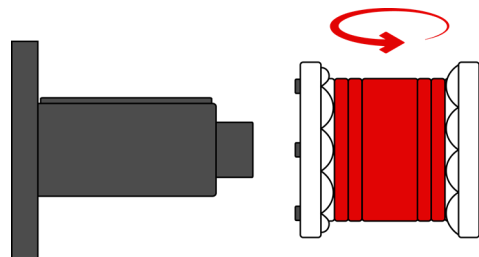

5. Tighten the bolts with the Allen key.

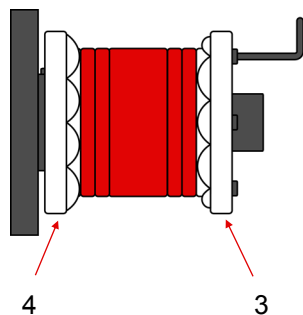

6. We remove the roller from the shaft and we rotate it so that the front part is positioned behind and then we put it in again.

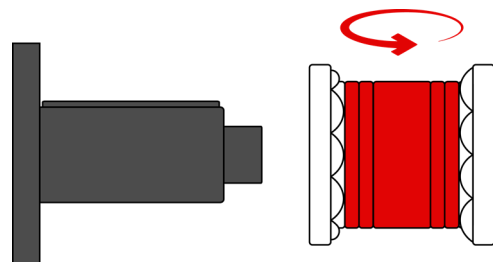

7. We place the roller on its working position

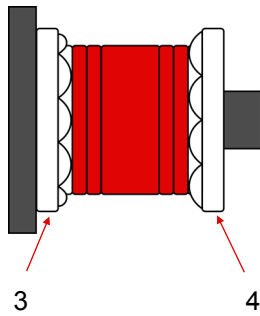

8. Close the roller compartment with the outer cover.

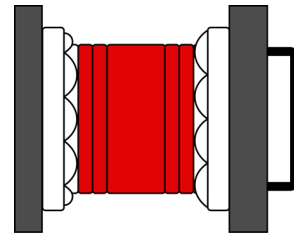

To assemble the **lower roller 2" 1/2 inches** we will proceed as follows:

1. We put into order the different sections

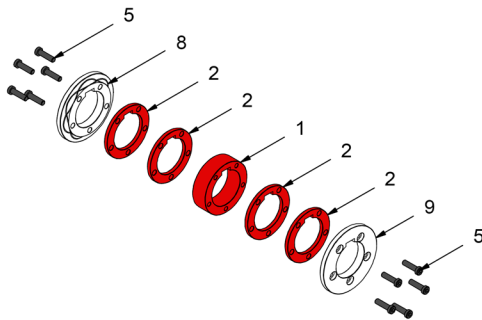

2. We do a pre-assembly, without tightening the bolts, paying special attention in aligning the slots for the pin.

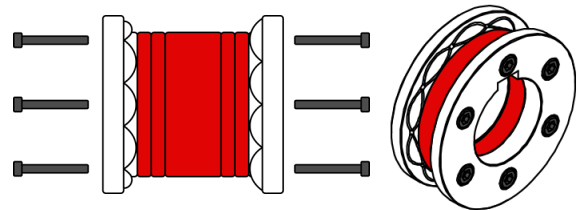

3. We put the pre-mounted roller on the lower shaft of the machine and tighten the bolts with the Allen key.

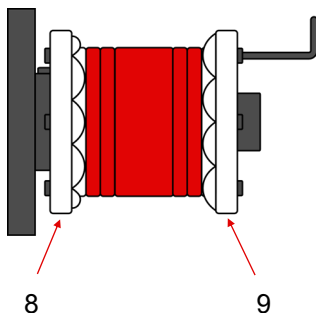

4. We remove the roller from the shaft and we rotate it so that the front part is positioned behind and then we put it in again.

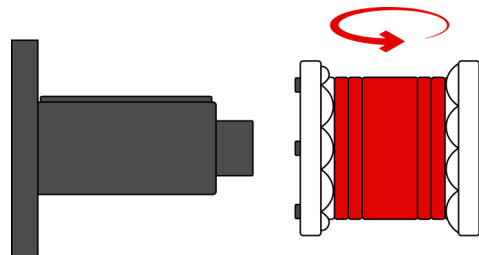

5. Tighten the bolts with the Allen key.

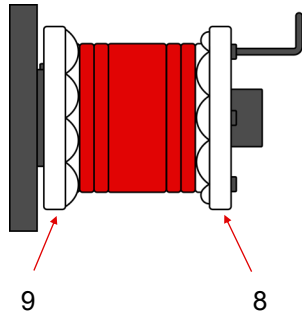

6. We remove the roller from the shaft and we rotate it so that the front part is positioned behind and then we put it in again.

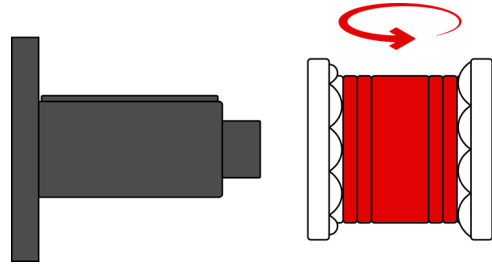

7. We place the roller on its working position

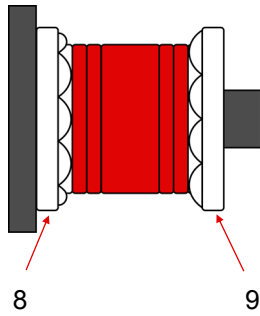

8. Close the roller compartment with the outer cover.

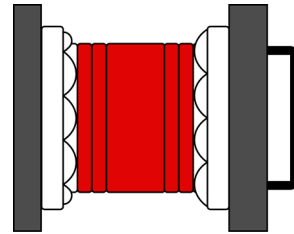

WARRANTY REGISTRATION

1. Among www.nargesa.com on our site
2. Select the menu **Warranty Registration**

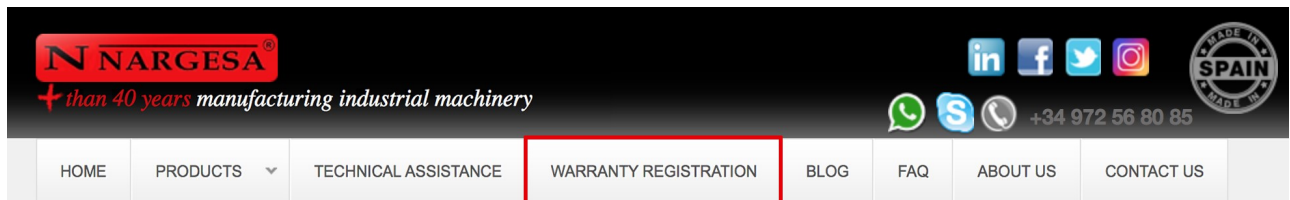

3. Complete the form with your details and press

Submit

4. **Message Sent:** confirms your data has been successfully sent to Prada Nargesa SL. Your machine has been registered and has a warranty of three years in total.

Your request has been sent correctly. We will contact you right away to confirm that your warranty has been extended up to three years