

END WROUGHT IRON MACHINE

NF70

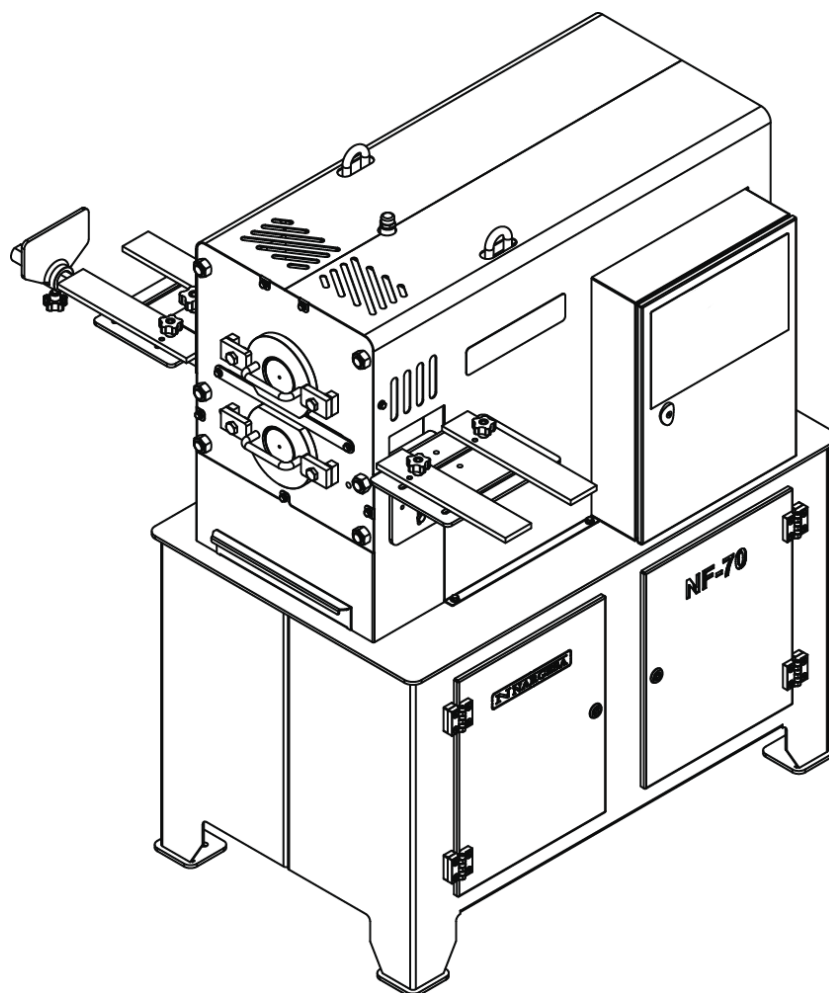

INSTRUCTIONS BOOK

PRADA NARGESA, S.L

Ctra. de Garrigàs a Sant Miquel s/n · 17476 Palau de Santa Eulàlia (Girona) SPAIN
Tel. +34 972568085 · nargesa@nargesa.com · www.nargesa.com

Thank you for choosing our machines



www.narges.com

INDEX

1. CHARACTERISTICS OF THE MACHINE	4
1.1. General dimensions	4
1.2. Description of the machine	4
1.3. Identification of the machine	5
1.4. General features	6
1.5. Identification of safety protection devices	6
2. TRANSPORTATION AND STORAGE	7
2.1. Transportation	7
2.2. Storage conditions	7
3. MAINTENANCE AND CLEANING	8
3.1. General maintenance	8
3.2. Cleaning	8
4. INSTALLMENT AND STARTING UP	9
4.1. Location of the machine	9
4.2. Working site	9
4.3. Admissible outer conditions	10
4.4. Electrical connections	10
5. OPERATIONS	11
5.1. Description of control panel	11
5.1.1. Description of keypad	11
5.1.2. Screen messages	12
5.2. Language selection.....	14
5.3. Initialisation of machine	14
5.4. Change of rollers	15
5.5. Manual operational mode	16
5.6. Simple mode	16
5.7. Semi-automatic mode	17
5.8. Unlocking the machine	17
5.9. Speed Adjustment	17
6. POSSIBLE FAULTS	18
7. WARNINGS	19
8. DESCRIPTION AND ASSEMBLY OF TOOLING	20
8.1. Points at the end extreme	20
8.1.1. Description of elements	20
8.1.2. Working procedure	21
8.2. Fish tail ends	22
8.2.1. Description of elements	22
8.2.2. Working procedure	23

8.3. Marked on the middle part of the bar	24
8.3.1. Flat marking	24
8.3.1.1. Description of elements	24
8.3.1.2. Working procedure	25
8.3.2. Trilobular marking	26
8.3.2.1. Description of elements	26
8.3.2.2. Working procedure	27
9.TOOLING	28
9.1. Standard tooling	28
9.2. Optional tooling	28

TECHNICAL ANNEX

1. CHARACTERISTICS OF THE MACHINE

1.1. General dimensions

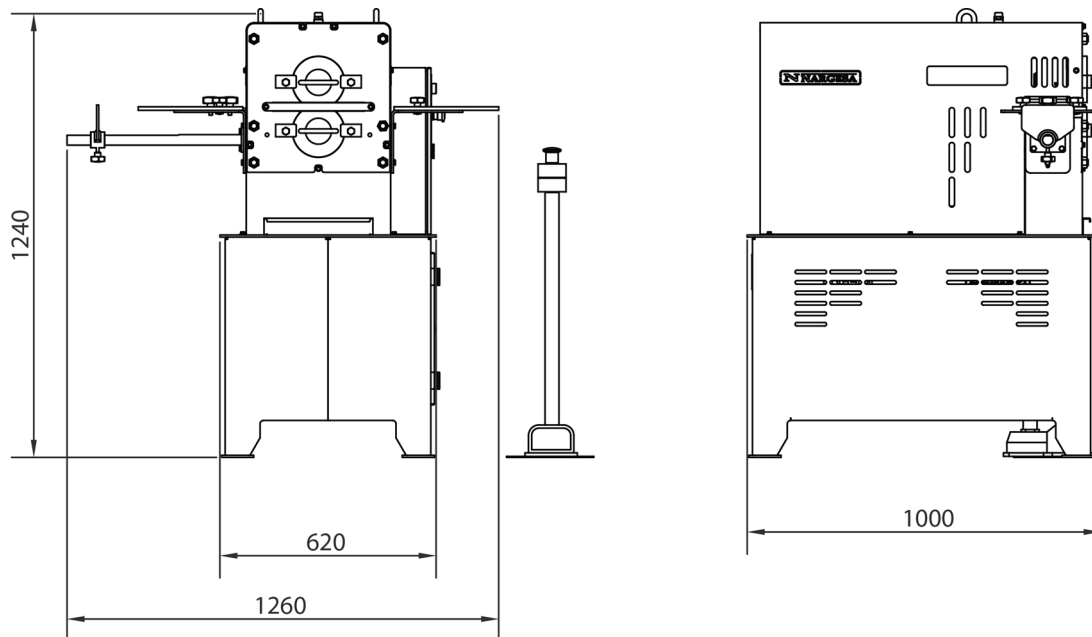

1.2. Description of the machine

The purpose of the machine NF70 NARGESA is to shape up hot metal (forging) to the desired shape by mechanical deformation.

The final result of the part is given by the different forming rollers.

NOTE:

Any application other than the one specified on this book and for which this machine has been designed can cause damage to the machine or the user, in this case the manufacturer does not hold any responsibility

1.3. Identification of the machine

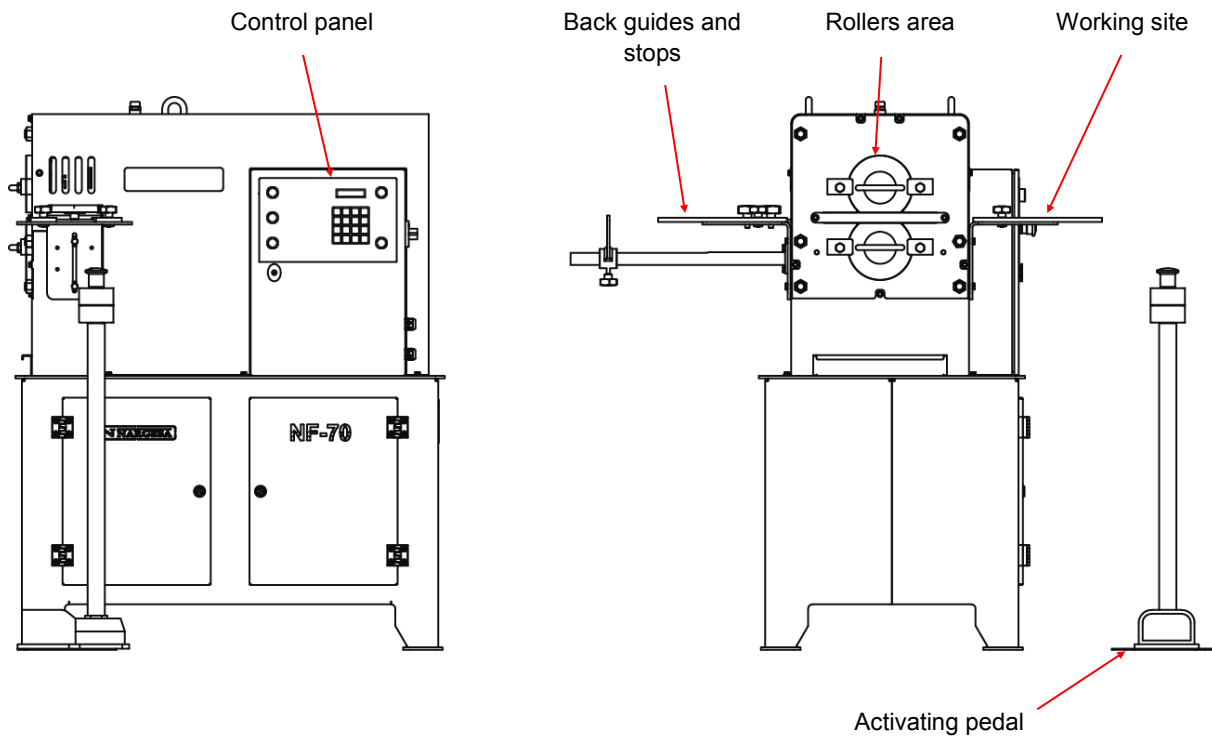

N NARGESA®		www.nargesa.com	CE
PRADA NARGESA, S.L. - CTRA. DE GARRIGAS A SANT MIGUEL S/N 17476 PALAU DE STA. EULALIA (GIRONA) SPAIN - TEL.(+34) 972568085			
TRADEMARK	NARGESA	MODEL	NF-70
YEAR OF MANUFACTURE		SERIAL N°	
DIMENSIONS	1240X1000X1260	mm.	WEIGHT 450 Kg.
POWER	5.5 Kw.	INTENSITY	22.1/12.8 A. Hz 50/60 rpm 1400 VOLTAGE 230/400V
POWER	Kw.	INTENSITY	A. Hz 50/60 rpm VOLTAGE 230/400V
RPM OUT - 20			

1.4. General features

- Electric motor 5.5 KW power (7.5 HP) to 1460 r.p.m.
- Tension Power 230 or 400 V three-phase
- Electrical consumption 22/12 A
- Working speed 20 rpm at 50 Hz
- Weight 450 Kg
- Maximum capacity Mild steel square of 20x20mm
 Mild steel flat bar of 40x10mm

1.5. Identification of safety protection devices

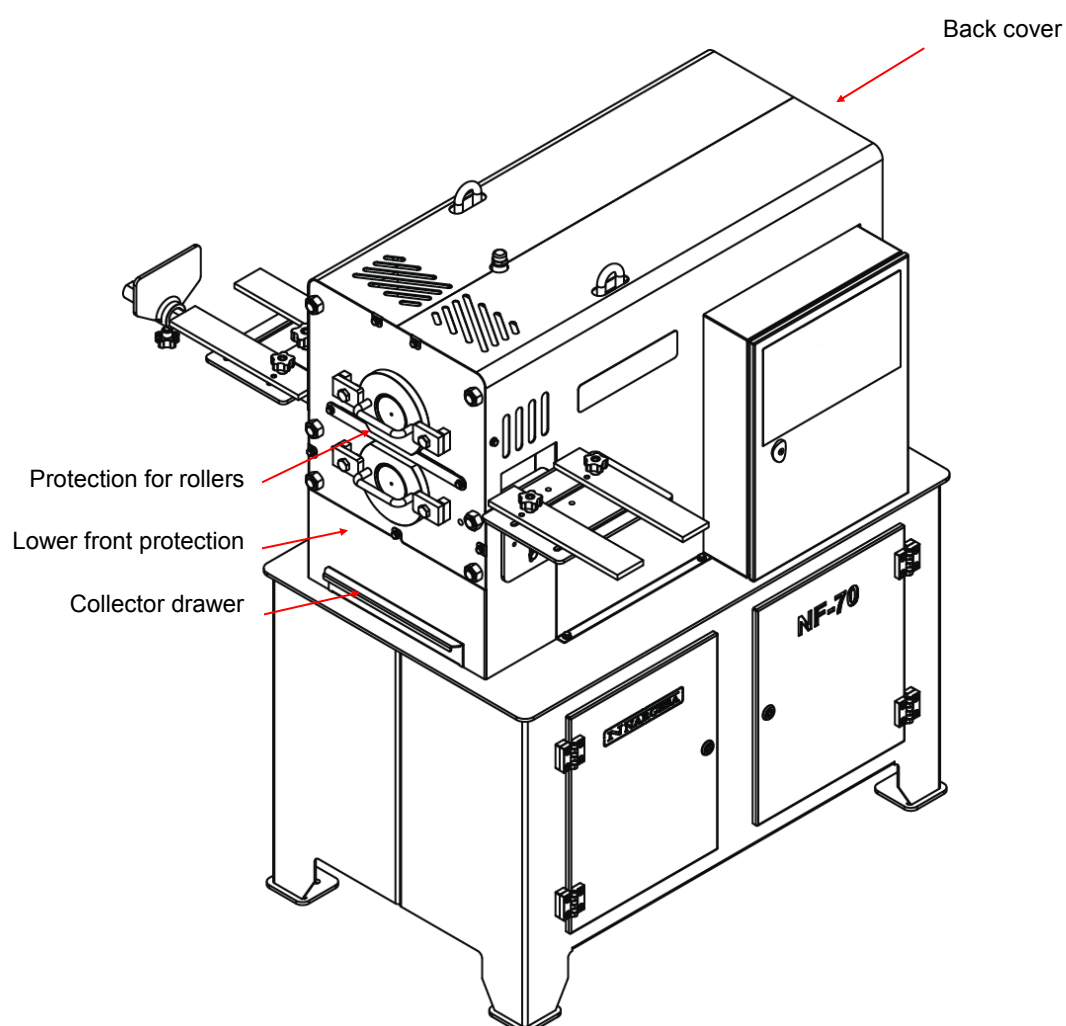

It is ABSOLUTELY FORBIDDEN to work without safety devices of the machine. They will be only cancelled during breakdowns (if necessary) and always with the machine stopped.

2. TRANSPORTATION AND STORAGE

2.1. Transportation

Transportation of the machine is made by a forklift or by shovel, by using the clamping point of the lower base machine (designed for this purpose).

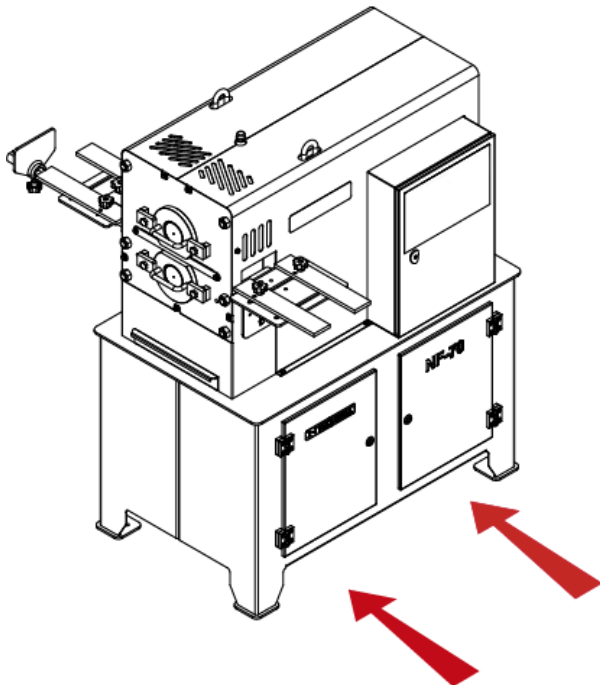

Risk of overturning the machine must be kept in mind.

2.2. Storage conditions

- * Relative humidity between 30% and 95% non-condensing.
- * Temperature 15 ° C and 55 ° C.
- * Do not stack anything on the machine.
- * Do not disassemble the machine for storage.

3. MAINTENANCE AND CLEANING

3.1. General maintenance

The NF70 NARGESA forging machine has been conceived and designed to be almost maintenance free. The only point to note regarding maintenance is the level of lubricant of the gearbox. This level may be observed through the inspection peephole (1) visible in the side of the case, once the rear protection has been disassembled.

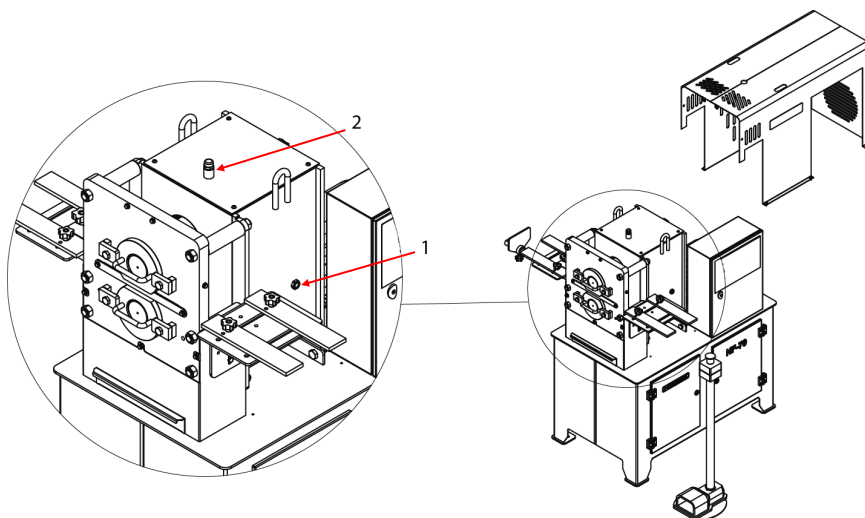

In the event that the level is low, fill it up with oil SAE 80-140 by the filler hole (2) until oil is visible through the peephole (1) (about half of the sight glass). A review of this parameter must be carried out at least once every 3 months.

3.2. Cleaning

The machine NARGESA NF70 is designed to work with hot material (forged), which involves a large amount of slag, chaff, etc is generated. during regular work. For the operator's comfort, the NF70 has a collector drawer at the bottom of the working area, wherein said slag falls, so it is advisable to periodically empty it.

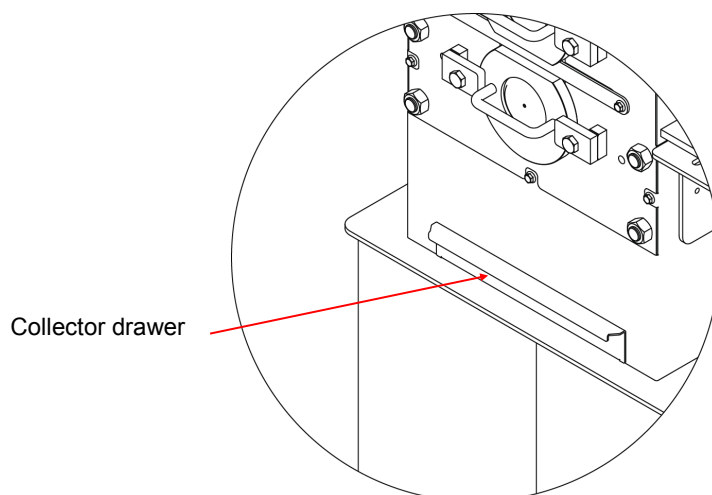

4. INSTALLMENT AND STARTINGUP

4.1. Location of the machine

The NF70 NARGESA machine will be positioned on a flat surface so it can be leveled. If desired, it can be clamped to the ground through the holes made in the base for this purpose.

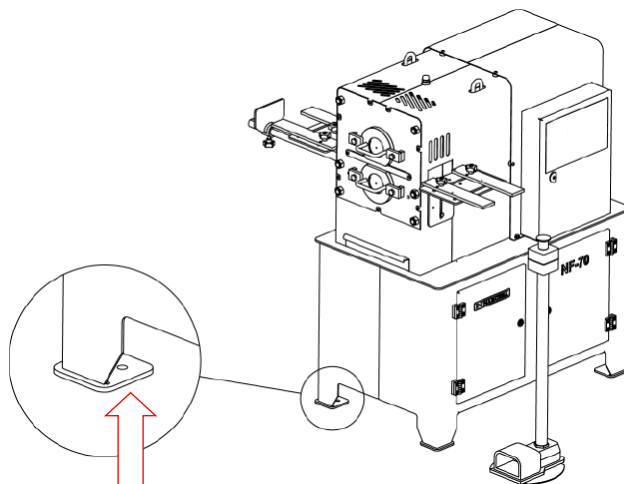

4.2. Working site

To use the forging machine NARGESA NF70 is essential to have enough space to work on the side of it and also have access to the back to carry out the maintenance of the machine.

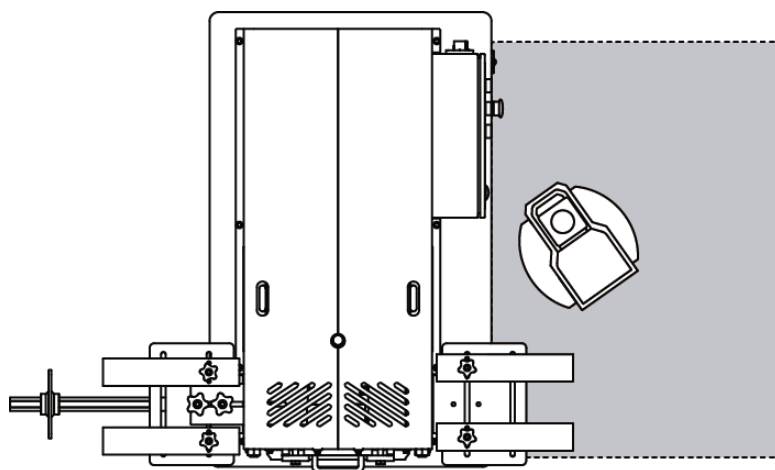

4.3. Admissible outer conditions

The working conditions of the machine NF70 NARGESA ranges between +5 ° C and +50 ° C and the maximum continuous temperature +45 ° C (24 hours)

The condition of humidity ranges between 30% and 90% non-condensing.

4.4. Electric connections

The machine NARGESA NF70 is designed to be connected to an outlet of a three-phase 230 or 400V 50/60Hz

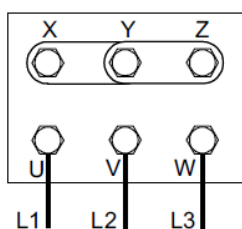

Star shape
(preset)
For tension 400V

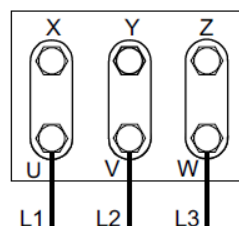

Triangular shape
For tension 230V



NOTE: If voltage changes it will be necessary proceed to drive change, according to the following table.

TENSION	DRIVE TYPE
230 V	SV0551G5A-2
400 V	SV0551G5A-4

5. OPERATIONS

The forging machine NARGESA NF70 has got 2 working modes:

- Manual mode
- Simple mode
- Semi-automatic mode

Before explaining the modes, we'll explain the different components and features of the forging machine NARGESA NF70

5.1. Description of control panel

On the side of the forging machine NF70 NARGESA there is the control panel where the user can identify where the various controls of the machine are located. These controls are located in the following figure.

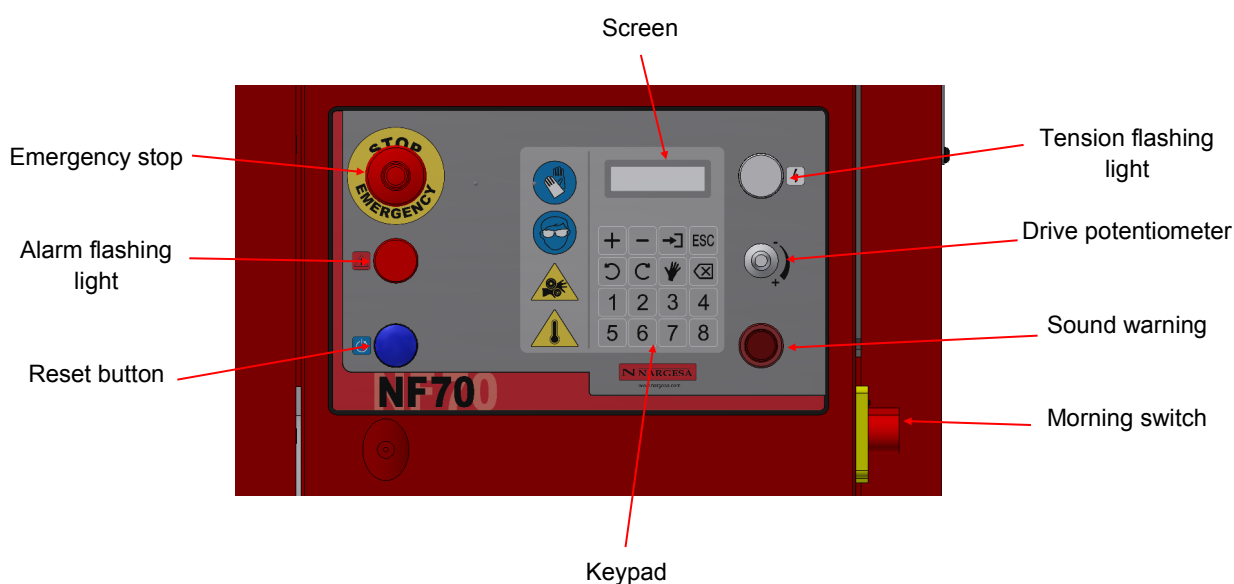

5.1.1. Description of keypad

The functions for each key are detailed below:

- + Key allows us to increase the number of cycles in semi-automatic mode.
- Key allows us to decrease the number of cycles in semi-automatic mode.
-] Key allows us to access the menu to set the number of cycles in semi-automatic mode.
- ESC key allows us to interrupt the programming process that we are currently running.
- Reverse key allows us to turn the rollers in the reverse direction (only during initiation).
- Forward key allows use to turn the rollers in the forward direction (only during initiation).
- Simple mode key allows us to access simple mode.
- Counter key allows us to clear the counter displayed on screen.

Numeric keys allows us to access the semi-automatic mode in each of the 8 memory slots.

Drive potentiometer regulates the speed of the machine

Safety devices reset button

5.1.2. Screen messages

During operation of the machine NARGESA NF70, there will be appearing different messages on the display. We detail here a brief explanation of their meaning:

SELECCIÓN IDIOMA
ESPAÑOL

This is a language selection message. Use numeric keys 1 to 5 to select the language of the messages displayed on screen.

INICIALIZANDO
MEMORIAS...

It will note that the memories are being restarted after the language is changed.

ESCAPE FOR
STARTING

You must press the ESC key to start the machine.

PUSH AND RELEASE
THE FOOT SWITCH

Press the pedal in order to continue.

NF70
STARTING

The machine is running the initiation cycle.

NF70
MANUAL MODE

Manual mode message for NF70. This is the default operating mode.

>>>> SIMPLE MODE
COUNTER: 00000

NF70 simple mode message. The counter increases each time the pedal is pressed.

Define N. Cycles
001

Indicates the number of cycles in semi-automatic mode. We can increase and decrease the number of cycles to run using the + and - keys.

M1 CYCLES: 001
PIECES: 00000

Message in semi-automatic mode on one of the eight available memory slots. The number of parts is increased each time the cycles specified on the screen are completed.

STOP OF
EMERGENCY

One or both of the two emergency stop buttons have been pressed.

5.2. Language selection

The NARGESA NF70 machine has been set up to display messages on the screen in various languages. To change the language, continue with the following procedure:

- Check that the main power switch is in position 0 (OFF).
- Hold down the + key and turn the power switch to position 1 (ON)
- The following message will be displayed on the screen:

SELECCIÓN IDIOMA
ESPAÑOL

- Use the number keys to select the required language. 1 (Spanish), 2 (English), 3 (French), 4 (Italian) or 5 (Polish).
- Press the - key to confirm the changes.

5.3. Initialisation of machine

The NF70 machine needs to be started before operations can begin. The machine should be initiated to ensure that the rollers reach the resting positions so that they can be changed, and also to allow material to be input with the maximum opening.

The procedure to follow is described below:

- Firstly connect the machine to the power socket and make sure that the main switch is in position 0.
- Check that there are no foreign bodies in the roller area (material, loose rollers, etc.).
- Turn the main switch to position I.
- Pull out the emergency stop buttons (if they have been pressed).
- The following message will be displayed on the screen:

STOP OF
EMERGENCY

- Press the blue reset button. The red light will turn off and the message on the screen will change to:

ESCAPE FOR
STARTING

- Press the ESC key and the message on the screen will change again:

PUSH AND RELEASE
THE FOOT SWITCH

- Press and release the pedal. The NF70 machine looks for the initiation point and switches to manual mode by default.

NF70
MANUAL MODE

- The machine stops when the rollers reach the resting position (maximum opening between them).

- Check that the upper roller rotates counter-clockwise. If this is not the case, then you must contact the Nargesa Technical Service.

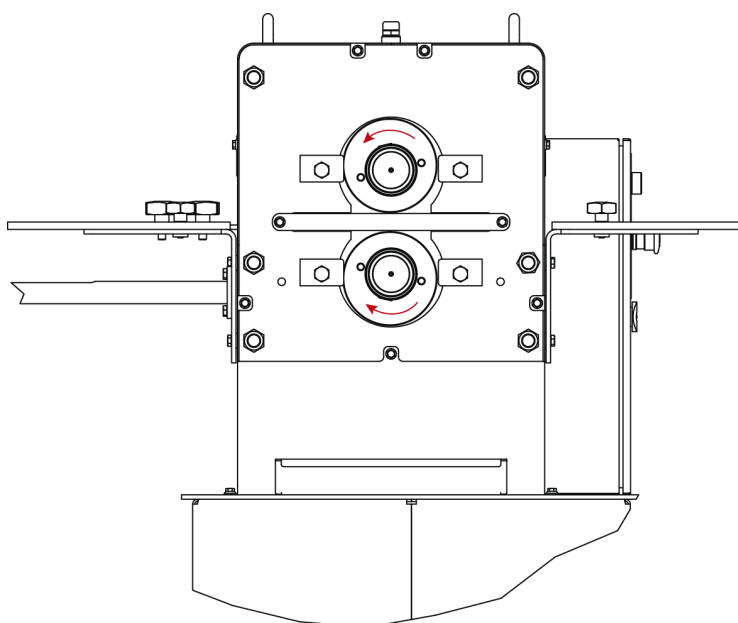

Initiation position and rotation direction

5.4. Change of rollers

As the NARGESA NF70 machine works under mechanical strain and this deformation is done using rollers, the general process to change the rollers is explained below, as this is a common procedure for all.

The machine must be in its starting position in order to change the rollers, otherwise we will have problems when removing them. If the rollers are not in this position, an initiation cycle must be run (see section 5.3).

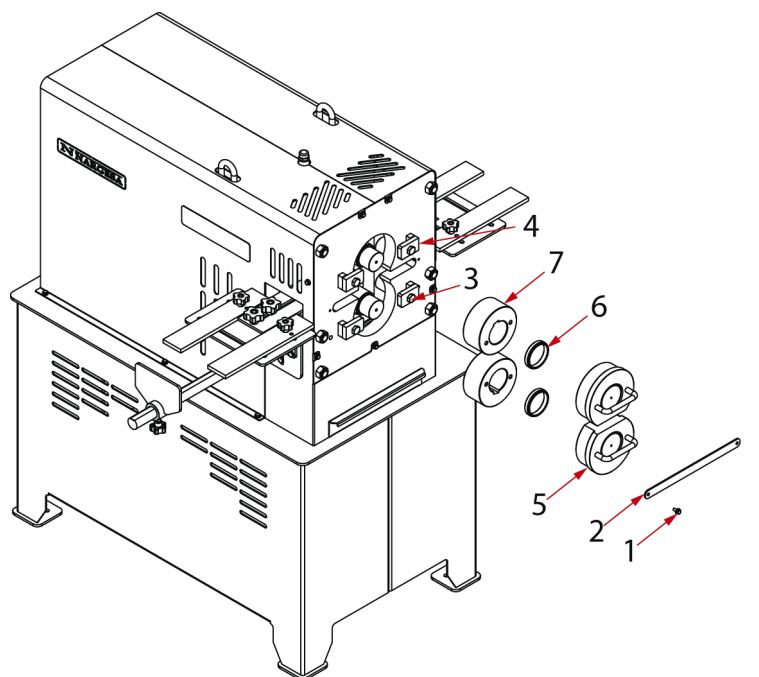

- Press emergency stop.
- We place main switch in position 0
- We loose the screws marked with Nr 1.
- Remove protection on rollers Nr 2
- Aflojamos los 4 tornillos marcados con el Nr 3.
- Turn parts marked with Nr 4 so in order to set parts Nr 5 free.
- Extract parts marked with Nr 5. Keep in mind the position of these parts since they will have to be set in the same position again.
- We'll take out thicks Nr 6, looking after their shape and position.
- We can take out rollers Nr 7.

In order to proceed with assembling it must be done inversely, focussing on the position of parts Nr 6 and Nr 5, fastening well screws Nr3.

5.5. Manual operational mode

The machine needs to be initiated as detailed in section 5.3 before operations in manual mode are started. Manual mode is the machine default operational mode. In this mode, the machine starts to run continuously at a speed set by the potentiometer while we keep pressing the pedal. When the pedal is released, the machine will continue to run until it returns to the starting point, but it will do so at the St3 predefined speed (60Hz).

5.6. Simple mode

The machine needs to be initiated as detailed in section 5.3 before operations in simple mode are started. Press the key with the hand icon to access simple mode. In this operational mode the machine starts to run whenever the pedal is pressed. The working speed is fixed by the potentiometer. When the pedal is released, the machine stops automatically. The screen displays the number of times that the pedal has been pressed. Press the counter key twice to clear the counter.

5.7. Semi-automatic mode

The machine needs to be initiated as detailed in section 5.3 before operations in semi-automatic mode are started. The semi-automatic mode allows us to indicate the specific number of turns or cycles that we want the machine to do. Once complete, the machine will stop and will emit an audible signal. We must remember that we have to keep pressing the pedal to activate the machine. To programme the number of turns, press the →] key and access the menu to define the cycles using the + and - keys. Then, assign the number of defined cycles to one of the 8 existing memory slots by pressing a number key (1 to 8).

The Screen will display a message similar to the one shown below:

M1 CYCLES: 004
PIECES: 00000

Message indicating the we have programmed 4 turns or cycles.

5.8. Unlocking the machine

Due to external causes of the machine, it can be locked, that is to say, the rollers have stopped half cycle and the bar of material has kept in between. This may be due to a lack of heat of the material, inadequate material etc.. The steps to follow in order to unlock the machine are:

- Press the emergency stop button.
- Unlock the emergency stop button and press the reset button so that the following message appears:

ESCAPE FOR
STARTING

or

!!PRECAUTION
PIECE IN MACHINE!!

Now, by pressing the forward and reverse keys we can make the rollers turn at very low speeds to unlock the machine.

This is an emergency situation and care should be taken to avoid injury.

After making an operation of unblocking it will be necessary to startup the machine just as it is described in section 5.3.

5.9. Speed Adjustment

The adjustment speed depends on the load, taking into account that, at maximum load the machine should work at 50 Hz. The working range is 30 Hz to 60 Hz.

6. POSSIBLE FAULTS

Due to normal use of the forging machine NARGESA NF70 abnormal situations could arise, we'll try to describe some below in order to facilitate the use and repair of it.

These anomalies are reflected in the display of the control.

Fault	Cause	Solution
Thermal of motor	Motor overload mainly due to a material without the correct temperature	Heat up material up to 800°C
The rollers do not turn	Fuse F1 at 24 VDC has tripped	Replace F1 fuse with a new one and check that the white light on the control box is turned on.
	There is a problem with the pedal.	Check the pedal and replace it if necessary.
The machine does not initiate properly.	The initiation inductive switch does not detect it.	Adjust the position of the inductive switch and check that it works well.

If the problem goes on, please contact our technical assistance in Nargesa

 +34 972568085
  +34 620446827
  sat2@nargesa.com
  sat2.nargesa

7. WARNINGS

- Do not handle any part of the machine while it is running.
- Do not use the machine for any other purposes but the ones described in this manual.
- Use gloves when handling the machine components and during the working processes.
- Wear safety goggles and homologated protective boots.
- Hold the base material.
- Do not work without the protections devices the machine is equipped with.
- There exist the risk of burns because the base material is at high temperatures.

In case of accident by negligence of the operator, not to follow the safety and operating standards set out in this manual, PRADA NARGESA SL will not take any responsibility.

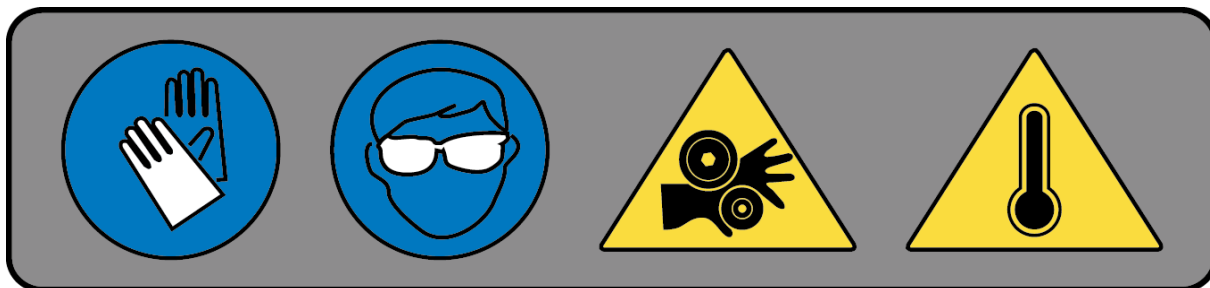

8. DESCRIPTION AND ASSEMBLY OF TOOLING

The NF70 NARGESA machine allows us to perform different forging jobs such as:

- Tips on the end.
- Estriated tail fish end on flat bars.
- Marking the middle of the bar.

For each kind of job it is require to use different type of rolls and different caps. The following sections explain what type of rollers and buffers are needed for each job.

8.1. Points at the end extreme

The maximum capacity for points at the end of the profile is the mild steel square of 20x20mm.

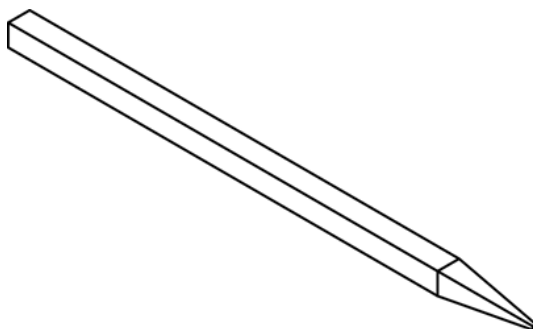

8.1.1. Description of elements

To make the tips at the end, we will need the following parts:

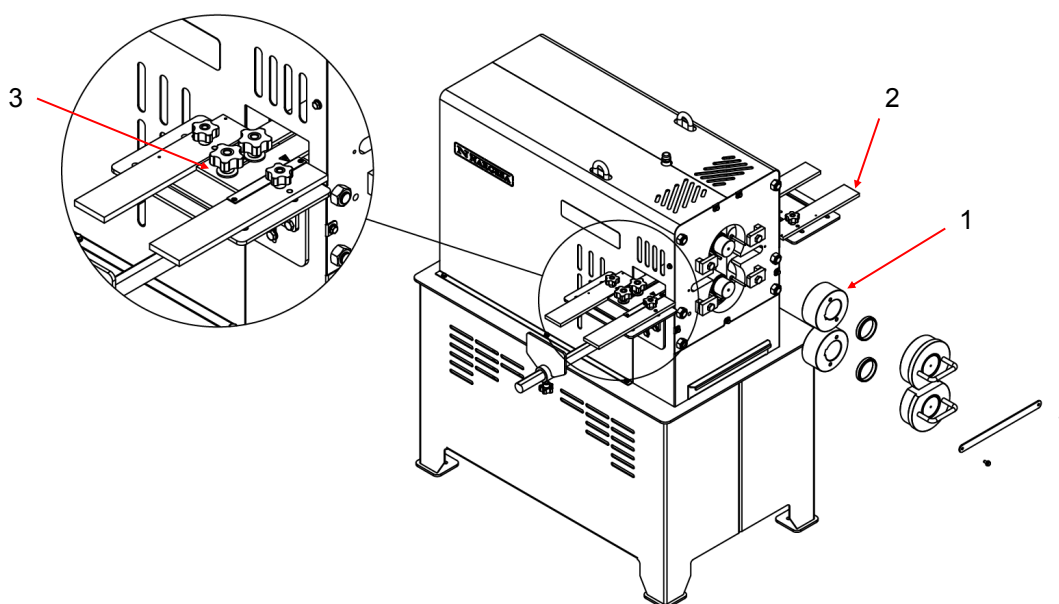

- | | |
|---------------------------|---------|
| 1. Eccentric flat rollers | 2 units |
| 2. Inlet guides | 2 units |
| 3. Stop | 1 units |

We set the rollers (1) as explained in section 5.4. we also assemble the inlet guides (2) and stop (3). If we set the rollers (1) on the outside of the machine, the inlet guides will locate in such position that we can center the material on the roller (1). In order to do this we'll loosen the knobs that secure the guide and move it.

On the other side, we position the stop (3), so that we obtain the desired length of the tip. This position is determined from the user's personal experience and the desired shape of the tip. The furthest the stop is from the rollers, the thinner the tip will be; conversely, if the stop is closer to the rollers, this tip will be thicker.

Since smooth eccentric rollers are tight, the user must place another narrow rear roller to axially fix them.

8.1.2 . Working procedure

For proper implementation of the tips we recommend do it in different passes, it means it will take more than one cycle to make them.

It is recommended that each time you make a pass rotated 90° to the material, as in this way the execution of the tip is more uniform. The number of passes required depends on each user.

Recall that the work must be always done with the material hot.

WARNING: Note that once the piece is ready, it may be very hot with the risk of burns, so let the piece cool out at air temperature.

8.2. Fish tail ends

Fishtail end is usually made on rectangular flat bar. The maximum capacity of the forging machine Nargesa NF70 for a flat bar is 40x10mm, although it can be also obtained from a square bar (20x20mm as maximum Cap.)

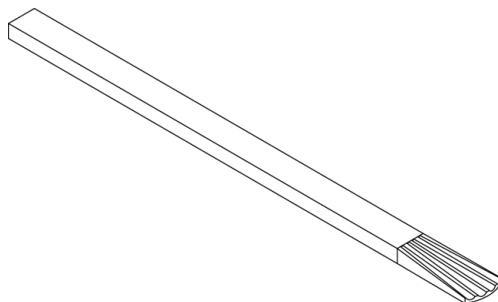

8.2.1. Description of elements

In order to make the fishtail ends we'll need the following parts:

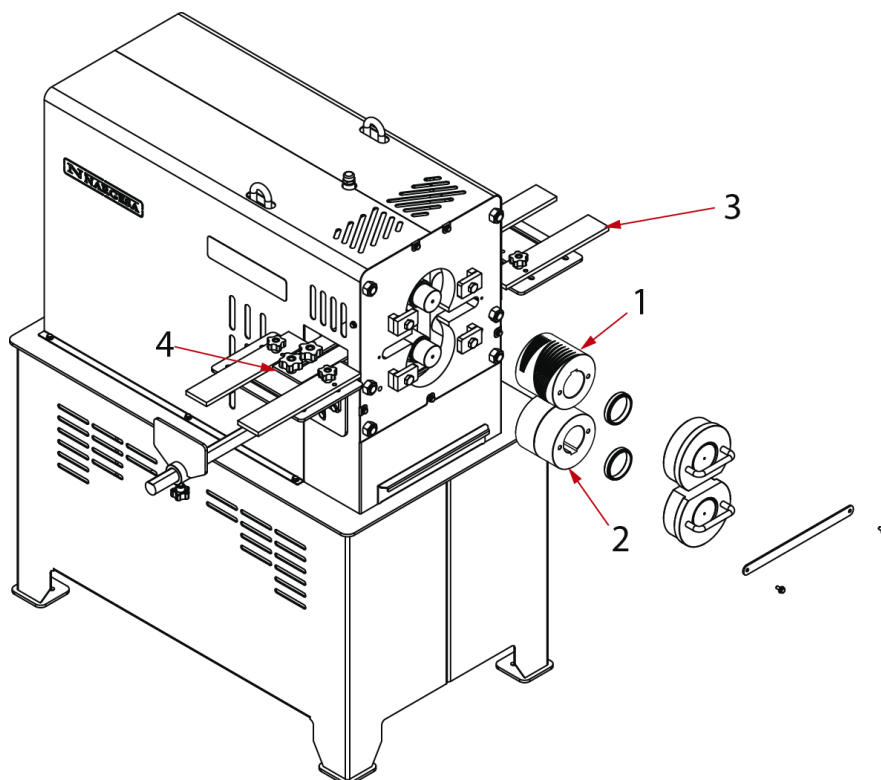

1. Fishtail roller	1 unit
2. Eccentric flat roller	2 units
3. Inlet guide	2 units
4. Stop	1 unit

We set the roller (1) and (2) as explained in section 5.4. we also assemble the inlet guide (3) and the stop (4).

As it can be seen, the fishtail roller (1) has got 2 sizes depending on the striated finish we want to obtain.

8.2.2. Working procedure

Once we know what kind of striated we wish to do and knowing that this depends on the roller, we move the inlet guide (3) so that the material to forge remains either to the left (large striated) or to the right (small striated). The flat bar should be centered in order to forge with the desired roller.

We graduate the stop (4) which will indicate the length of the fish tail. Place the material in the oven and when it is red hot then proceed to the execution of the fishtail tip.

The difference relative to the tip we described in the previous section is that the fish tail tip is performed in a single pass.

WARNING: Note that once the piece is ready, it may be very hot with the risk of burns, so let the piece cool out at air temperature.

8.3. Marking on the middle part of the bar

It is possible to make different kinds of marking in the middle part of the bar, such as:

- Flat marking
- Trilobular marking

The marking in the middle of the bar is usually performed on square bar and the maximum capacity of the forging machine NARGESA NF70 is mild steel square of 20x20mm.

8.3.1. Flat marking

Within the marked-up we have three variants that are made with the same rollers, depending on whether you work in the front, middle or back of the roll.

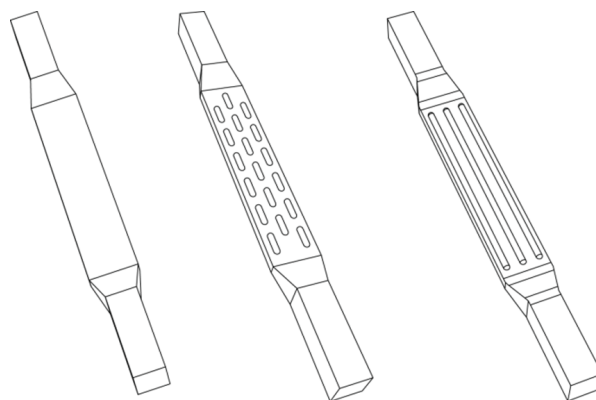

8.3.1.1. Description of elements

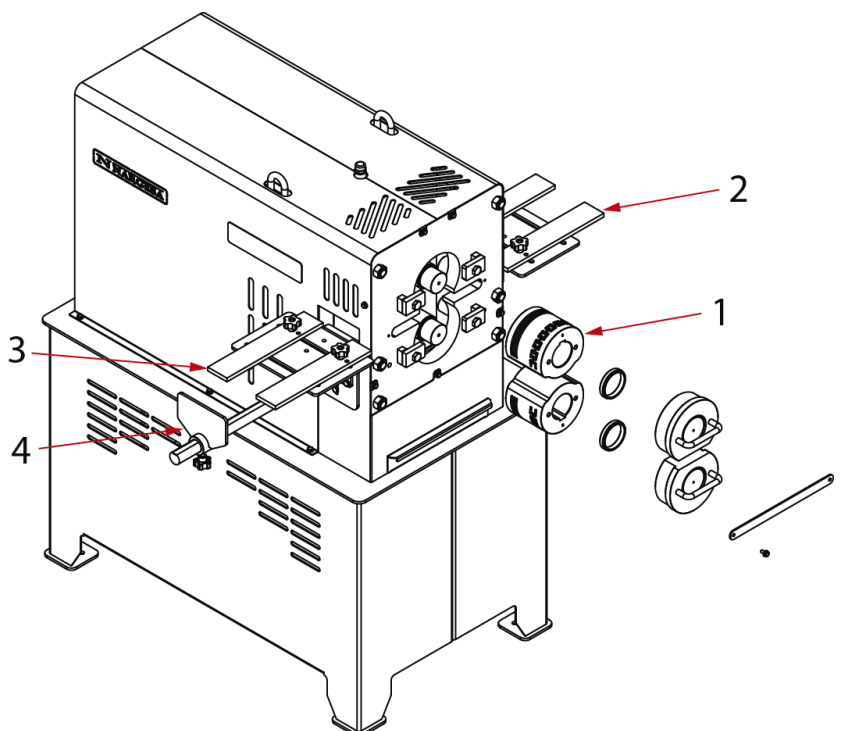

In order to make flat marking we will need the following parts:

- | | |
|--|---------|
| 1. Intermediate triple marking rollers | 2 units |
| 2. Inlet guide | 2 units |
| 3. Outlet guide | 2 units |
| 4. Back stop | 1 units |

We set the roller (1) as explained in section 5.4, keeping in mind to match the upper roller drawings with the bottom roller drawings. We set the inlet guides (2), the outlet guides (3) and the rear end position (4). As it can be seen, the intermediate roll marking has 3 three working areas. We'll place the inlet guide and the output guide in such way that they center the material with the marking we want. The backstop will set the position where we want to do the marking.

8.3.1.2 . Working procedure

Heat up the material until it is red hot in the area where we want to make the flat marked.

We graduate the back stop (4) in order to indicate the starting point of the area to be marked. Once we have the material ready, we insert it through the the guides 'til it reaches the stop and then we activate the pedal once. The machine starts up and it marks the material by dragging the material to the entrance area. The marking is ready.

WARNING: Note that once the piece is ready, it may be very hot with the risk of burns, so let the piece cool out at air temperature.

8.3.2. Trilobular marking

The trilobular marking is a variant of the marking in the middle part of the bar which differs from the flat marking by the type of roller it is made with.

The maximum capacity admitted is 20x20mm square bar on mild steel.



8.3.2.1. Description of elements

In order to make the trilobular marking we will need the following parts:

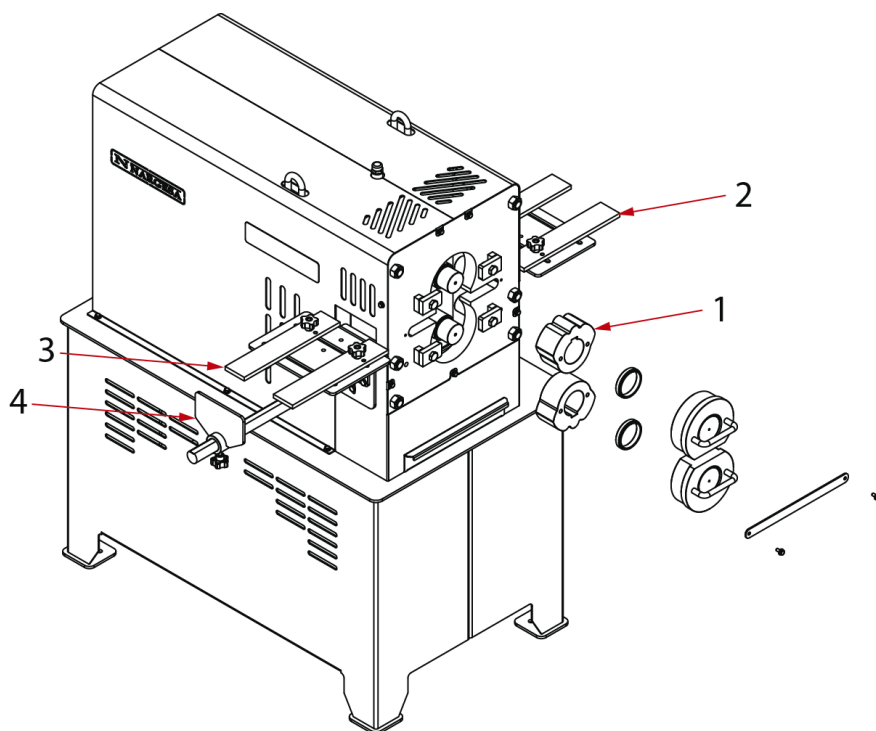

1. Trilobular rollers	2 units
2. Inlet guides	2 units
3. Outlet guides	2 units
4. Back stop	1 units

We set the roller (1) as explained in section 5.4, bearing in mind to match the upper roller drawings with the bottom ones. We set the inlet guides (2), the outlet guides (3) and the rear end position (4). Since the trilobular rollers are narrow we need to place another narrow rear roller to fix it axially.

8.3.2.2. Working procedure

Heat up the material until it is red hot in the area where we want to make the flat marked.

We graduate the back stop (4) so it indicate the starting part of the área to be marked.

Once we have the material ready, we insert it through the guides until it reaches the stop and then we press the pedal once. The machine starts up and it marks the material by dragging it to the entrance area.

The marking is ready.

WARNING: Note that once the piece is ready, it may be very hot with the risk of burns, so let the piece cool out at air temperature.

9. TOOLING

9.1. Standard tooling

Set of flat rollers

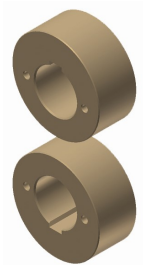

Set of flat rollers to make flat and piramidal extremes.



Set of striated rollers

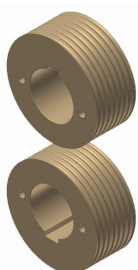

Set of striated rollers to get fishtail shaped ends.



9.2. Optional tooling

Set of trilobular rollers

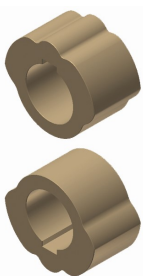

Set of trilobular rollers to emboss decoration in the middle of a baluster.

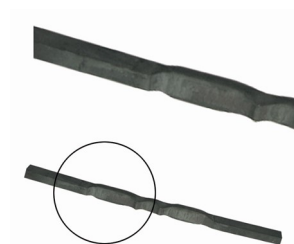

Set of triple middle marking rollers

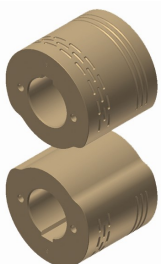

Set of excentric rollers to emboss the middle of balusters. Triple design, flat, striped and discontinuous in the same roller.

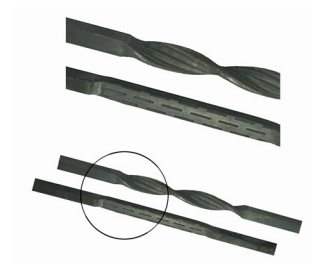

Set of fishtail roller

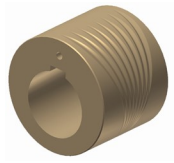

Two-grooved roller, one for big diameters and the other one for smaller diameters.



Set of special rollers

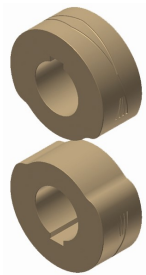

We design and manufacture all kind of special rollers under request.

Technical annex







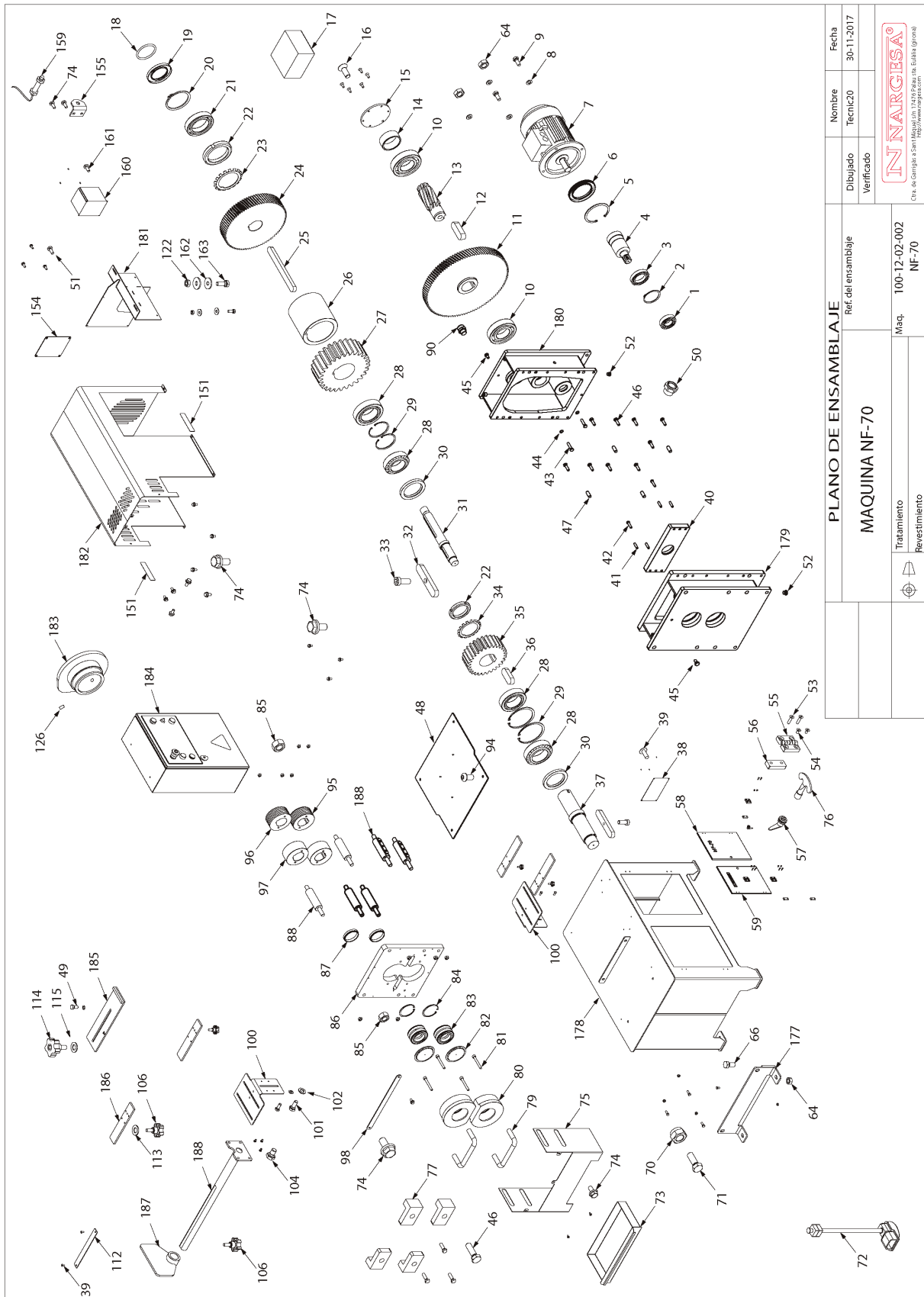













End wrought iron machine NF70



















List of parts
Electric maps

A1. List of parts







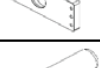



































PLANO DE ENSAMBLAJE		Nombre	Fecha
Ref. del ensamble		Técnic20	30-11-2017
MAQUINA NF-70		Dibujado	Verificado
Tratamiento		Maq.	100-12-02-002
Revestimiento		NF-70	
			
C/ta. Al Compañía s San Miguel (Ch. 17019) Pinar (ta. Cuba) (Grono) info@www.nargesa.com			
Este plano es propiedad de Pinar Nargesa S.L. No podrá ser reproducido, comunicado a terceros o utilizado para la fabricación sin la permitividad.			

















ELEMENTO	DIBUJO	DESCRIPCION	REFERENCIA	CANTIDAD
1		030-CI-00017	COJINETE DE RODILLOS NI206 30X62X16	1
2		030-D471-00012	ANILLO ELASTICO PARA EJE DIN471 D60X2	1
3		030-CI-00010	COJINETE DE BOLAS 6012 D60XD95X18	1
4		120-12-02-00017	PIÑON DE ENTRADA MOTOR	1
5		030-D472-00013	ANILLO ELASTICO PARA AGUJERO DIN472 D95X3	1
6		040-RET-00006	RETEN D65XD95X10	1
7		050-ME-00010	Motor Electrico de 5.5 Kw A 1400 rpm Brida B5	1
8		020-D125B-M12	ARANDELA BISELADA DIN125 M12	4
9		020-D933-M12X30	TORNILLO HEXAGONAL DIN933 M12X30	2
10		030-CI-00013	COJINETE DE BOLAS 6207 D35XD72X17	2
11		120-12-02-00109	ENGRANAJE 1	1
12		030-D6885A-00024	CHAVETA DIN6885 A 10X8X32	1
13		120-12-02-00110	PIÑON 2	1
14		120-12-02-00136	SEPARADOR COJINETE	1
15		120-12-02-00134	TAPETA COJINETE INFERIOR	1
16		020-D7991-M6X20	TORNILLO ALLEN DIN7991 M6X20	6
17		060-BA-00010	VALVULINA SAE 85-140	15
18		040-JT-00029	JUNTA TORICA D34x3 90 SHORE	1
19		040-RET-00002	RETEN D50XD80X8	1
20		030-D471-00011	ANILLO ELASTICO PARA EJE DIN471 D50	1

ELEMENTO	DIBUJO	DESCRIPCION	REFERENCIA	CANTIDAD
21		030-CJ-00009	COJINETE DE BOLAS 6010 D50XD80XD16	1
22		020-D981-KM12	TUERCA RANURADA DIN981 M60x2 KM12	2
24		120-12-02-00111	ENGRANAJE 2	1
25		030-D6885A-00025	CHAVETA DIN6885 A 18X11X180	1
26		120-12-02-00135	CASQUILLO SEPARADOR 2	1
27		120-12-02-00112	ENGRANAJE SUPERIOR REENVIO	1
28		030-CJ-00006	COJINETE DE RODILLOS CONICOS 33112 60x100x30	4
29		030-D472-00011	ANILLO ELASTICO PARA AGUJERO DIN472 D100x3	4
30		040-RET-00007	RETEN D70XD100X10	2
31		120-12-02-00204	EJE MOTRIZ SUPERIOR	1
32		120-12-02-00153	CHAVETA RODILLOS (030-DIN6885A-18X11X100)	2
33		020-D6912-M6X16	TORNILLO ALLEN DIN6912 M6X16	2
34		120-12-02-00191	ARANDELA FIJACION TUERCA KM-12 EJE INFERIOR	2
35		120-12-02-00113	ENGRANAJE INFERIOR REENVIO	1
36		030-D6885AB-00006	CHAVETA DIN6885 AB 18X11X47	1
37		120-12-02-00203	EJE MOTRIZ INFERIOR	1
38		122-PLC-0000-001	PLACA CARACTERISTICAS GENERAL	1
39		020-D7337-3X8	REMACHE DE CLAVO DIN7337 D3X8	7
40		120-11-01-00415	SOPORTE CENTRAL REDUCTOR	1
41		030-D7979D-00004	PASADOR CILINDRICO DIN 7979D D8X30	4

ELEMENTO	DIBUJO	DESCRIPCION	REFERENCIA	CANTIDAD
42		020-D6912-M8X30	TORNILLO ALLEN DIN 6912 M8X30	2
43		020-D933-M12X50	TORNILLO HEXAGONAL DIN 933 M12X50	2
44		040-JMG-00002	JUNTA METAL GOMA 1/4"	2
45		020-D933-M12X20	TORNILLO HEXAGONAL DIN 933 M12X20	2
46		020-D933-M12x40	TORNILLO HEXAGONAL DIN 933 M12X40	13
47		030-D7979D-00020	PASADOR CILINDRICO DIN 7979D D16X40	4
48		120-11-01-00416	TAPA REDUCTOR	1
49		020-D933-M10X20	TORNILLO HEXAGONAL DIN 933 M10X20	1
50		040-NA-00001	NIVEL DE ACEITE 3/8" GAS	1
51		020-I7380-M6X6	TORNILLO ALLEN ISO 7380 M6X6	4
52		040-TVA-00004	TAPON DE VACIADO ALLEN 3/8" GAS	2
53		020-D7991-M6X25	TORNILLO ALLEN DIN7991 M6X25	8
54		020-D7991-M6X12	TORNILLO ALLEN DIN7991 M6x12	8
55		031-BP-00001	BISAGRA DE PLASTICO 30 ENTRE CENTROS	4
56		120-12-02-00125	GRUESO PUERTA	4
57		031-CLT-00001	CIERRE DE LENGÜETA CON TRIANGULO 8 M20	2
58		120-12-02-00142	PUERTA DERECHA	1
59		120-12-02-00143	PUERTA IZQUIERDA	1
64		020-D934-M12	TUERCA DIN934 M12	4
66		020-D933-M12X25	TORNILLO HEXAGONAL DIN933 M12X25	2

ELEMENTO	DIBUJO	DESCRIPCION	REFERENCIA	CANTIDAD
70		020-D934-M14	TUERCA DIN 934 M14	4
71		020-D933-M14X40	TORNILLO HEXAGONAL DIN933 M14X40	4
72		050-PED-002	PEDAL SIMPLE CON PARO DE EMERGENCIA	1
73		120-12-02-00152	CAJON RECOGEDOR NF70	1
74		020-D6921-M6X12	TORNILLO HEXAGONAL EMBRIDADO M6X12 8.8 PAVONADO	21
75		120-12-02-00141	TAPA INFERIOR	1
76		031-LLT-00001	LLAVE PARA CIERRE TRIANGULO DE 8 FLOTANTE NIQUELADA	1
77		120-12-02-00211	OREJA SUJECCION NF70	4
79		120-12-02-00171	ASA BUJE DELANTERO	2
80		120-12-02-00138	SOPORTE COJINETES DELANTEROS	2
81		020-D912-M6X50	TORNILLO ALLEN DIN912 M6X50 PAVONADO	4
82		120-12-02-00139	TAPA COJINETE EXTERIOR	2
83		030-CJ-00018	COJINETE RODILLOS DOBLE D50XD80X40 SL045010PP	2
84		030-D472-00012	CIRCLIP DIN472 AGUJERO D80	2
85		020-D934-M18	TUERCA HEXAGONAL DIN934 M18	12
86		120-12-02-00210	PLACA DELANTERA	1
87		120-12-02-00137	CASQUILLO SEPARADOR RODILLOS	2
88		120-12-02-00105	VARILLA SEPARADORA	2
90		040-TRE-00001	TAPON RESPIRADERO 3/8"	1
94		020-I7380-M6X12	TORNILLO ALLEN ISO 7380 M6X12	4

ELEMENTO	DIBUJO	DESCRIPCION	REFERENCIA	CANTIDAD
95		125-12-02-00007	RODILLO AFOAT INFERIOR NF70-2	1
96		125-12-02-00006	RODILLO AFOAT SUPERIOR NF70-2	1
97		125-12-02-00001	RODILLO EXCENTRICO LISO NF70	2
98		120-12-02-00166	PROTECCION REGATA DELANTERA	1
100		120-12-02-00146	SOPORTE GUIA ENTRADA	2
101		020-D933-M8X20	TORNILLO HEXAGONAL DIN933 M8X20	4
102		020-D125B-M8	ARANDELA DIN125 B M8	4
104		020-D933-M8X10	TORNILLO HEXAGONAL DIN933 M8X10	4
106		031-POMM-00009	POMO MACHO ESTRELLA MATE D44 M8X15	5
112		120-08-02-00072	REGLA ALUMINIO MC-200	1
113		020-D9021-M8	ARANDELA DIN 9021 M8 PAVONADA	4
114		031-POMM-00008	POMO ESTRELLA MATE MACHO D44 M10X20	1
115		020-D9021-M10	ARANDELA DIN9021 M10	2
122		020-D934-M6	TUERCA DIN934 M6	2
126		020-D913-M6X12	ESPARRAGO ALLEN DIN913 M6X12	1
151		122-CAL-1501-002	ADVERTENCIAS PC-16	2
154		120-12-02-00201	TAPA TRASERA VARIADOR DE FRECUENCIA	1
155		120-12-02-00202	SOPORTE INDUCTIVO M8	1
159		050-IND-M8	INDUCTIVO M8	1
160		050-VF-00010	VARIADOR FRECUENCIA SV055iG5A-4	1

ELEMENTO	DIBUJO	DESCRIPCION	REFERENCIA	CANTIDAD
161		020-D7985-M4X10	TORNILLO DIN 7985 M4X10 PHILIPS	4
162		020-D9021-M6	ARANDELA DIN9021 M6	4
163		020-D933-M6X16	TORNILLO HEXAGONAL DIN 933 M6X16	2
177		130-12-02-00216	SOPORTE FRONTAL CARCASA REDUCTOR	1
178		130-12-02-00200	CONJUNTO ESTRUCTURA NF-70	1
179		130-11-01-00321	CARCASA REDUCTOR LADO MAQUINA	1
180		130-11-01-00322	CARCASA REDUCTOR LADO MOTOR	1
181		130-12-02-00220	CONJUNTO SOLDADO SOPORTE VARIADOR	1
182		130-12-02-00224	TAPA PRINCIPAL NF-70	1
183		130-12-02-00222	CONJUNTO EXCENTRICA NF-70	1
184		050-KIE-1202-002	KIT ELECTRICO NF-70	1
185		130-12-02-00218	CONJUNTO TOPE PUNTAS	1
186		130-12-02-00223	CONJUNTO GUIA ENTRADA	4
187		130-12-02-00207	CONJUNTO TOPE	1
188		130-12-02-00206	CONJUNTO GUIA TOPE	1
189		130-12-02-00219	CONJUNTO SOLDADO VARILLA SEPARACION INFERIOR	4

A2. Electric maps

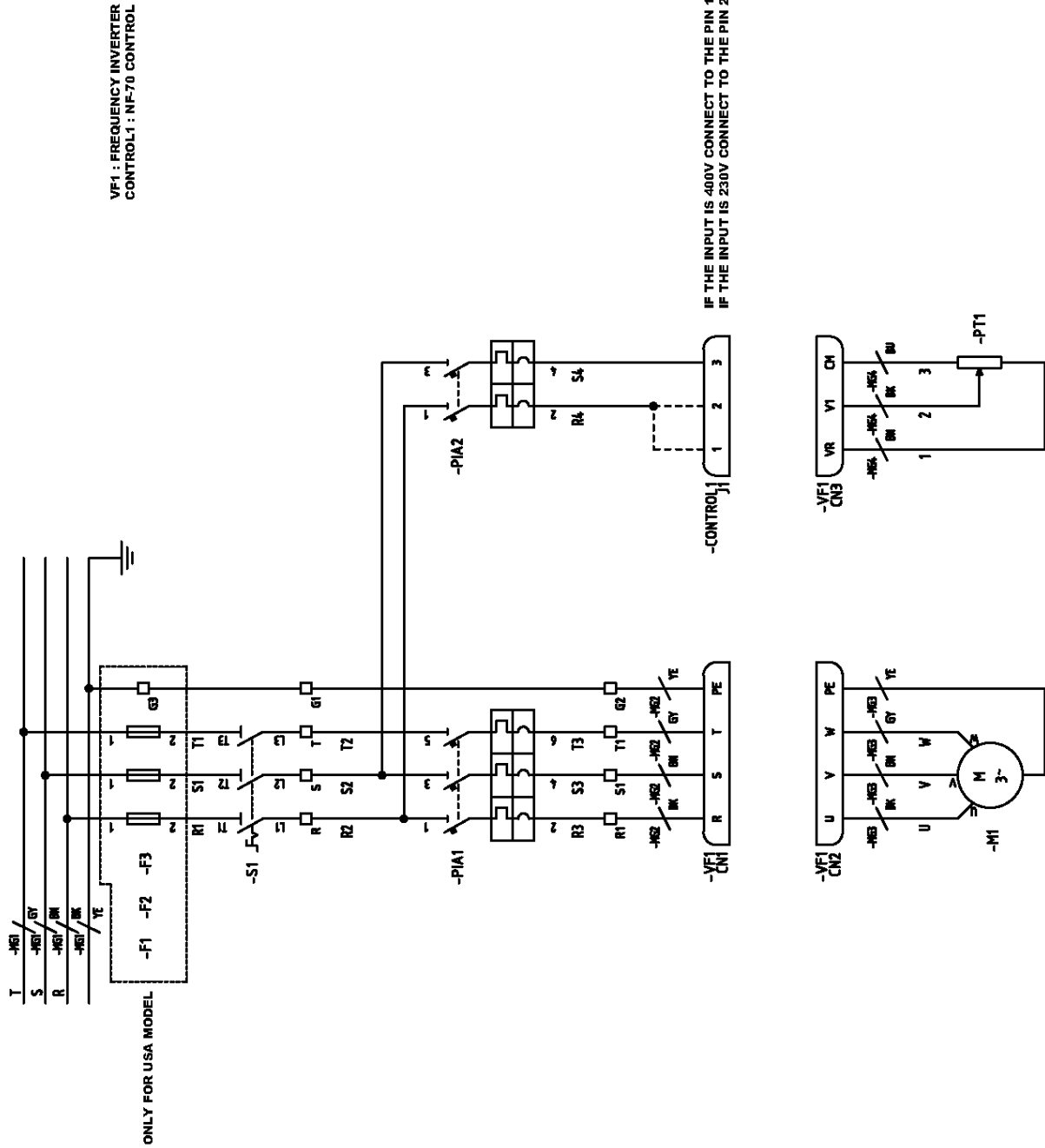

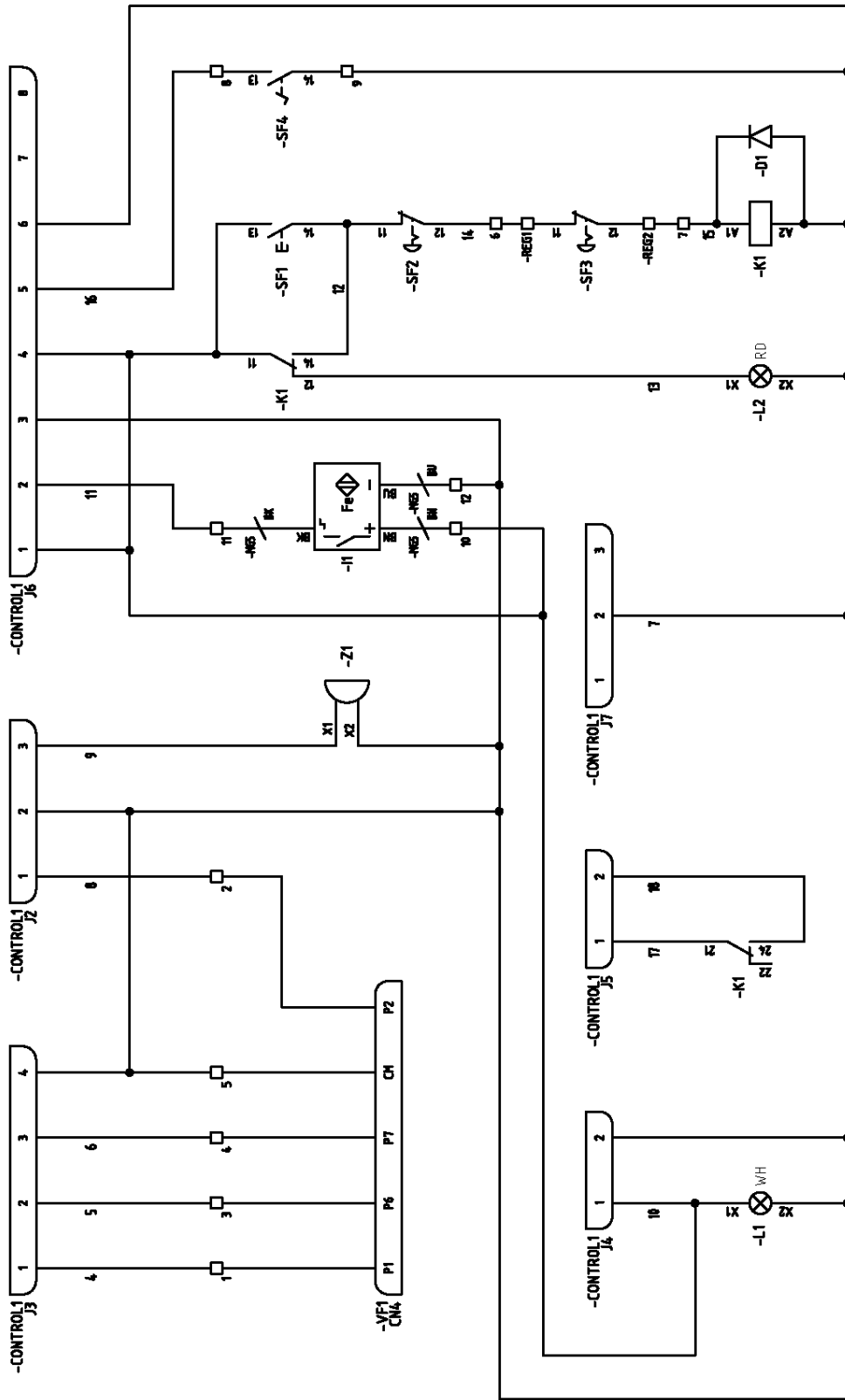

- CONTROL1 : NF-70 CONTROL
- VF1 : FREQUENCY INVERTER
- Z1 : END CYCLE BUZZER
- H : CYCLE INDUCTIVE
- SF1 : RESTART BUTTON
- SF2 : FRONT EMERGENCY STOP
- SF3 : PEDAL EMERGENCY STOP
- SF4 : PEDAL
- L1 : ON LAMP
- L2 : ERROR LAMP

WARRANTY REGISTRATION

1. Among www.nargesa.com on our site
2. Select the menu [Warranty Registration](#)

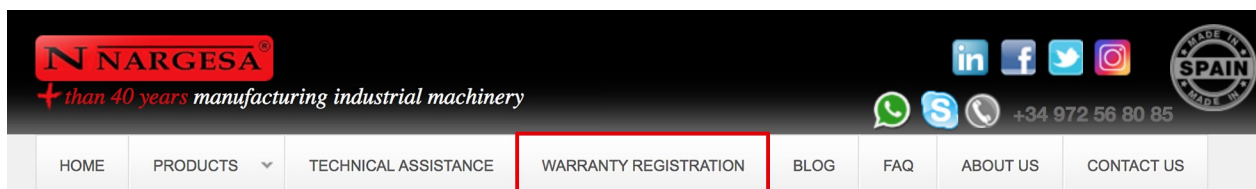

3. Complete the form with your details and press

Submit

4. **Message Sent:** confirms your data has been successfully sent to Prada Nargesa SL. Your machine has been registered and has a warranty of three years in total.

Your request has been sent correctly. We will contact you right away to confirm that your warranty has been extended up to three years