

N NARGESA®

VERTICAL BROACHING MACHINE

BM25



50 years
manufacturing industrial machinery

VERTICAL BROACHING MACHINE

The Hydraulic Broaching machines BM25 NARGESA is a machine to make notches or keyways in all kind of pieces: sprockets, pulleys, gears, bearings...

REQUEST QUOTATION

Please complete the following form. We'll contact you in less than 24 hours.
Business days

VIDEO MACHINE OPERATION

Machine performance video

SOME OF OUR REMARKABLE CUSTOMERS



VERTICAL BROACHING MACHINE

Hydraulic Broaching machine BM25 Nargesa has been fabricated in a welded and mechanized steel monoblock. BM25 has been thought for small medium productions. By medium production we mean less than 350 units.



Versatility

It's used for making small and big pieces. All kinds of broaching and different tolerances. 2 mm keyways from 2 up to 25 mm or 1" inch.

It is also used like a press to unbolt oxidated parts, assembling and dismantling bearings...



Reliability

Because of its use, the keyway is always made with the required tolerance and parallelism.



Easy use

Anyone can make a keyway, there's no need to be a skilful operative.



Fast setting up

The preparation time of the machine before making a broaching operation is approximately 1 min.



Effectiveness

The machine can be moved easily next to a lathe or machining center. While those machines work, the same operative can make the broaching operation.

TECHNICAL FEATURES

Hydraulic Broaching machine BM25 is supplied as standard with the following components:

Structure

- > Mechanized single-block bench
- > Lower bench palletized to move the machine easily to the working site or storage.
- > LED front lightning.
- > Manual operation for a better broaching control.
- > Low noise level which improves the working quality of the operator.
- > Front polycarbonate protection that allows to see the broaching process.
- > Front opening with safety hinges.
- > Tooling supplied as standard for the positioning of the parts. This tool is adjusted and fixed to the work bench in the exact position so that the broaching piece is placed easily and quickly in its correct position. There is no need to hold the piece.
- > Hydraulic oil CEPSA HYDRAULIC HM 68

Broaches

- > The broaches we offer are one of the best trademarks in the market, internationally speaking.
- > They are manufactured under strict quality controls, guaranteeing the higher liability and durability.
- > Made in the USA.
- > Some shims are provided with each broach, the ones used for accomplishing the required tolerance.
- > Broaches in millimetres and inches.
- > Broaches of different kinds and tolerances: ISO J-9, ISO P-9.

Control panel

- > The control panel is very intuitive and easy to use.
- > It includes the conversion chart from pressure to tons.
- > Broaching pressure regulator with pressure manometer.

Safety

- > The Broaching machine BM25 incorporates all safety devices according to CE regulations.

** All our products are manufactured in our facilities in Spain. Hydraulic and electronic components are completely standard from the best European leading trademarks, with technical support all over the world: Rexroth, Bosch, Roquet, Schneider Electric, LG, Telemecanique, Pizzato...*

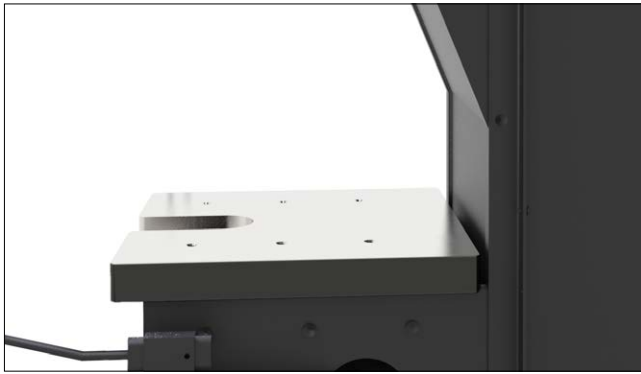

Neck

The 300mm neck allows to broach pieces up to 600mm in diameter, without any problem.



Front polycarbonate guards

The two front doors incorporate polycarbonate windows so that the operator can control the broaching process at all times, in total safety.



Lighting on the broaching table

It is very important to count on a proper lighting inside the broaching cabin, so the operator can control the whole broaching process.



Drawer for chips collection

The machine has a drawer where all the chip that is generated during the broaching process is collected. This is a removable drawer which can be easily emptied.



Pressure regulator

By using the pressure regulator and the pressure manometer installed in the machine, we can adjust the working pressure so that it is the ideal one for each broaching operation.

The Broaching machine
BM25 is not only
capable of making slots
for keyways (notches),
but also **polygonal
shapes** from
cylindrical holes:
squares, rectangles,
hexagons...

It is also possible to
make a given number
of slots from the same
hole and even getting
to generate
inner grooves

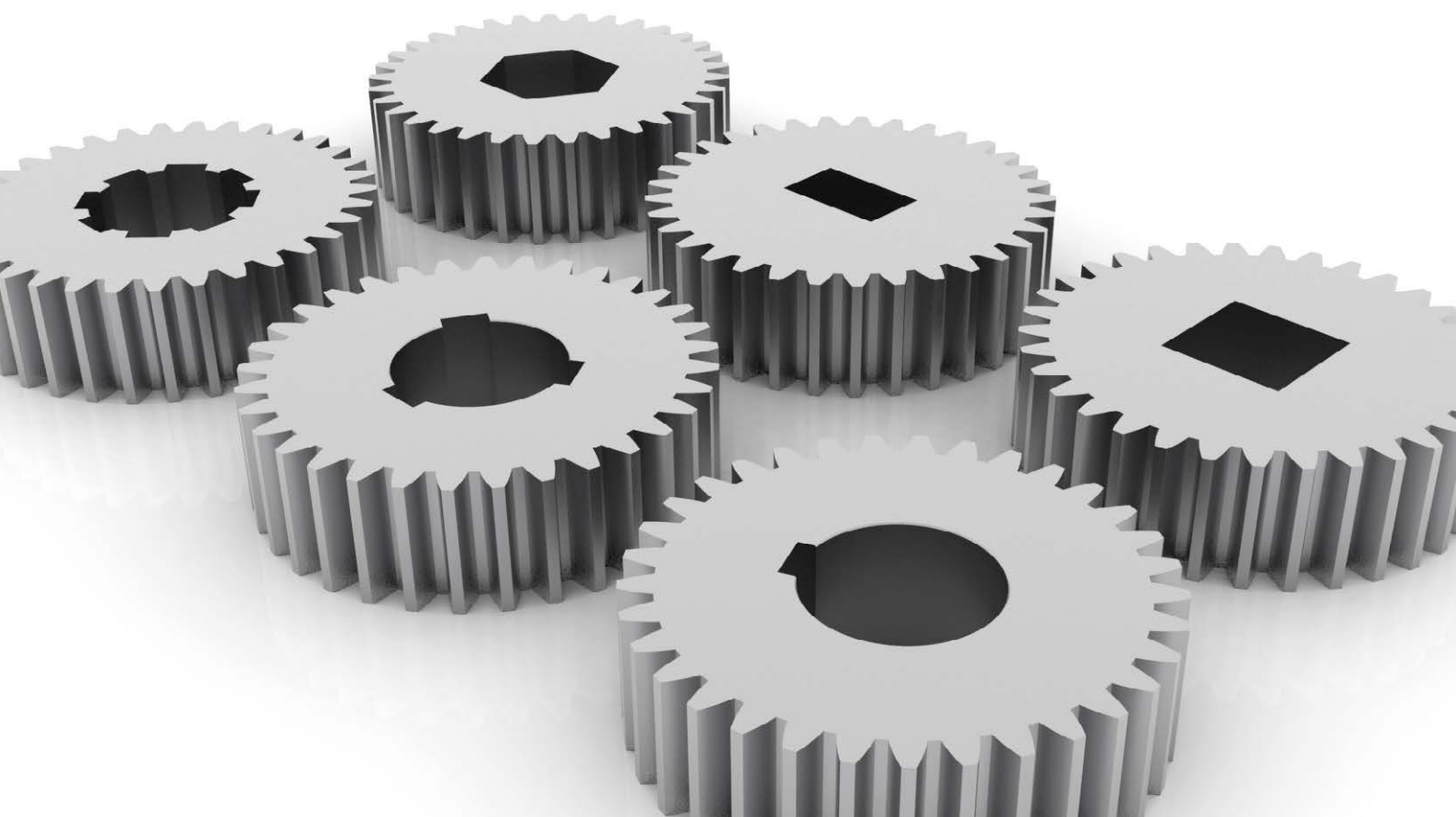

DETAILED FEATURES



Motor power

2,2 Kw / 3 Hp.



3-phased tension

230/400 V.



Hydraulic power

10 Tn.



Max. broaching capacity

25 mm.



Working speed

24 mm/s.



Return speed

54 mm/s.



Pump Flow

7,5 liters



Capacity of Hydraulic Tank

25 liters



Shank displacement

600 mm.



Gooseneck

300 mm.



Max. piece diameter

600 mm

(For different sizes, please ask the manufacturer)



Bench dimensions

420 mm x 420 mm.

EXTERNAL DIMENSIONS

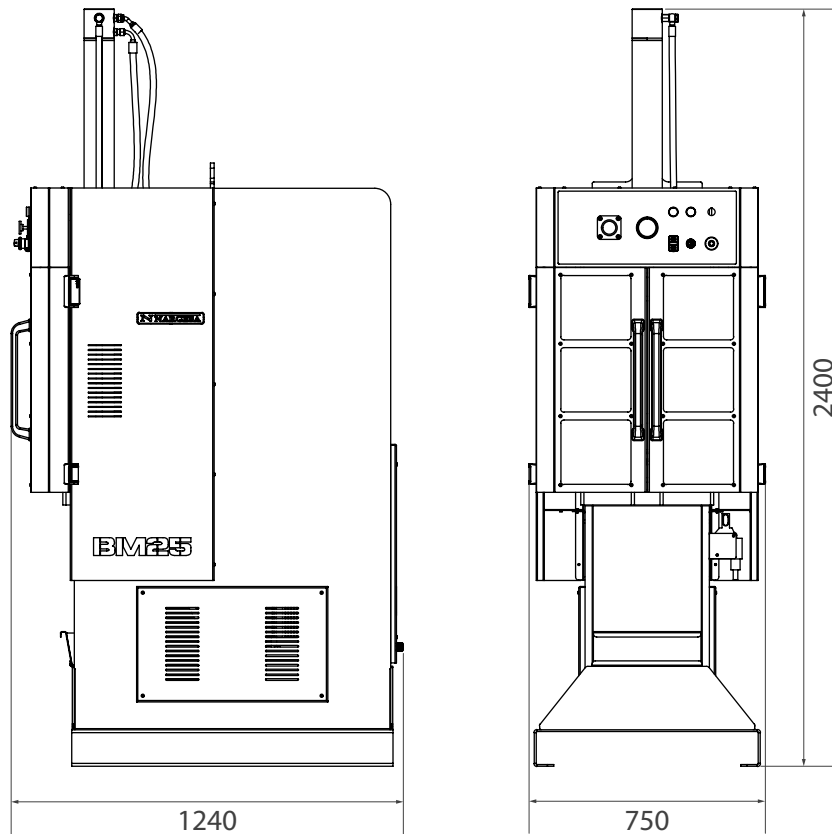

CHARACTERISTICS OF THE PACKAGING

- Tariff Item Code: 84624990
- Packing with steel pallet and retractile film.
- Optional: Complete wooden packing NIMF15

BM25

Width	790 mm
Length	1290 mm
Height	1900 mm
Volume	1,78 m ³
Nett Weight	850 Kg
Gross weight	855 Kg

OPTIONAL TOOLING

Broaches made of treated and rectified steel of first level to optimize the perfect finish of the piece and the exact tolerance.

Each set of broach is equipped with its required shims.

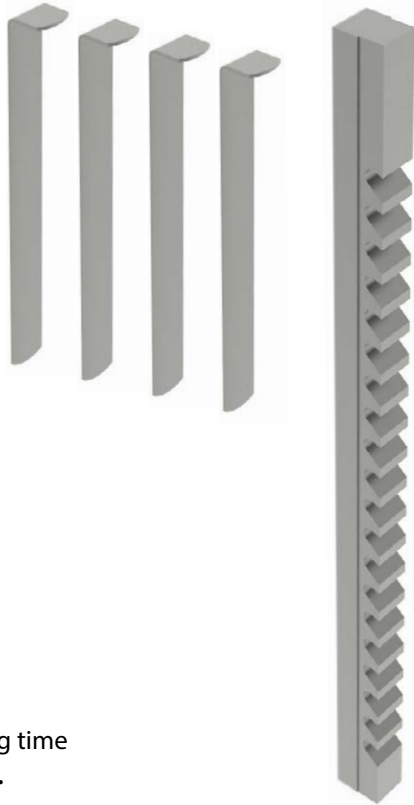

 Broaching time
5:00 min.

Keyway broaches 25mm

REF: 125-09-01-BR-00017

Tolerance: JS9 (-0,027 +0,013)

Model: F

Broach dimensions: 25,40 x 514,35mm

Standard keys: 25 x 14mm

Tooth pitch: 15,875mm

Number of Teeth: 26

Minimum cutting length: 25,4mm

Maximum cutting length: 152,4mm

Required pressure: 12.300lbs

Required pressure: 5.579,18Kg

Shims

Required shims: 4 units

Number of passes: 5

Thickness: 1,422mm

Bushings

Bushing diameter: 75, 80, 85, 90, 95, 100, 105, 110, 115 and 120mm

Bushing length: 152,4mm

Weight: 3,5 Kg. Approx.

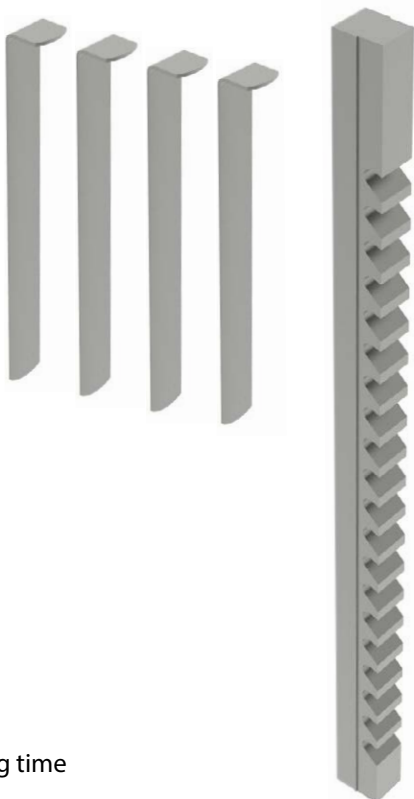

 Broaching time
5:00 min.

Keyway broaches 24mm

REF: 125-09-01-BR-00016

Tolerance: JS9 (-0,025 +0,015)

Model: F

Broach dimensions: 25,40 x 514,35mm

Standard keys: 24 x 14mm

Tooth pitch: 15,875mm

Number of Teeth: 26

Minimum cutting length: 25,4mm

Maximum cutting length: 152,4mm

Required pressure: 10.600lbs

Required pressure: 4.808,07Kg

Shims

Required shims: 4 units

Number of passes: 5

Thickness: 1,587mm

Bushings

Bushing diameter: 75, 80, 85, 90, 95, 100, 105, 110, 115 and 120mm

Bushing length: 152,4mm

Weight: 3,5 Kg. Approx.

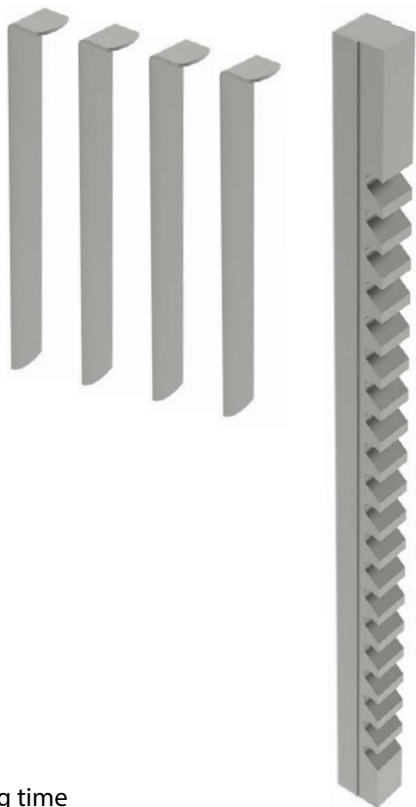

Keyway broaches 22mm

REF: 125-09-01-BR-00015

Tolerance: JS9 (-0,027 +0,014)

Model: F

Broach dimensions: 25,40 x 514,35mm

Standard keys: 22 x 14mm

Tooth pitch: 15,875mm

Number of Teeth: 26

Minimum cutting length: 25,4mm

Maximum cutting length: 152,4mm

Required pressure: 9.400lbs

Required pressure: 4.263,76Kg

Shims

Required shims: 4 units

Number of passes: 5

Thickness: 1,422mm

Bushings

Bushing diameter: 75, 80, 85, 90, 95, 100, 105, 110, 115 and 120mm

Bushing length: 152,4mm

Weight: 3,5 Kg. Approx.



Broaching time
5:00 min.

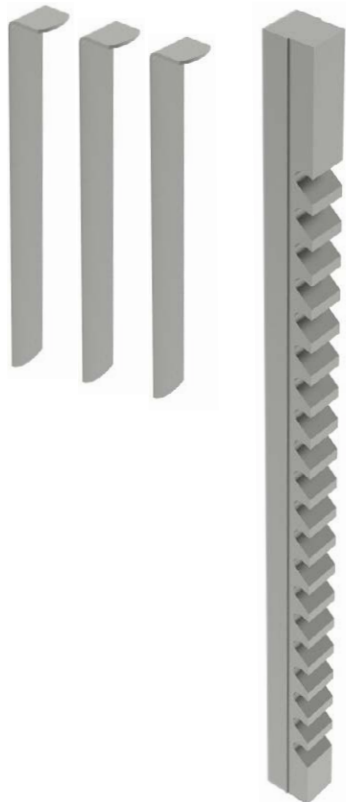

Keyway broaches 20mm

REF: 125-09-01-BR-00014

Tolerance: JS9 (-0,026 +0,015)

Model: F

Broach dimensions: 25,40 x 514,35mm

Standard keys: 20 x 12mm

Tooth pitch: 15,875mm

Number of Teeth: 26

Minimum cutting length: 25,4mm

Maximum cutting length: 152,4mm

Required pressure: 8.800lbs

Required pressure: 3.991,61Kg

Shims

Required shims: 3 units

Number of passes: 4

Thickness: 1,587mm

Bushings

Bushing diameter: 75, 80, 85, 90, 95, 100, 105, 110, 115 and 120mm

Bushing length: 152,4mm

Weight: 3,5 Kg. Approx.



Broaching time
4:20 min.

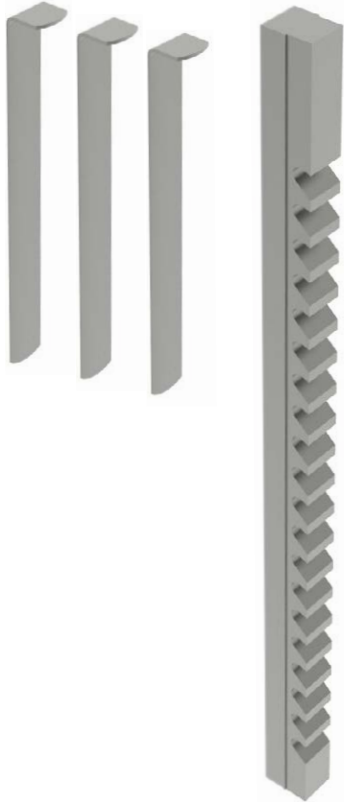

Keyway broaches 18mm

REF: 125-09-01-BR-00013

Tolerance: JS9 (-0,022 +0,013)

Model: E

Broach dimensions: 19,05 x 393,7mm

Standard keys: 18 x 11mm

Tooth pitch: 15,875mm

Number of Teeth: 20

Minimum cutting length: 25,4mm

Maximum cutting length: 152,4mm

Required pressure: 10.600lbs

Required pressure: 4.808,07Kg

Shims

Required shims: 3 units

Number of passes: 4

Thickness: 1,422mm

Bushings

Bushing diameter: 52, 54, 55, 56, 58, 60, 62, 63, 64, 65, 66, 68, 70 and 72mm

Bushing length: 127 and 152,4mm

Weight: 1,5 Kg. Approx.



Broaching time
3:40 min.

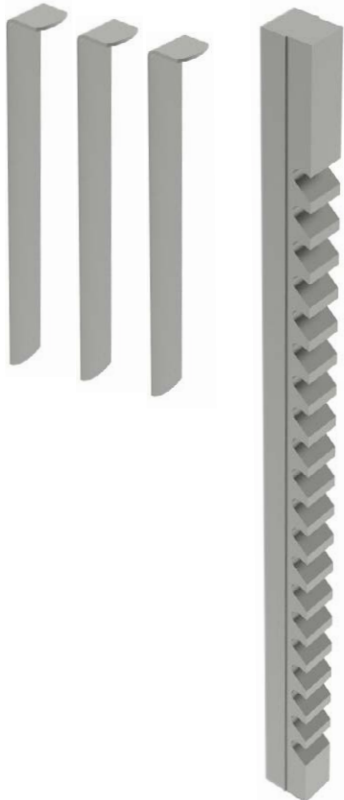

Keyway broaches 16mm

REF: 125-09-01-BR-00012

Tolerance: JS9 (-0,024 +0,012)

Model: E

Broach dimensions: 19,05 x 393,7mm

Standard keys: 16 x 10mm

Tooth pitch: 15,875mm

Number of Teeth: 20

Minimum cutting length: 25,4mm

Maximum cutting length: 152,4mm

Required pressure: 9.400lbs

Required pressure: 4.263,76Kg

Shims

Required shims: 3 units

Number of passes: 4

Thickness: 1,422mm

Bushings

Bushing diameter: 52, 54, 55, 56, 58, 60, 62, 63, 64, 65, 66, 68, 70 and 72mm

Bushing length: 127 and 152,4mm

Weight: 1,5 Kg. Approx.



Broaching time
3:40 min.

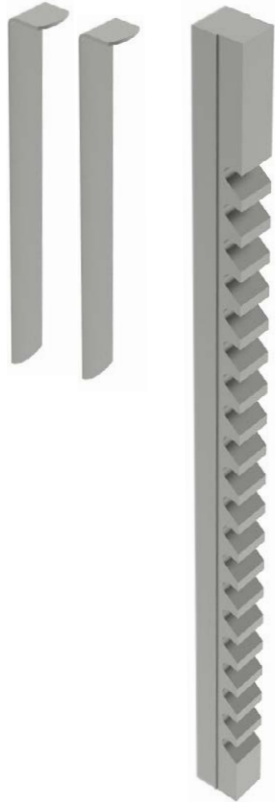

Keyway broaches 14mm

REF: 125-09-01-BR-00011

Tolerance: JS9 (-0,023 +0,013)

Model: D

Broach dimensions: 14,28 x 352,42mm

Standard keys: 14 x 9mm

Tooth pitch: 15,875mm

Number of Teeth: 17

Minimum cutting length: 25,4mm

Maximum cutting length: 152,4mm

Required pressure: 11.100lbs

Required pressure: 5.034,87Kg

Shims

Required shims: 2 units

Number of passes: 3

Thickness: 1,587mm

Bushings

Bushing diameter: 32, 34, 35, 36, 38, 40, 42, 44, 45, 46, 48, 50, 52, 54 and 56mm

Bushing length: 101,6 and 127mm

Weight: 1 Kg. Approx.



Broaching time
2:30 min.

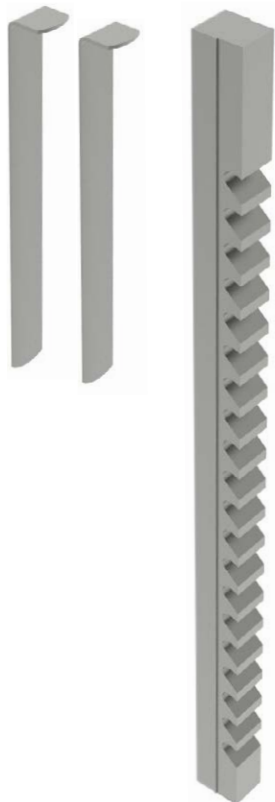

Keyway broaches 12mm

REF: 125-09-01-BR-00010

Tolerance: JS9 (-0,022 +0,014)

Model: D

Broach dimensions: 14,28 x 352,42mm

Standard keys: 12 x 8mm

Tooth pitch: 15,875mm

Number of Teeth: 17

Minimum cutting length: 25,4mm

Maximum cutting length: 152,4mm

Required pressure: 8.400lbs

Required pressure: 3.810,17Kg

Shims

Required shims: 2 units

Number of passes: 3

Thickness: 1,422mm

Bushings

Bushing diameter: 32, 34, 35, 36, 38, 40, 42, 44, 45, 46, 48, 50, 52, 54 and 56mm

Bushing length: 101,6 and 127mm

Weight: 1 Kg. Approx.



Broaching time
2:30 min.

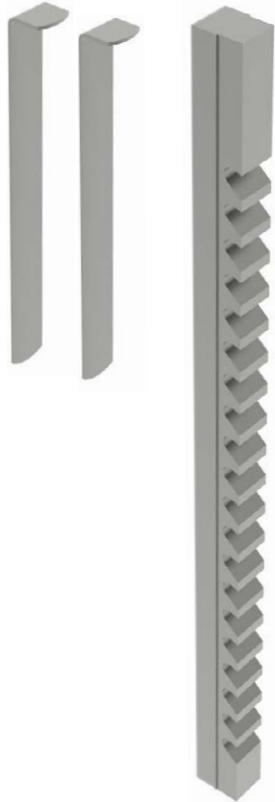

Keyway broaches 10mm

REF: 125-09-01-BR-00009

Tolerance: JS9 (-0,018 +0,012)

Model: D

Broach dimensions: 14,28 x 352,42mm

Standard keys: 10 x 8mm

Tooth pitch: 15,875mm

Number of Teeth: 17

Minimum cutting length: 25,4mm

Maximum cutting length: 152,4mm

Required pressure: 6.500lbs

Required pressure: 2.948,35Kg

Shims

Required shims: 2 units

Number of passes: 3

Thickness: 1,422mm

Bushings

Bushing diameter: 32, 34, 35, 36, 38, 40, 42, 44, 45, 46, 48, 50, 52, 54 and 56mm

Bushing length: 101,6 and 127mm

Weight: 1 Kg. Approx.



Broaching time
2:30 min.

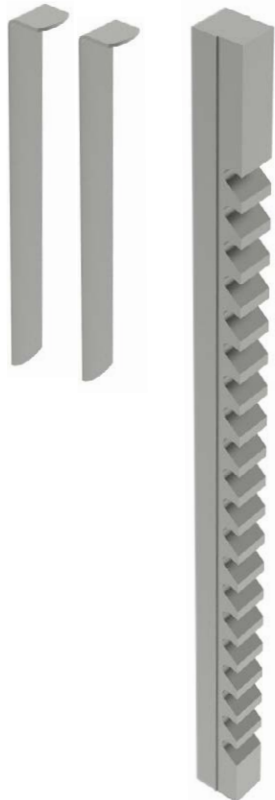

Keyway broaches 8mm

REF: 125-09-01-BR-00008

Tolerance: JS9 (-0,017 +0,013)

Model: C

Broach dimensions: 9,52 x 298,45mm

Standard keys: 8 x 7mm

Tooth pitch: 9,525mm

Number of Teeth: 22

Minimum cutting length: 9,921mm

Maximum cutting length: 63,5mm

Required pressure: 3.680lbs

Required pressure: 1.669,22Kg

Shims

Required shims: 2 units

Number of passes: 3

Thickness: 1,27mm

Bushings

Bushing diameter: 18, 19, 20, 22, 24, 25, 26, 28, 30, 32, 34, 35 and 36mm

Bushing length: 63,5mm

Weight: 0,350 Kg. Approx.



Broaching time
2:30 min.

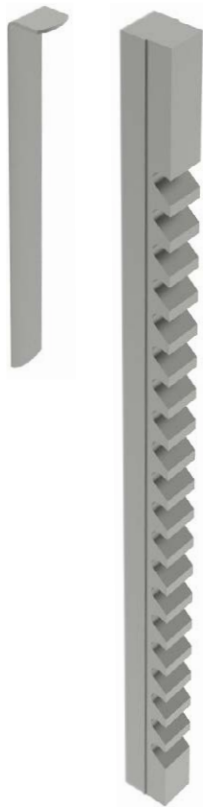

Keyway broaches 6mm

REF: 125-09-01-BR-00006

Tolerance: JS9 (-0,016 +0,009)

Model: C

Broach dimensions: 9,52 x 298,45mm

Standard keys: 6 x 6mm

Tooth pitch: 9,525mm

Number of Teeth: 22

Minimum cutting length: 9,921mm

Maximum cutting length: 63,5mm

Required pressure: 2.100lbs

Required pressure: 952,54Kg

Shims

Required shims: 1 unit

Number of passes: 2

Thickness: 1,587mm

Bushings

Bushing diameter: 18, 19, 20, 22, 24, 25, 26, 28, 30, 32, 34, 35 and 36mm

Bushing length: 63,5mm

Weight: 0,350 Kg. Approx.



Broaching time

1:20 min.

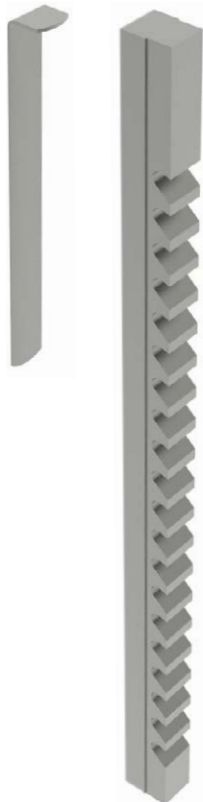

Keyway broaches 5mm

REF: 125-09-01-BR-00005

Tolerance: JS9 (-0,014 +0,008)

Model: C

Broach dimensions: 9,52 x 298,45mm

Standard keys: 5 x 5mm

Tooth pitch: 9,525mm

Number of Teeth: 22

Minimum cutting length: 9,921mm

Maximum cutting length: 63,5mm

Required pressure: 1.470lbs

Required pressure: 666,78Kg

Shims

Required shims: 1 unit

Number of passes: 2

Thickness: 1,193mm

Bushings

Bushing diameter: 18, 19, 20, 22, 24, 25, 26, 28, 30, 32, 34, 35 and 36mm

Bushing length: 63,5mm

Weight: 0,350 Kg. Approx.



Broaching time

1:20 min.

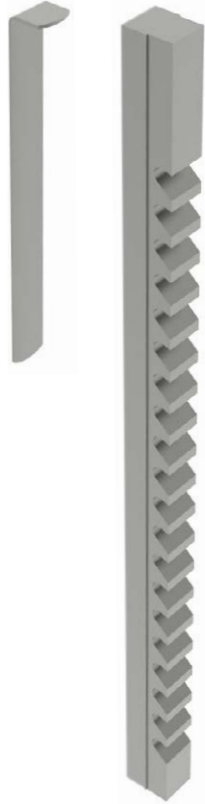

Keyway broaches 5mm

REF: 125-09-01-BR-00004

Tolerance: JS9 (-0,014 +0,008)

Model: B1

Broach dimensions: 6,35 x 171,45mm

Standard keys: 5 x 5mm

Tooth pitch: 7,143mm

Number of Teeth: 16

Minimum cutting length: 7,54mm

Maximum cutting length: 42,862mm

Required pressure: 1.860lbs

Required pressure: 843,68Kg

Shims

Required shims: 1 units

Number of passes: 2

Thickness: 1,27mm

Bushings

Bushing diameter: 12, 14, 15, 16, 17, 18 and 19mm

Bushing length: 42,862mm

Weight: 0,100 Kg. Approx.



Broaching time

1:00 min.

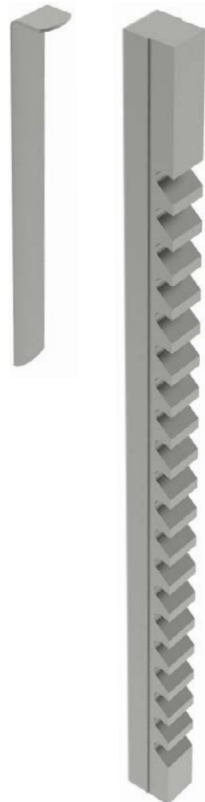

Keyway broaches 4mm

REF: 125-09-01-BR-00003

Tolerance: JS9 (-0,015 +0,01)

Model: B1

Broach dimensions: 6,35 x 171,45mm

Standard keys: 4 x 4mm

Tooth pitch: 7,143mm

Number of Teeth: 16

Minimum cutting length: 7,54mm

Maximum cutting length: 42,862mm

Required pressure: 1.140lbs

Required pressure: 517,09Kg

Shims

Required shims: 1 unit

Number of passes: 2

Thickness: 0,965mm

Bushings

Bushing diameter: 12, 14, 15, 16, 17, 18 and 19mm

Bushing length: 42,862mm

Weight: 0,100 Kg. Approx.



Broaching time

1:00 min.

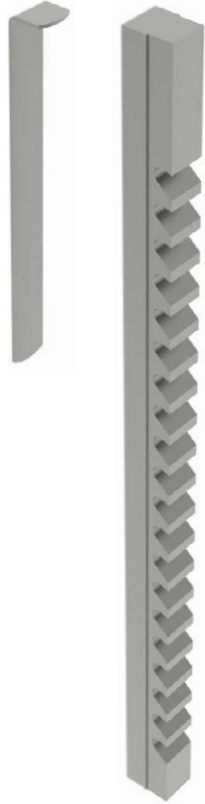

Keyway broaches 3mm

REF: 125-09-01-BR-00002

Tolerance: JS9 (-0,013 +0,009)

Model: A

Broach dimensions: 3,175 x 127mm

Standard keys: 3 x 3mm

Tooth pitch: 4,762mm

Number of Teeth: 18

Minimum cutting length: 5,159mm

Maximum cutting length: 28,575mm

Required pressure: 650lbs

Required pressure: 294,83Kg

Shims

Required shims: 1 unit

Number of passes: 2

Thickness: 0,787mm

Bushings

Bushing diameter: 6, 8, 10, 12 and 15mm

Bushing length: 28,575mm

Weight: 0,020 Kg. Approx.



Broaching time

0:45 min.



Keyway broaches 2mm

REF: 125-09-01-BR-00001

Tolerance: JS9 (-0,014 +0,009)

Model: A

Broach dimensions: 3,175 x 127mm

Standard keys: 2 x 2mm

Tooth pitch: 4,762mm

Number of Teeth: 18

Minimum cutting length: 5,159mm

Maximum cutting length: 28,575mm

Required pressure: 720lbs

Required pressure: 326,58Kg

Shims

Required shims: 0 units

Number of passes: 1

Bushings

Bushing diameter: 6, 8, 10, 12 and 15mm

Bushing length: 28,575mm

Weight: 0,020 Kg. Approx.



Broaching time

0:30 min.

Keyway broaches of different shapes

Keyway broaches to make slots of different polygonal shapes: squares, rectangles, hexagons...

Keyway broaches with special coating

Keyway broaches with TiN and TiAlN coating are supplied with the most common American standard (1/16" - 1") and metric sizes (2mm - 25mm).

The coatings provides greater performance through high lubricity and hardness, which allows greater production in their most demanding materials. The keyway broaches are supplied with the necessary shims.

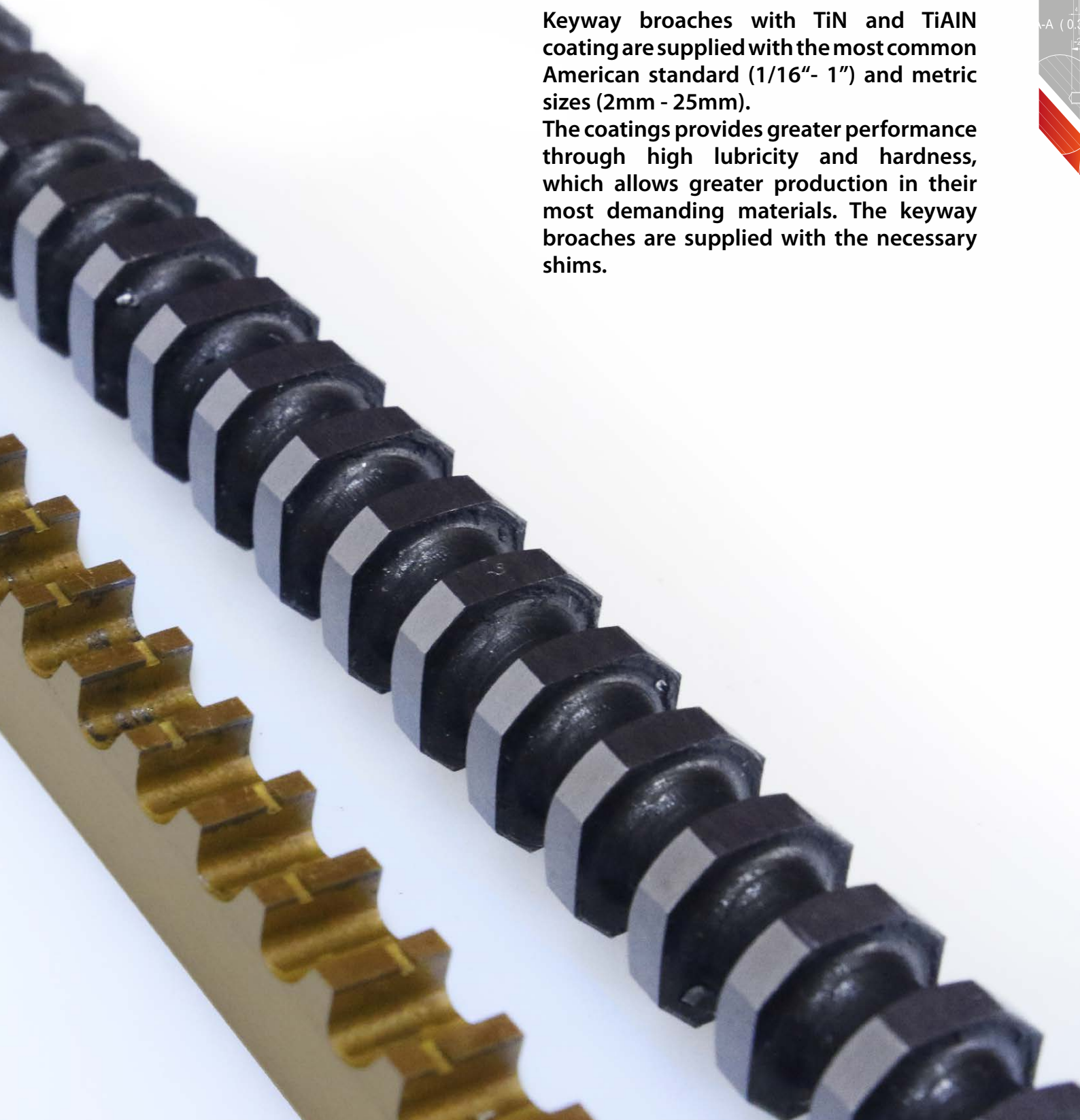

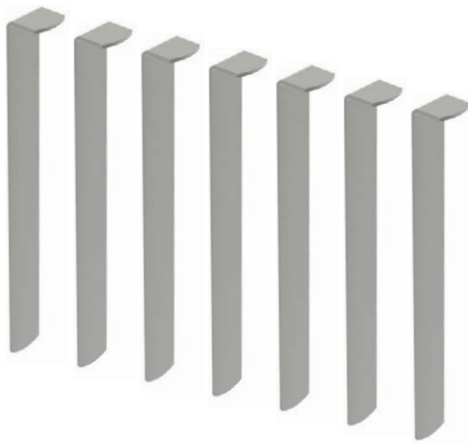

Keyway broaches 1 inch

REF: 125-09-01-BRP-00020

Tolerance: JS9 (1,0015 - 1,0025)

Model: F

Broach dimensions: 1 x 20 1/4 inches

Tooth pitch: 5/8 inch

Number of Teeth: 26

Minimum cutting length: 1 inch

Maximum cutting length: 6 inches

Required pressure: 11.100lbs

Shims

Required shims: 7 units

Number of passes: 8

Thickness: 0,0625 inches

Bushings

Bushing diameter: 3 1/16, 3 1/8, 3 3/16, 3 1/4, 3 5/16, 3 3/8, 3 7/16, 3 1/2, 3 9/16, 3 5/8, 3 11/16, 3 3/4, 3 13/16, 3 7/8, 3 15/16, 4, 4 1/16, 4 1/8, 4 3/16, 4 1/4, 4 5/16, 4 3/8, 4 7/16, 4 1/2, 7 9/16, 4 5/8, 4 11/16, 4 3/4, 4 13/16, 4 7/8, 4 15/16 and 5 inches

Bushing length: 6 inches

Weight: 3,5 Kg. Approx.



Broaching time

8:00 min.

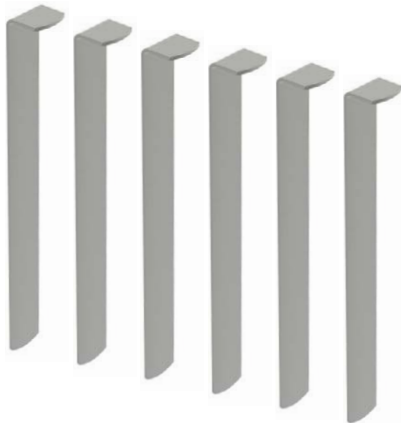

Keyway broaches 7/8 inch

REF: 125-09-01-BRP-00019

Tolerance: JS9 (0,8765 - 0,8775)

Model: F

Broach dimensions: 1 x 20 1/4 inches

Tooth pitch: 5/8 inch

Number of Teeth: 26

Minimum cutting length: 1 inch

Maximum cutting length: 6 inches

Required pressure: 9.800lbs

Shims

Required shims: 6 units

Number of passes: 7

Thickness: 0,0625 inches

Bushings

Bushing diameter: 3 1/16, 3 1/8, 3 3/16, 3 1/4, 3 5/16, 3 3/8, 3 7/16, 3 1/2, 3 9/16, 3 5/8, 3 11/16, 3 3/4, 3 13/16, 3 7/8, 3 15/16, 4, 4 1/16, 4 1/8, 4 3/16, 4 1/4, 4 5/16, 4 3/8, 4 7/16, 4 1/2, 7 9/16, 4 5/8, 4 11/16, 4 3/4, 4 13/16, 4 7/8, 4 15/16 and 5 inches

Bushing length: 6 inches

Weight: 3,5 Kg. Approx.



Broaching time

6:00 min.

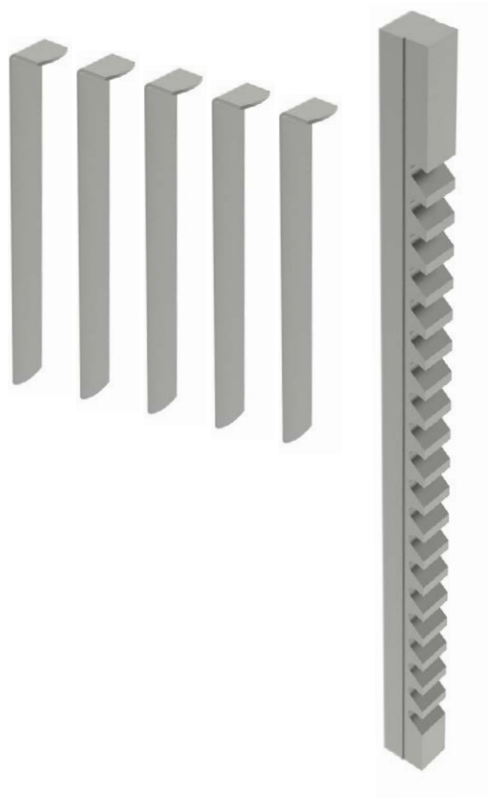

Keyway broaches 3/4 inch

REF: 125-09-01-BRP-00018

Tolerance: JS9 (0,7515 · 0,7525)

Model: E

Broach dimensions: 3/4 x 15 1/2 inches

Tooth pitch: 5/8 inch

Number of Teeth: 20

Minimum cutting length: 1 inch

Maximum cutting length: 6 inches

Required pressure: 11.900lbs

Shims

Required shims: 5 units

Number of passes: 6

Thickness: 0,0625 inches

Bushings

Bushing diameter: 2 5/16, 2 3/8, 2 7/16, 2 1/2, 2 9/16, 2 5/8, 2 11/16, 2 3/4, 2 13/16, 2 7/8, 2 15/16, 3, 3 1/16, 3 1/8, 3 3/16, 3 1/4, 3 5/16, 3 3/8, 3 7/16, 3 1/2, 3 9/16, 3 5/8, 3 11/16, 3 3/4, 3 13/16, 3 7/8, 3 15/16 and 4 inches

Bushing length: 6 inches

Weight: 1,5 Kg. Approx.



Broaching time

5:00 min.

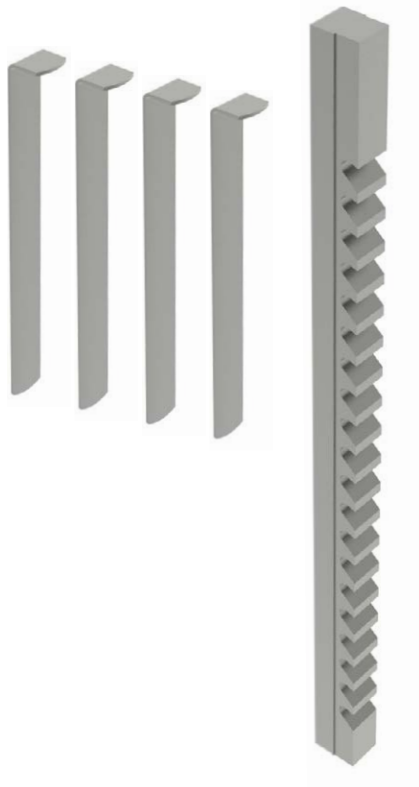

Keyway broaches 5/8 inch

REF: 125-09-01-BRP-00017

Tolerance: JS9 (0,6260 · 0,6270)

Model: E

Broach dimensions: 5/8 x 15 1/2 inches

Tooth pitch: 5/8 inch

Number of Teeth: 20

Minimum cutting length: 1 inch

Maximum cutting length: 6 inches

Required pressure: 9.600lbs

Shims

Required shims: 4 units

Number of passes: 5

Thickness: 0,0625 inches

Bushings

Bushing diameter: 2 5/16, 2 3/8, 2 7/16, 2 1/2, 2 9/16, 2 5/8, 2 11/16, 2 3/4, 2 13/16, 2 7/8, 2 15/16, 3, 3 1/16, 3 1/8, 3 3/16, 3 1/4, 3 5/16, 3 3/8, 3 7/16, 3 1/2, 3 9/16, 3 5/8, 3 11/16, 3 3/4, 3 13/16, 3 7/8, 3 15/16 and 4 inches

Bushing length: 6 inches

Weight: 1,5 Kg. Approx.



Broaching time

4:00 min.

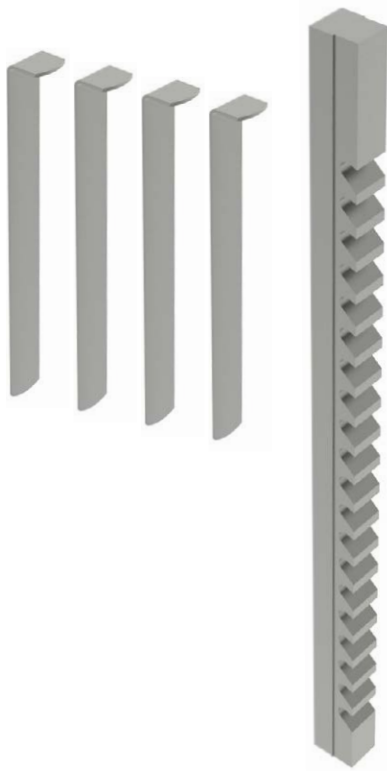

Keyway broaches 9/16 inch

REF: 125-09-01-BRP-00016

Tolerance: JS9 (0,5631 - 0,5641)

Model: D

Broach dimensions: 9/16 x 13 7/8 inches

Tooth pitch: 5/8 inch

Number of Teeth: 17

Minimum cutting length: 1 inch

Maximum cutting length: 6 inches

Required pressure: 8.900lbs

Shims

Required shims: 4 units

Number of passes: 5

Thickness: 0,0560 inches

Bushings

Bushing diameter: 1 7/16, 1 1/2, 1 9/16, 1 5/8,
1 11/16, 1 3/4, 1 13/16, 1 7/8, 1 15/16, 2, 2 1/16, 2 1/8,
2 3/16, 2 1/4, 2 5/16, 2 3/8, 2 7/16, 2 1/2, 2 9/16, 2 5/8,
2 11/16, 2 3/4, 2 13/16, 2 7/8, 2 15/16 and 3 inches
Bushing length: 4, 5 and 6 inches

Weight: 1,00 Kg. Approx.



Broaching time

3:40 min.

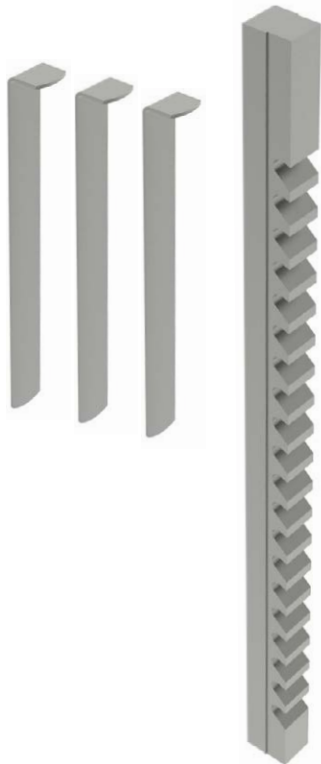

Keyway broaches 1/2 inch

REF: 125-09-01-BRP-00015

Tolerance: JS9 (0,5006 - 0,5016)

Model: D

Broach dimensions: 9/16 x 13 7/8 inches

Tooth pitch: 5/8 inches

Number of Teeth: 17

Minimum cutting length: 1 inch

Maximum cutting length: 6 inches

Required pressure: 9.800lbs

Shims

Required shims: 3 units

Number of passes: 4

Thickness: 0,0625 inches

Bushings

Bushing diameter: 1 7/16, 1 1/2, 1 9/16, 1 5/8,
1 11/16, 1 3/4, 1 13/16, 1 7/8, 1 15/16, 2, 2 1/16, 2 1/8,
2 3/16, 2 1/4, 2 5/16, 2 3/8, 2 7/16, 2 1/2, 2 9/16, 2 5/8,
2 11/16, 2 3/4, 2 13/16, 2 7/8, 2 15/16 and 3 inches
Bushing length: 4, 5 and 6 inches

Weight: 1,00 Kg. Approx.



Broaching time

3:00 min.

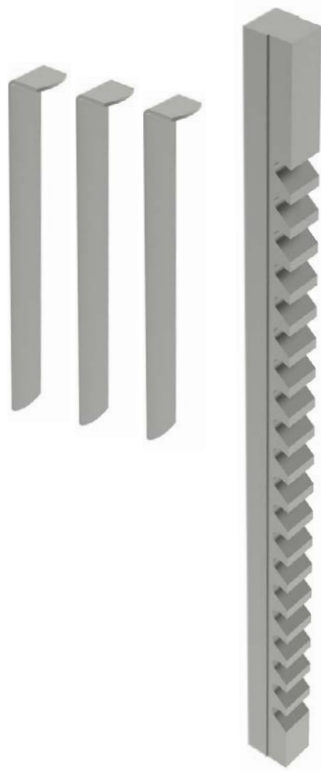

Keyway broaches 7/16 inch

REF: 125-09-01-BRP-00014

Tolerance: JS9 (0,4380 - 0,4390)

Model: D

Broach dimensions: 9/16 x 13 7/8 inches

Tooth pitch: 5/8 inch

Number of Teeth: 17

Minimum cutting length: 1 inch

Maximum cutting length: 6 inches

Required pressure: 9.400lbs

Shims

Required shims: 3 units

Number of passes: 4

Thickness: 0,0560 inches

Bushings

Bushing diameter: 1 7/16, 1 1/2, 1 9/16, 1 5/8,
1 11/16, 1 3/4, 1 13/16, 1 7/8, 1 15/16, 2, 2 1/16, 2 1/8,
2 3/16, 2 1/4, 2 5/16, 2 3/8, 2 7/16, 2 1/2, 2 9/16, 2 5/8,
2 11/16, 2 3/4, 2 13/16, 2 7/8, 2 15/16 and 3 inches
Bushing length: 4, 5 and 6 inches

Weight: 1,00 Kg. Approx.



Broaching time

3:00 min.

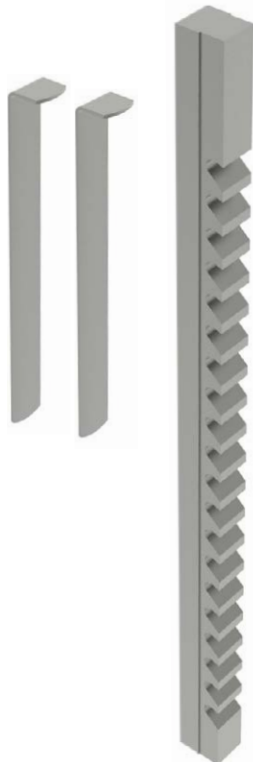

Keyway broaches 3/8 inch

REF: 125-09-01-BRP-00013

Tolerance: JS9 (0,3755 - 0,3765)

Model: D

Broach dimensions: 9/16 x 13 7/8 inches

Tooth pitch: 5/8 inch

Number of Teeth: 17

Minimum cutting length: 1 inch

Maximum cutting length: 6 inches

Required pressure: 7.000lbs

Shims

Required shims: 2 units

Number of passes: 3

Thickness: 0,0625 inches

Bushings

Bushing diameter: 1 7/16, 1 1/2, 1 9/16, 1 5/8,
1 11/16, 1 3/4, 1 13/16, 1 7/8, 1 15/16, 2, 2 1/16, 2 1/8,
2 3/16, 2 1/4, 2 5/16, 2 3/8, 2 7/16, 2 1/2, 2 9/16, 2 5/8,
2 11/16, 2 3/4, 2 13/16, 2 7/8, 2 15/16 and 3 inches
Bushing length: 4, 5 and 6 inches

Weight: 1,00 Kg. Approx.



Broaching time

2:30 min.

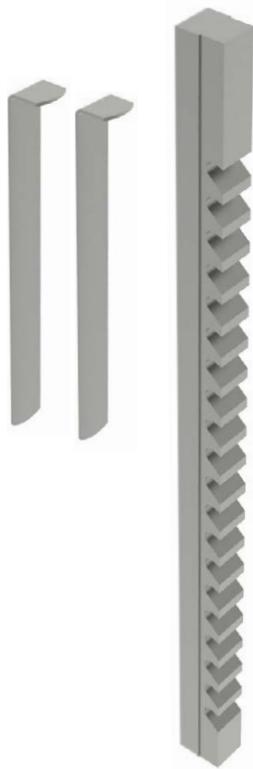

Keyway broaches 5/16 inch

REF: 125-09-01-BRP-00012

Tolerance: JS9 (0,3127 - 0,3137)

Model: D

Broach dimensions: 9/16 x 13 7/8 inches

Tooth pitch: 5/8 inch

Number of Teeth: 17

Minimum cutting length: 1 inch

Maximum cutting length: 6 inches

Required pressure: 8.000lbs

Shims

Required shims: 2 units

Number of passes: 3

Thickness: 0,0560 inches

Bushings

Bushing diameter: 1 7/16, 1 1/2, 1 9/16, 1 5/8,
1 11/16, 1 3/4, 1 13/16, 1 7/8, 1 15/16, 2, 2 1/16, 2 1/8,
2 3/16, 2 1/4, 2 5/16, 2 3/8, 2 7/16, 2 1/2, 2 9/16, 2 5/8,
2 11/16, 2 3/4, 2 13/16, 2 7/8, 2 15/16 and 3 inches
Bushing length: 4, 5 and 6 inches

Weight: 1,00 Kg. Approx.



Broaching time

2:30 min.

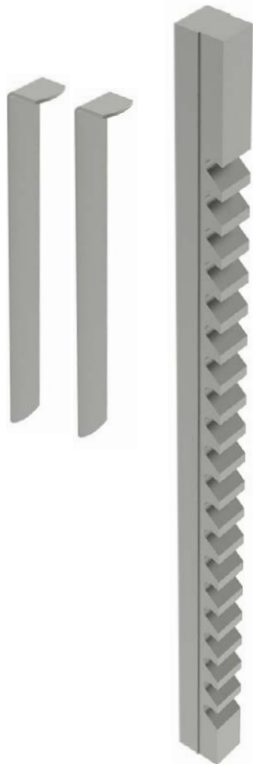

Keyway broaches 3/8 inch

REF: 125-09-01-BRP-00011

Tolerance: JS9 (0,3755 - 0,3765)

Model: C

Broach dimensions: 3/8 x 11 3/4 inches

Tooth pitch: 3/8 inch

Number of Teeth: 22

Minimum cutting length: 25/64 inch

Maximum cutting length: 2 1/2 inches

Required pressure: 4.340lbs

Shims

Required shims: 2 units

Number of passes: 3

Thickness: 0,0625 inches

Bushings

Bushing diameter: 3/4, 13/16, 7/8, 15/16, 1, 1 1/16,
1 1/8, 1 3/16, 1 1/4, 1 5/16, 1 3/8, 1 7/16, 1 1/2 and
1 9/16 inches

Bushing length: 2 1/2 inches

Weight: 0,350 Kg. Approx.



Broaching time

2:30 min.

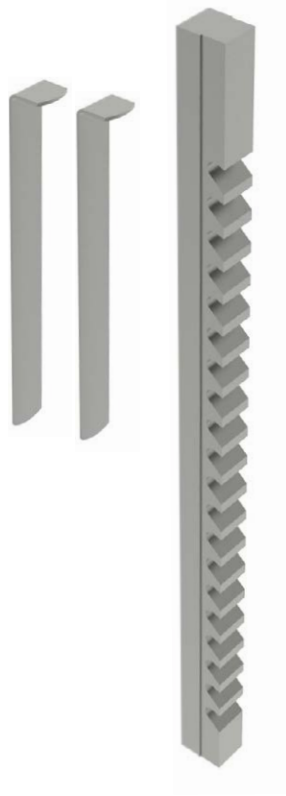

Keyway broaches 5/16 inch

REF: 125-09-01-BRP-00010

Tolerance: JS9 (0,3127 - 0,3137)

Model: C

Broach dimensions: 3/8 x 11 3/4 inches

Tooth pitch: 3/8 inch

Number of Teeth: 22

Minimum cutting length: 25/64 inch

Maximum cutting length: 2 1/2 inches

Required pressure: 3.960lbs

Shims

Required shims: 2 units

Number of passes: 3

Thickness: 0,0550 inches

Bushings

Bushing diameter: 3/4, 13/16, 7/8, 15/16, 1, 1 1/16,

1 1/8, 1 3/16, 1 1/4, 1 5/16, 1 3/8, 1 7/16, 1 1/2 and

1 9/16 inches

Bushing length: 2 1/2 inches

Weight: 0,350 Kg. Approx.



Broaching time

2:30 min.

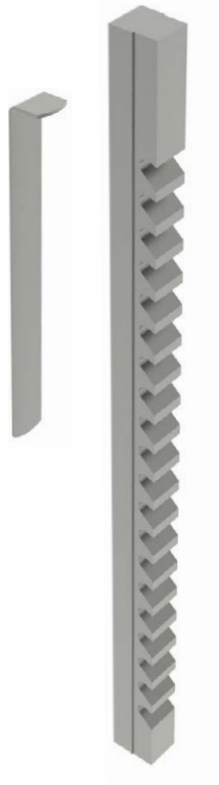

Keyway broaches 1/4 inch

REF: 125-09-01-BRP-00009

Tolerance: JS9 (0,2502 - 0,2512)

Model: C

Broach dimensions: 3/8 x 11 3/4 inches

Tooth pitch: 3/8 inch

Number of Teeth: 22

Minimum cutting length: 25/64 inch

Maximum cutting length: 2 1/2 inches

Required pressure: 2.520lbs

Shims

Required shims: 1 unit

Number of passes: 2

Thickness: 0,0625 inches

Bushings

Bushing diameter: 3/4, 13/16, 7/8, 15/16, 1, 1 1/16,

1 1/8, 1 3/16, 1 1/4, 1 5/16, 1 3/8, 1 7/16, 1 1/2 and

1 9/16 inches

Bushing length: 2 1/2 inches

Weight: 0,350 Kg. Approx.



Broaching time

1:20 min.

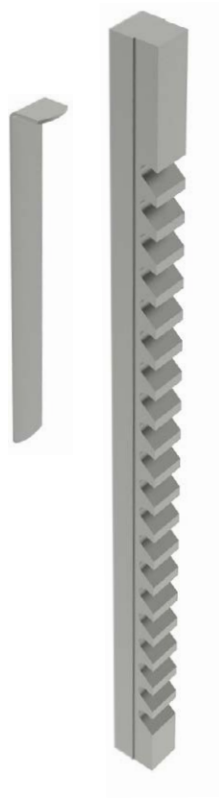

Keyway broaches 3/16 inch

REF: 125-09-01-BRP-00008

Tolerance: JS9 (0,1877 · 0,1887)

Model: C

Broach dimensions: 3/8 x 11 3/4 inches

Tooth pitch: 3/8 inch

Number of Teeth: 22

Minimum cutting length: 25/64 inch

Maximum cutting length: 2 1/2 inches

Required pressure: 1.540lbs

Shims

Required shims: 1 unit

Number of passes: 2

Thickness: 0,0500 inches

Bushings

Bushing diameter: 3/4, 13/16, 7/8, 15/16, 1, 1 1/16,

1 1/8, 1 3/16, 1 1/4, 1 5/16, 1 3/8, 1 7/16, 1 1/2 and

1 9/16 inches

Bushing length: 2 1/2 inches

Weight: 0,350 Kg. Approx.



Broaching time

1:20 min.

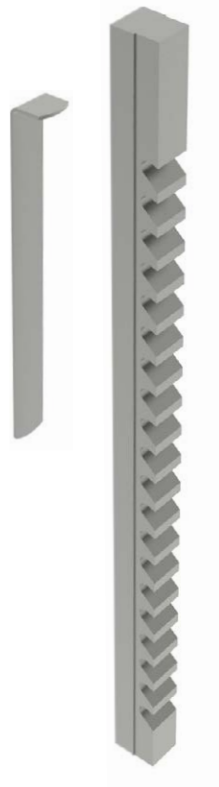

Keyway broaches 3/16 inch

REF: 125-09-01-BRP-00007

Tolerance: JS9 (0,1877 · 0,1887)

Model: B

Broach dimensions: 3/16 x 6 3/4 inches

Tooth pitch: 9/32 inch

Number of Teeth: 16

Minimum cutting length: 19/64 inch

Maximum cutting length: 1 11/16 inches

Required pressure: 1.860lbs

Shims

Required shims: 1 unit

Number of passes: 2

Thickness: 0,0500 inches

Bushings

Bushing diameter: 1/2, 9/16, 5/8, 11/16, 3/4, 13/16 and

7/8 inch

Bushing length: 1 11/16 inches

Weight: 0,100 Kg. Approx.



Broaching time

1:00 min.

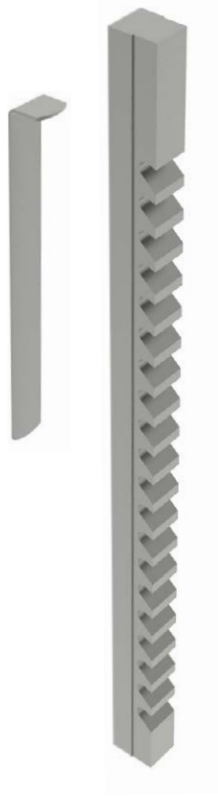

Keyway broaches 5/32 inch

REF: 125-09-01-BRP-00006

Tolerance: JS9 (0,1564 · 0,1574)

Model: B

Broach dimensions: 3/16 x 6 3/4 inches

Tooth pitch: 9/32 inch

Number of Teeth: 16

Minimum cutting length: 19/64 inch

Maximum cutting length: 1 11/16 inches

Required pressure: 1.320lbs

Shims

Required shims: 1 unit

Number of passes: 2

Thickness: 0,0420 inches

Bushings

Bushing diameter: 1/2, 9/16, 5/8, 11/16, 3/4, 13/16 and 7/8 inch

Bushing length: 1 11/16 inch

Weight: 0,100 Kg. Approx.



Broaching time

1:00 min.

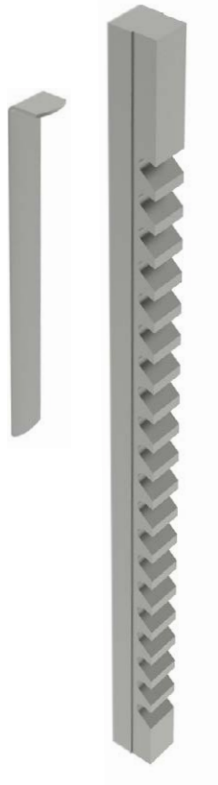

Keyway broaches 1/8 inch

REF: 125-09-01-BRP-00005

Tolerance: JS9 (0,1252 · 0,1262)

Model: B

Broach dimensions: 3/16 x 6 3/4 inches

Tooth pitch: 9/32 inch

Number of Teeth: 16

Minimum cutting length: 19/64 inch

Maximum cutting length: 1 11/16 inch

Required pressure: 720lbs

Shims

Required shims: 1 unit

Number of passes: 2

Thickness: 0,0310 inches

Bushings

Bushing diameter: 1/2, 9/16, 5/8, 11/16, 3/4, 13/16 and 7/8 inch

Bushing length: 1 11/16 inch

Weight: 0,100 Kg. Approx.



Broaching time

1:00 min.



Keyway broaches 3/32 inch

REF: 125-09-01-BRP-00004

Tolerance: JS9 (0,0938 · 0,0948)

Model: B

Broach dimensions: 3/16 x 6 3/4 inches

Tooth pitch: 9/32 inch

Number of Teeth: 16

Minimum cutting length: 19/64 inch

Maximum cutting length: 1 11/16 inch

Required pressure: 930lbs

Shims

Required shims: 0 units

Number of passes: 1

Bushings

Bushing diameter: 1/2, 9/16, 5/8, 11/16, 3/4, 13/16 and 7/8 inch

Bushing length: 1 11/16 inch

Weight: 0,100 Kg. Approx.



Broaching time

0:40 min.

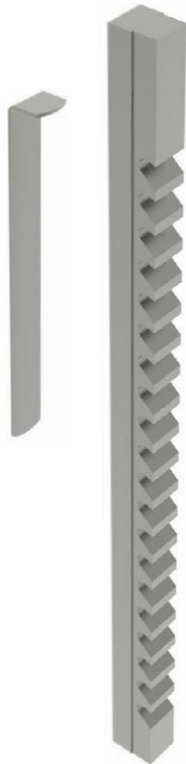

Keyway broaches 1/8 inch

REF: 125-09-01-BRP-00003

Tolerance: JS9 (0,1252 · 0,1262)

Model: A

Broach dimensions: 1/8 x 5 inches

Tooth pitch: 3/16 inches

Number of Teeth: 18

Minimum cutting length: 13/64 inch

Maximum cutting length: 1 1/8 inch

Required pressure: 650lbs

Shims

Required shims: 1 unit

Number of passes: 2

Thickness: 0,0310 inches

Bushings

Bushing diameter: 1/4, 5/16, 3/8, 7/16 and 1/2 inch

Bushing length: 1 1/8 inch

Weight: 0,020 Kg. Approx.



Broaching time

0:45 min.



Keyway broaches 3/32 inch

REF: 125-09-01-BRP-00002

Tolerance: JS9 (0,0938 - 0,0948)

Model: A

Broach dimensions: 1/8 x 5 inches

Tooth pitch: 3/16 inches

Number of Teeth: 18

Minimum cutting length: 13/64 inch

Maximum cutting length: 1 1/8 inches

Required pressure: 780lbs

Shims

Required shims: 0 units

Number of passes: 1

Bushings

Bushing diameter: 1/4, 5/16, 3/8, 7/16 and 1/2 inch

Bushing length: 1 1/8 inches

Weight: 0,020 Kg. Approx.



Broaching time

0:30 min.



Keyway broaches 1/16 inch

REF: 125-09-01-BRP-00001

Tolerance: JS9 (0,0625 - 0,0635)

Model: A

Broach dimensions: 1/8 x 5 inches

Tooth pitch: 3/16 inches

Number of Teeth: 18

Minimum cutting length: 13/64 inch

Maximum cutting length: 1 1/8 inches

Required pressure: 390lbs

Shims

Required shims: 0 units

Number of passes: 1

Bushings

Bushing diameter: 1/4, 5/16, 3/8, 7/16 and 1/2 inch

Bushing length: 1 1/8 inches

Weight: 0,020 Kg. Approx.



Broaching time

0:30 min.



Bushings

F114 steel guide bushes in H8 diameter tolerance to optimize the perfect finish of the part.

For other dimensions, request the manufacturer.

Reference	Model	Diameter	Length	Tolerance	Broaches
125-09-01-CBR-00002	A	10 mm	32 mm	J9	2 - 3 mm
125-09-01-CBR-00004	B	12 mm	46 mm	J9	4 - 5C mm
125-09-01-CBR-00005	B	14 mm	46 mm	J9	4 - 5C mm
125-09-01-CBR-00006	B	16 mm	46 mm	J9	4 - 5C mm
125-09-01-CBR-00007	B	17 mm	46 mm	J9	4 - 5C mm
125-09-01-CBR-00008	C	18 mm	65 mm	J9	5 - 6 - 8 mm
125-09-01-CBR-00009	C	19 mm	65 mm	J9	5 - 6 - 8 mm
125-09-01-CBR-00010	C	20 mm	65 mm	J9	5 - 6 - 8 mm
125-09-01-CBR-00011	C	22 mm	65 mm	J9	5 - 6 - 8 mm
125-09-01-CBR-00012	C	24 mm	65 mm	J9	5 - 6 - 8 mm
125-09-01-CBR-00013	C	25 mm	65 mm	J9	5 - 6 - 8 mm
125-09-01-CBR-00014	C	28 mm	65 mm	J9	5 - 6 - 8 mm
125-09-01-CBR-00015	C	30 mm	65 mm	J9	5 - 6 - 8 mm
125-09-01-CBR-00016	D	32 mm	102 mm	J9	10 - 12 - 14 mm
125-09-01-CBR-00017	D	35 mm	102 mm	J9	10 - 12 - 14 mm
125-09-01-CBR-00018	D	38 mm	102 mm	J9	10 - 12 - 14 mm
125-09-01-CBR-00020	D	40 mm	102 mm	J9	10 - 12 - 14 mm
125-09-01-CBR-00021	D	42 mm	102 mm	J9	10 - 12 - 14 mm
125-09-01-CBR-00022	D	45 mm	127 mm	J9	10 - 12 - 14 mm
125-09-01-CBR-00023	D	48 mm	127 mm	J9	10 - 12 - 14 mm
125-09-01-CBR-00024	D	50 mm	127 mm	J9	10 - 12 - 14 mm
125-09-01-CBR-00025	E	55 mm	127 mm	J9	16 - 18 mm
125-09-01-CBR-00026	E	60 mm	154 mm	J9	16 - 18 mm
125-09-01-CBR-00027	E	65 mm	154 mm	J9	16 - 18 mm
125-09-01-CBR-00028	F	70 mm	154 mm	J9	20 - 22 - 24 - 25 mm
125-09-01-CBR-00029	F	75 mm	154 mm	J9	20 - 22 - 24 - 25 mm
125-09-01-CBR-00030	F	80 mm	154 mm	J9	20 - 22 - 24 - 25 mm
125-09-01-CBR-00031	F	85 mm	154 mm	J9	20 - 22 - 24 - 25 mm
125-09-01-CBR-00032	F	90 mm	154 mm	J9	20 - 22 - 24 - 25 mm
125-09-01-CBR-00033	F	95 mm	154 mm	J9	20 - 22 - 24 - 25 mm

OUR RANGE OF MACHINERY



IRON WORKERS



SECTION BENDING
MACHINES



NON-MANDREL PIPE BENDER



HORIZONTAL PRESS BRAKES



TWISTING/SCROLL BENDING
MACHINES



HYDRAULIC PRESS BRAKES



HYDRAULIC SHEAR
MACHINES



GAS FORGES



IRON EMBOSSING MACHINES



END WROUGHT IRON
MACHINES



BROACHING MACHINES



POWER HAMMERS



PRESSES FOR LOCKS

WARRANTY

Nargesa machines have 3 years warranty provided that the customer registers it in our website. Otherwise it would be only one year warranty. This one encloses any manufacturing default all along these 3 years for components. Any misuse is excluded from this condition. Labor, back and forth shipping and any eventual repair, are not included in this warranty.

Partner companies



Airpharm

SHIPMENT EVERYWHERE

Nargesa will arrange transport up to final destination, whenever the customers asks for so. There is also the possibility for the customer to arrange the shipment himself with his own agency.

TECHNICAL ASSISTANCE

All our customers have access to technical support quickly and efficiently.

90% of incidences are solved out on the phone, mail, Skype or videoconferencing in less than 24hours. In case of needing presencial technical assistance, we may as well send a technician to the customer's facilities.

Follow us on

PRADA NARGESA, S.L.

Ctra. De Garrigàs a Sant Miquel s/n
17476 Palau de Santa Eulalia (Girona) Spain
Tel. +34 972 568 085

www.nargesa.com

nargesa@nargesa.com



This information might undergo changes