

SECTION BENDING MACHINE

MC550

NS: 2023-112/161

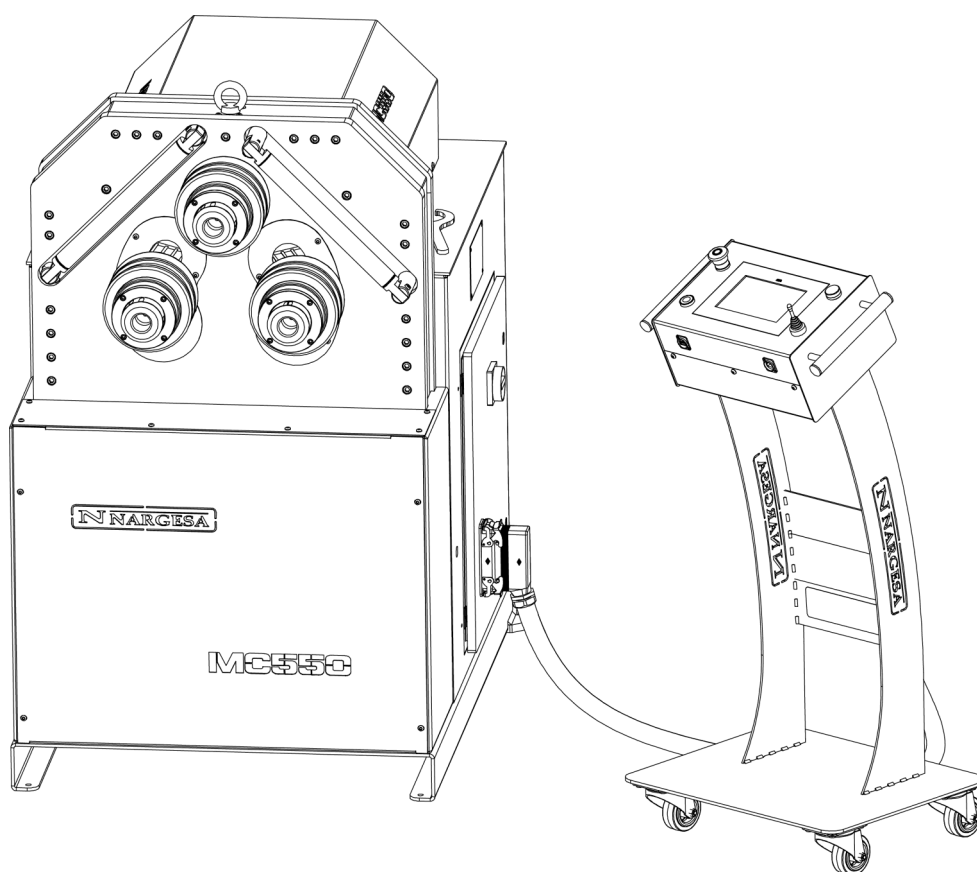

INSTRUCTIONS BOOK

PRADA NARGESA, S.L

Ctra. de Garrigàs a Sant Miquel s/n · 17476 Palau de Santa Eulàlia (Girona) SPAIN

Tel. +34 972568085 · nargesa@nargesa.com · www.nargesa.com

NARGESA CLIENTS

Prada Nargesa has more than 8.000 customers around the world. Some of our clients, those who offer service to third parties with the Nargesa machinery in their workshops, have been pleased to be part of this network that aims to connect them with possible future clients. In this way, all those people or companies that have a need for any part or tool that can be manufactured by using the Nargesa range of machinery, will be able to find a solution in their area to be able to satisfy their production requirements by hiring their services.



We have more than 8.500 customers in 150 different countries around the world

Discover its location on the interactive map on our website!

DO YOU WANT TO PARTICIPATE?

Send an email to nargesa@nargesa.com, include the following information and we will add you to this list.

We want to encourage all those who haven't participated yet in this great commercial network!

1. Company name
2. CIF/Tax Code
3. City
4. Country
5. Machine or machines

PRADA NARGESA

Prada Nargesa S.L. is a family business founded in 1970 located near Barcelona, Spain, with more than 50 years of experience in the sector of manufacturing of industrial machinery, and more than 10.000m² of facilities. Nargesa is a symbol of quality, reliability, warranty and innovation.

Our whole range of machines and accessories is manufactured entirely in Nargesa. We have a constant stock of 400 machines, and we have more than 16.800 machines sold all over the world.



OUR RANGE OF MACHINERY

Ironworker Machines

Ring Roller Bender and Pipe Bender

Non-mandrel Tube and Pipe Bender

Twisting / Scroll Bending Machines

Horizontal Press Brakes

End Wrought Iron Machines

Gas Forges

Iron Embossing Machines

Hydraulic Shear Machines

Hydraulic Press Brakes

Presses for Locks

Broaching Machines

Power Hammers

CERTIFICATES

Prada Nargesa has several certifications that backup both, the design and manufacturing processes, as well as the journey through exporting our products around the world and the quality of the manufacturing components we use for our machines. These facts turn into real advantages for our customers:



AUTHORIZED EXPORTER

- Faster customs procedures
- Reduction of tariff documentation
- Tariff preferences according to geographical location



INNOVATIVE SME

- Development in innovation, design and manufacturing technologies
- Certification and audit of efficiency in product and service
- Ability to foresee customer needs



R+D+I MANAGEMENT

- Manufacturing based on the R+D+I process
- Technological surveillance system

SUCCESS STORIES

At Prada Nargesa we believe that the testimony of our clients is our best guarantee, and that is why we like to expose some of the success stories that we have witnessed around the world:



Discover its location on the interactive map on our website!

DO YOU WANT TO PARTICIPATE?

Send an email to nargesa@nargesa.com including the following information and we will add you to our website

Company name

Testimonial name

Post in the Company

Country

Descriptive text

Photography with the machine

INDEX

1. MACHINE DETAILS	3
1.1. Machine identification details	3
1.2. Dimensions	3
1.3. Description of the machine	3
1.4. Machine part identification	4
1.5. General characteristics	5
1.6. Description of the guards	6
2. TRANSPORT AND STORAGE	7
2.1. Transport	7
2.2. Storage conditions	7
3. MAINTENANCE	8
3.1. Lubrication of moving parts	8
3.2. Machine greasing	8
3.3. Hydraulic oil change	9
3.4. Checkup of hydraulic installation	10
4. INSTALLATION AND START UP	11
4.1. Positioning the machine	11
4.2. Dimensions and work area	11
4.3. External permissible conditions	12
4.4. Instructions for connecting to the power supply	12
5. INSTRUCTIONS FOR USE	13
5.1. Basic principles for bending	13
5.2. Assembly of the rollers	13
5.3. User guide	14
5.3.1. Frequency Drive Notifications and Alarms	15
5.3.2. Manual Operating Mode	15
5.3.2.1. Creating a Sample Bar	19
5.3.3. Automatic operating mode	26
5.3.3.1. General Data	27
5.3.4. Program Management	31
5.3.5. Creating a new program	33
5.3.6. Production mode	38
5.3.7. Using materials and tools	41
5.3.8. Importing and exporting data	43
5.3.9. Alarm management	44
5.4. Working position	47

6. WARNINGS	49
6.1. Residual hazards	49
6.2. Counter-productive methods	49
6.3. Other recommendations	49
7. ASSEMBLY OF THE ROLLERS	50
7.1. Bending capacity	51
8. OPTIONAL ACCESSORIES	54

TECHNICAL ANNEX

1. MACHINE DETAILS

1.1. Machine identification details

Trademark	Nargesa
Type	Section bending machine
Model	MC550

1.2. Dimensions

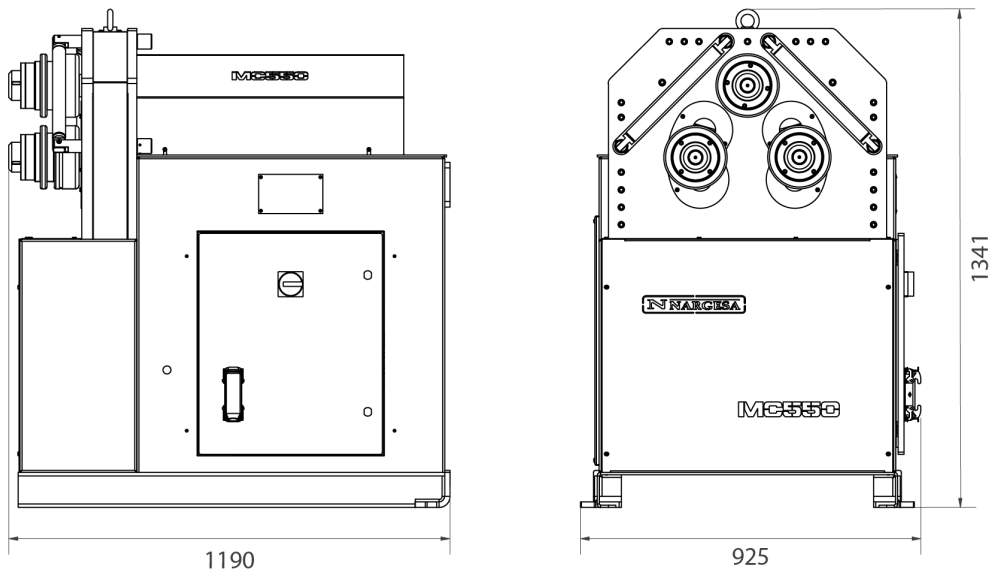

Picture 1. External dimensions of the MC550 bending machine

1.3. Description of the machine

The MC550 bending machine is a machine specifically designed for bending profiles, the majority of which are metal, with different thicknesses and configurations, such as solid profiles, pipes, T-profiles, angles...

The bending machine offers a set of standard tools, rollers, to allow the bending of profiles in a range of shapes and sizes.

Apart from the standard rollers, the manufacturer also offers different types of additional rollers to produce other types of bending, according to the configuration of the material to be handled, as well as specific rollers for work with stainless steel or aluminium, manufactured with * SUSTARIN for jobs in stainless steel or aluminum avoiding the material to be damaged or scratched.

* Sustarin: Polyoxymethylene, high resistance and high rigid crystalline thermoplastic, low friction and excellent dimensional stability

PRADA NARGESA S.L. is not liable for any damage that might occur due to misuse or failure by users to comply with the safety standards.

1.4. Machine part identification

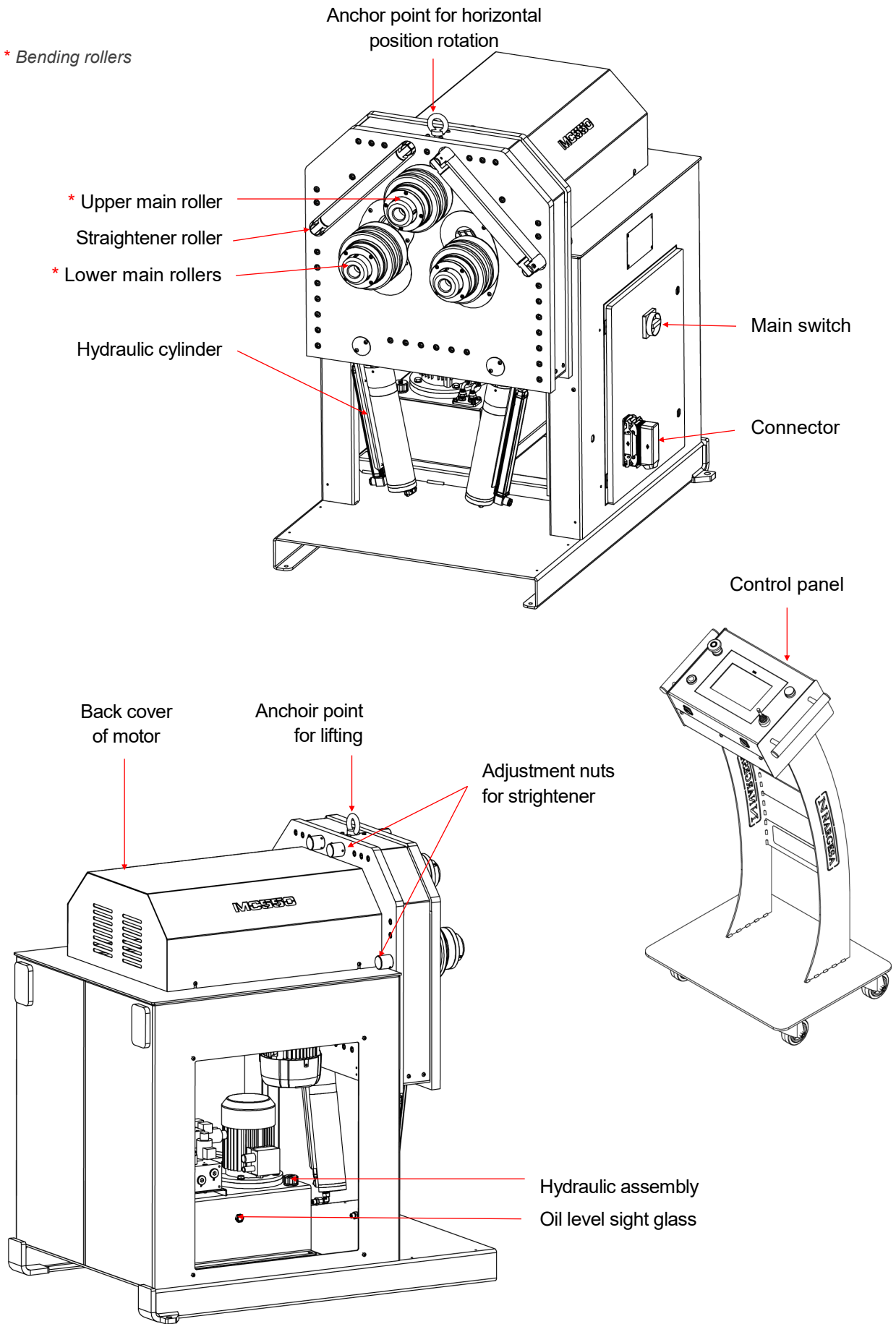



Figure 2. Nameplate

1.5. General characteristics

Motor power	1,5 Kw / 2 CV to 900r.p.m.
Intensity	7 A
Voltage supply	220V Single phase 50/60 Hz
Traction	3 rollers
Adjunstable rollers speed	From 3 to 8 r.p.m.
Diameter of rollers	170 mm
Diameter of axis	50 mm
Useful axis length	90 mm
Structure material	Sheet
Weight	840 Kg
Dimensions	925x1190x1341 mm

Hydraulic unit features

Motor power	0.75 Kw/1 CV a 1400 r.p.m.
Intensity	3.5 A
Pump	1,5 l/min
Work pressure	200 Kg/cm ² (20 MPa)

1.6. Description of the guards

The gear motor and all the gears that allow the operation of the machine are located under the main upper cover that protects the mechanisms.

Although the major mobile elements are protected by the upper cover, it is necessary to take special precautions during bending operations in order to avoid entrapment between the rollers and the piece being bent.

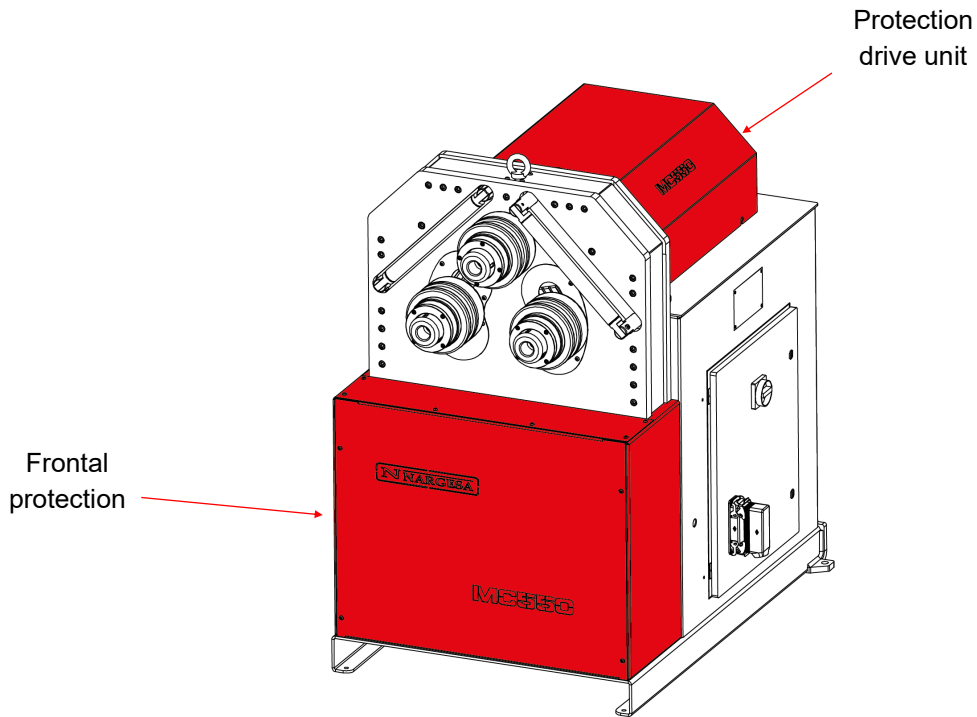

Figure 3. Mechanism protection guards

2. TRANSPORT AND STORAGE

2.1. Transport

There are two ways of carrying out the transportation of the machine:

- From the bottom, through the base of the machine, using a pallet jack or forklift as shown in the illustration. Never raise the machine more than 200 mm from the surface in order to prevent the risk of tipping
- From the top of the machine, from the anchor point designed for this purpose defined in figure 4, using a crane or forklift.

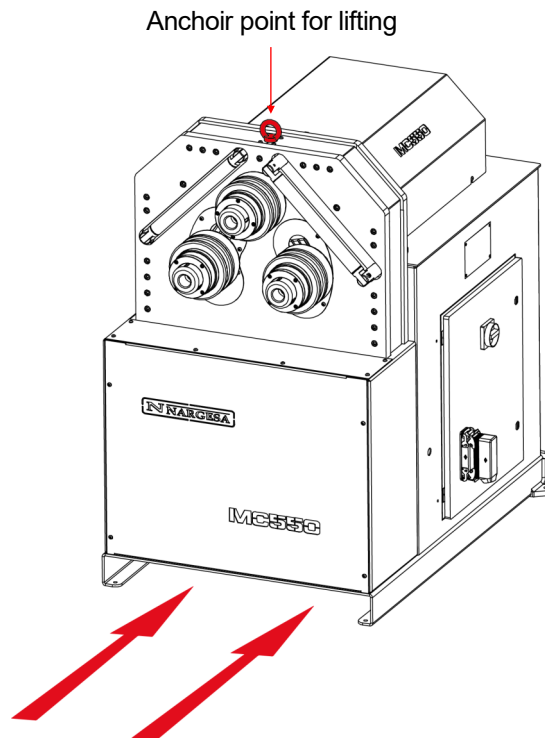

Figure 4. Transportation of the machine

2.2. Storage Conditions

The bending machine shouldn't be stored in a place that does not meet the following requirements:

- Humidity between 30% and 95%
- Temperature of -25 °C to 55 °C or 75 °C for periods not exceeding 24hrs
(remember that these temperatures are in storage conditions)
- Machines or heavy objects should not be stacked on top

3. MAINTENANCE

3.1. Lubrication of moving parts

It is advisable to keep clean the machine moving parts, whenever possible, in order to ensure a correct performance and thus make its useful life longer.

In order to lubricate the moving parts of the machine that require lubrication, it's recommended to follow the next instructions:

- Clean the surface to be lubricated with a cotton cloth or a soft rag that does not release any threads. To remove the accumulated grease and any possible residues that have become stuck to it.
- After cleaning, apply grease again on the surface with the help of a grease pump or a spatula for the pinions.
- Spread the grease evenly without creating excesses or clumps.
- Grease the machine periodically according to its use, at the same time the CNC of the machine will warn that it needs maintenance automatically.
- Lubricate the machine regularly, according to use.

** It is recommended to use lithium grease for the rollers N.850 EP-2.*

CAUTION: The "Emergency Stop" push button must be pressed and the machine brought to a stop in order to lubricate the machine".

3.2. Machine greasing

In order to the machine lubrication:

1. We place the rollers in the lower part.
2. We remove the back cover motor protection

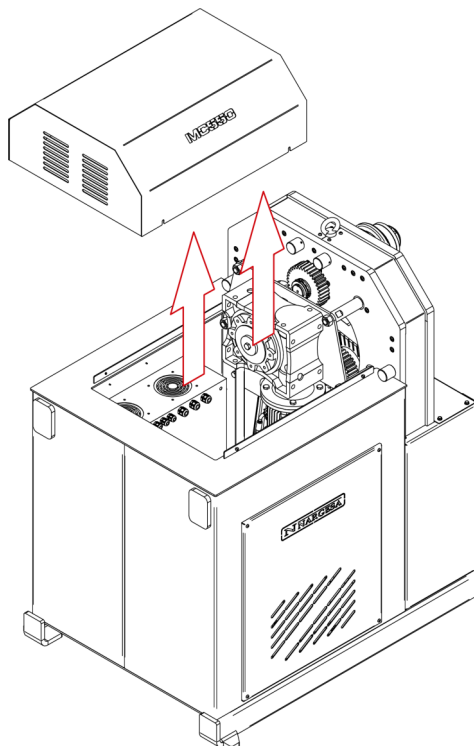

3. We apply grease in all the lubricators.

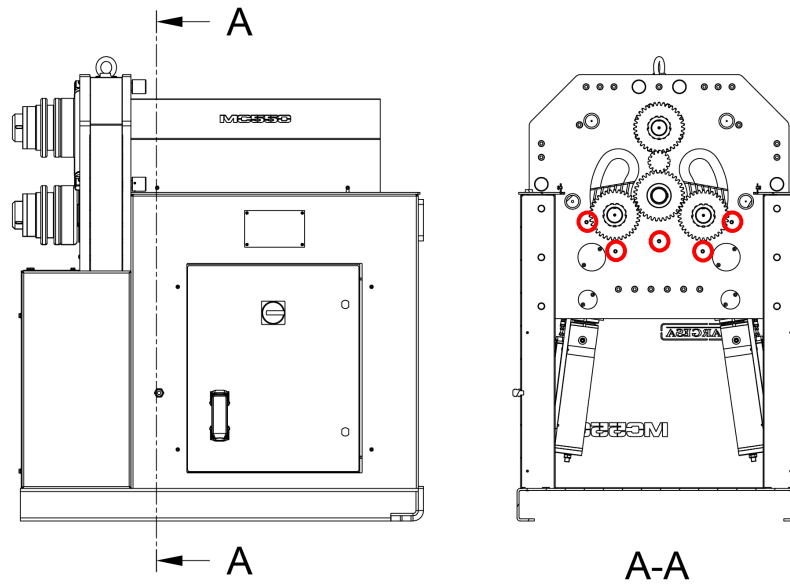

4. We clean and grease the pinions of the machine. After this we turn the rollers in both directions to ensure a good lubrication.

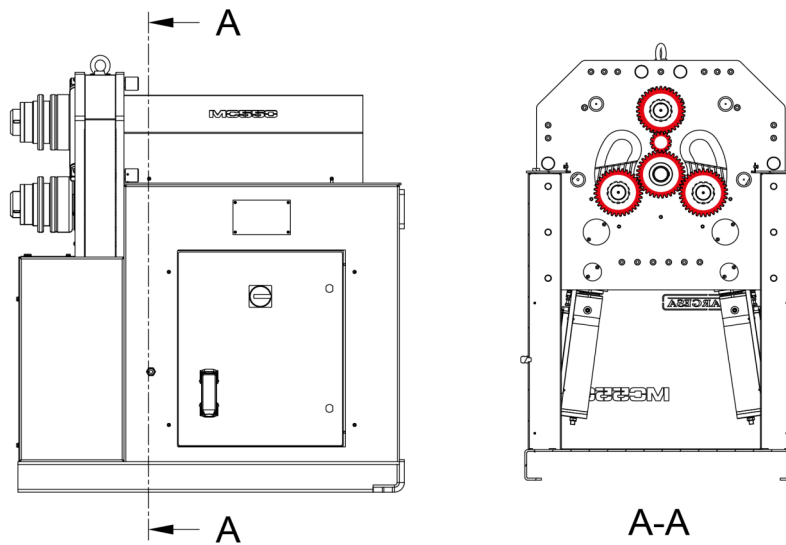

3.3. Hydraulic oil change

To replace the hydraulic oil, we recommend to follow the steps below:

- Check the oil level in the tank every 500 hours of use, checkup the oil level in the hydraulic tank located in the base inner side. In order to have a correct information about the oil level, the inner lower rollers must be in their lowest position.
- The oil cap is located at the top of the tank. If it is necessary to add oil, fill to the level of the sight glass at the front of the tank.

- Change the hydraulic oil in the tank every 2000 hours of work or every 5 years.
 - Remove the old oil in a tray and dispose of it at the nearest recycling point.
 - Fill the tank with new hydraulic oil to the level of the sight glass located at the front. The capacity of the tank is approximately 16 litres.
 - Return the hydraulic assembly to its location and secure it to the machine with the bolts.
- * We recommend the use of CEPESA HIDRÁULICO HM 68 hydraulic oil.*

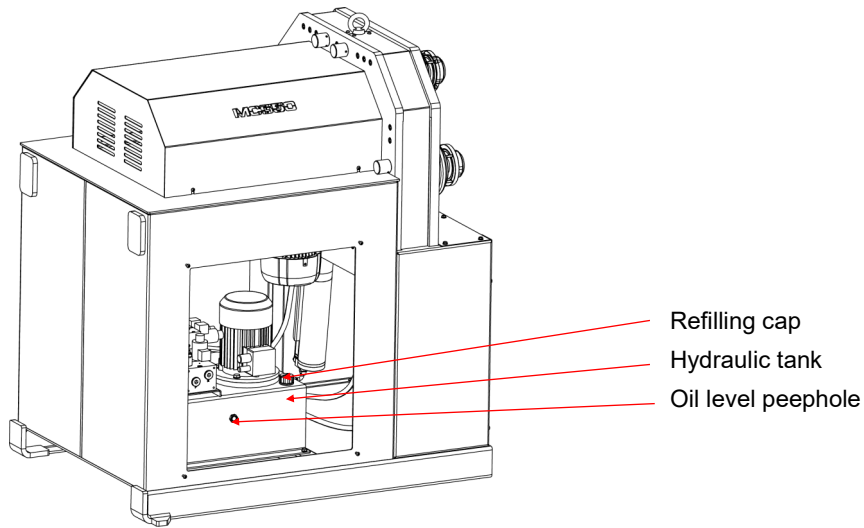

Identification of the components of the hydraulic set.

3.4. Checkup of hydraulic installation

Every 6 months we should make sure there is no arising oil leak in the hoses of the hydraulic circuit.

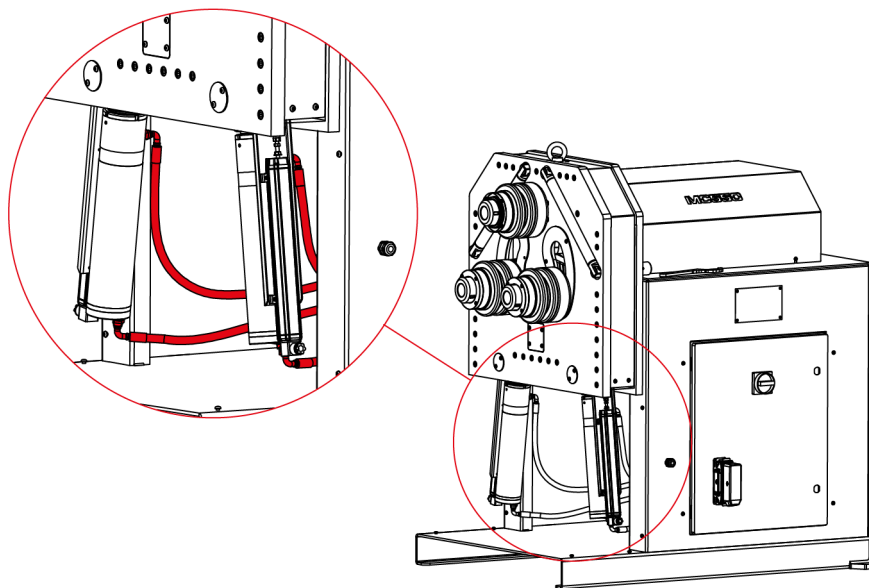

Hoses of hydraulic circuit.

4. INSTALLATION AND START UP

4.1. Positioning the machine

Locate the machine properly in order to avoid moving it; otherwise, follow the guidelines described in the paragraph transport (no. 2). Must be placed on a flat, level surface to prevent it vibrating and moving during bending operations.

It is optional to fix the machine by the four bolts since it is provided with a lower base or stand with four perforations as it's shown in Figure 5.

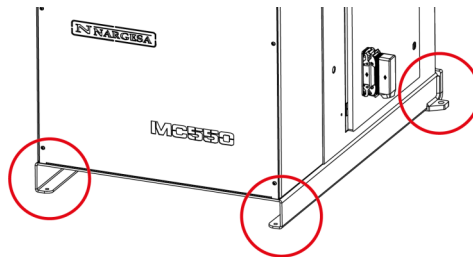

Figure 5. Anchor points of the machine

4.2. Dimensions and work area

The dimensions must be considered when the machine is being placed, the working area for the operator and the possible lengths of the parts to be worked.

The bending machine can be used by a single operator, who must be directly in the front of the machine to be able to handle the piece being bent with safety, and never on the side.

Prior to commencing the bending operation, with the machine shut down, the operator must adjust the bending rollers, adapting them to the material and the profile to be bent, as shown in paragraph 7, figure 14.

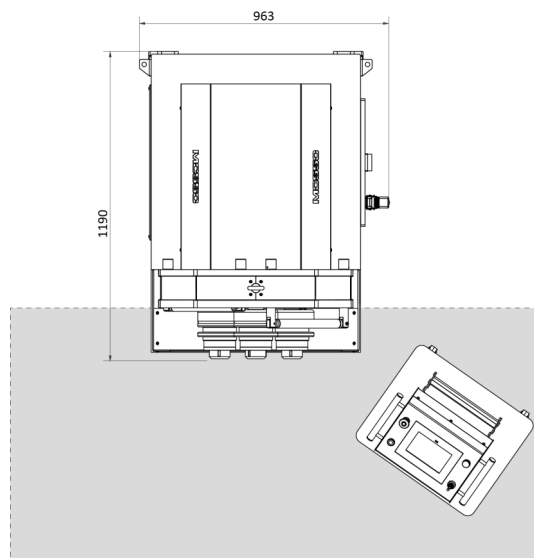

Figure 6. Operator's working area

4.3. External permissible conditions

It is advisable to work under the following atmospheric conditions:

- Room temperature between +5 °C and +40 °C without exceeding an average temperature of +35 °C within 24 hrs.
- Humidity between 30% and 90% without water condensation.

4.4 Instructions for connecting to the power supply

IMPORTANT: This machine must be connected to an electrical outlet with earthing contact.

IMPORTANT: This machine must be connected to a 220V socket with grounding contact. We supply the MC550 with two 230V / 400V three-phase motors of 1.5 Kw and 0.75Kw connected in triangle to connect to a 220V power source. It must be connected to a single power source and in the indicated power source. If the line voltage is not the one indicated, the inverters must be replaced if we have to change the voltage, because the frequency inverters of the machine ARE NOT MULTI VOLTAGE.

Before making any changes to the wiring of the motor bobbins or electrical panel, it is essential to check that the machine is not connected to any power source.

5. INSTRUCTIONS FOR USE

5.1. Bending principles

The bending of the different profiles and tubes is carried out by passing the material through the three driven rollers located at the front of the machine. Out of these 3 rollers, there is one fixed, and the remaining two are moveable. In this way and depending on the relative position of these three elements, it is possible to achieve the desired radius.

There is a touchscreen control panel to move the rollers mentioned as well as an orange button with a LED and a 4-way joystick. The button and joystick are each located on each side of the control panel and the functions are as follows:

Orange button: this button activates the hydraulic pump in energy savings eco mode. On the other hand, this button must be kept pressed down to position the X and Y axes when the target height is established using the touchscreen. In this case, the movement stops and the positioning is cancelled if the button is released before reaching the target axis position.

4-way joystick: Activating this joystick to the left or right turns the pull rollers to move the piece in the machine forward or backwards. On the other hand, moving this joystick up or down activates the hydraulic pump (only in energy savings eco mode) and the X and Y axes move negatively or positively, respectively.

This button also has a pilot light indicating when activation is possible. Thus, pressing it with the light off will not give any order to the machine, beyond activating the hydraulic pump if it is stopped (only in energy savings eco mode).

All the necessary information to give orders to the bending machine and receive information from it is done using the touchscreen on the control panel. Using this touchscreen, you can operate the machine manually or automatically by selecting the different pull rollers, creating and running programs, saving and loading programs, entering information on the bends (material, rollers used, heights, widths, thicknesses, radiuses, etc.). Plus, all the alarms and possible errors also appear on this interface which is highly useful for knowing what is happening at all times.

5.2. Assembly of the rollers

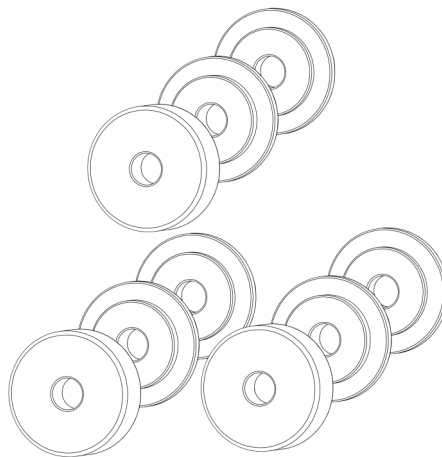

Figure 12. Position of the rollers in relation to the machine axes

5.3. User guide

A control panel with a multi-function touchscreen is used to operate the MC550 hydraulic pipe bender. The machine can also be controlled with a movement button and a four-way joystick for easier roller positioning. The control panel also features an emergency stop and a voltage indicator light.



1. Multi-purpose touchscreen
2. Movement button
3. Four-way joystick
4. Emergency stop
5. Voltage indicator light

This is largely the man/machine interface. However, reading the steps indicated in the following sections is recommended in order to be able to work with the machine safely and comfortably.

5.3.1. Frequency Drive Notifications and Alarms

Notifications and alarms from the two frequency drives that control the hydraulic pump and the motor that rotates the pull rollers may appear on screen when the physical limits for which the MC550 bending machine was designed are continuously exceeded.

The fact that they may appear in the top message bar on screen does not mean the machine is malfunctioning. It is just a warning not to exceed the mechanical capacities of the MC550 bending machine.

Given the origin, it is not possible to reset these notifications and alarms on the touchscreen which is simply informational in this case. Thus, to proceed correctly when correcting any of these situations, you need to access the electrical cabinet on the side of the machine. If you do so, you may locate the two frequency drives in the center of the electrical panel upon opening the door. (See annex - Electrical cabinet)

To reset these notifications and alarms, you must press the “STOP/RESET” button on the front of the drives.

5.3.2. Manual Operating Mode



After turning on the power to the machine (“Power On”), the manual mode graphic interface is displayed on screen.

The active operating mode is identified by the horizontal bar drawn below one of the two central images (automatic and manual) shown in the vertical menu in the right-hand side of the display.

The message bar at the top shows useful information and alarms so the user may know the machine status at all times.

The chosen language identification flag and the current time are shown at the top right.

The layout of the machine rollers along with the current height are shown in the middle of the graphic area above the speed control bar. Plus, the names of the axes enabled (X and Y, in the previous image) also appear as superscript in addition to directional arrows along with the signs “-” and “+” to enter the negative and positive directions of these axes.

The bottom of the screen is reserved for the active mode horizontal menu buttons.

In view of the message that appears at the top, the system must be reset in order to work appropriately. To do so, press the  button on the horizontal menu. If you do this, the message will disappear and the movement button indicator light on the front of the control panel will light up.

The bending machine is factory-set in eco energy savings mode to reduce consumption to a minimum when a period of inactivity is detected (5 minutes). This means the hydraulic pump will disconnect after a certain amount of time without being operated. This is normal. Thus, the hydraulic pump will continue to be stopped after the system is reset. Press the  icon on the horizontal menu at the bottom to start it simply activate the movement button on the control panel or activate the joystick upwards or downwards.

Of the three rollers arranged in pyramid form on the bender, only the position of the two bottom ones can be changed with the hydraulic activation of the two pistons. Thus, each one of them can be positioned in the exact place for optimal bending.

In manual mode, the active roller is highlighted in red. The one on the left (roller X) or the one on the right (roller Y) can be selected simply by pressing the corresponding drawing on the screen. Afterwards, to move it, just activate the position joystick up or down. During this action while the chosen roller moves physically, you can see on screen how the current height changes.

Plus, you can position either one of these two rollers (X and Y) in the desired position by pressing the height of the axis to be moved. Thus, for example, if you wish to place the X roller at a height equal to 60.0, then just press on the current height of the X axis (100.1) and a pop-up window will appear like the one shown below.



Enter the target height using the keypad. It's 60 in the example. Then, press the "SET" key on the screen to confirm and close the window.

If you do this, the graphic control interface will now show the following image. The target height you just entered is shown below the current height of the X axis roller as a subindex.







Now the machine is in the positioning mode for the X axis roller until the orange movement button located on the front of the control panel is pressed. Therefore, if you keep that button pressed down, the X axis roller will begin moving from the current height (100.1) to reach the target height established (60.0) at which time the positioning mode concludes (the target height on screen disappears).

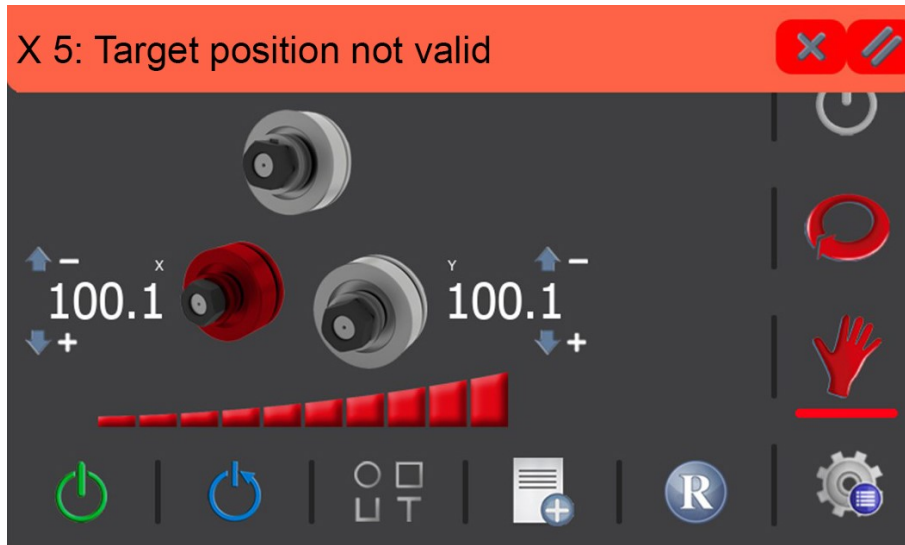

Once the positioning mode has begun for a roller, it can only be cancelled if the movement button is released before reaching the target height. Doing so will make the target height disappear from the graphic interface, returning to manual operating mode.



On the other hand, an alarm will appear on screen like the one shown below upon pressing the orange button to start the positioning for the selected roller if you enter a target height that is outside the range.



You may delete this alarm by pressing the  icon for the bar that set off the alarm or by closing the pop-up window with  and then accessing the alarm screen by pressing the  icon on the notification bar to see the alarm history.

Category	Code	Alarm	Date	08:33
Axes Alarms	5	X 5:Target position...	08:33:14 27/...	

From	To	Category			
27/9/2022	27/9/2022	All			

This shows the alarm history for the machine which can be filtered by date. As shown in the image, the active alarms appear in red. To delete them, you must press the  icon. To exit this screen and return to manual operating mode, you must press the  icon.

After this information on alarms and going back to the movement of the axes in manual operating mode, you must know that if you want more control over the position of each one of these rollers, you can use the speed control for help. This is shown on screen with this icon  under the rollers.

Reducing the speed is recommended for precise roller positioning. This is done by pressing on the desired segment of the aforementioned bar, which will then reflect the new percentage out of the total.



Besides the hydraulic movement of rollers X and Y which can change the pyramid-like triangle geometry of the machine for different bend radiuses, the MC550 allows synchronized rotation of the three pull rollers for optimal bending on the pieces to be produced.

To do so, presionar de nuevo el pulsador de movimiento con una mano y, con la otra, active the position joystick to the right or left. In this case, it doesn't matter which roller is selected. The three will rotate in the desired direction simultaneously.

Likewise, as seen with the movement of rollers X and Y upwards and debajo downwards, you can now use the speed bar to increase or reduce the rotation speed.

To do so, choose the right speed percentage as was done before by directly touching the speed bar on the screen and bend the piece using the pulsador de movimiento y el direccional joystick.

5.3.2.1. Creating a Sample Bar

Now that you know how manual mode works on the machine, you may want to know how to create a sample bar.

By definition and as the name indicates, a sample bar is simply a piece with different radiuses that you can create based on a specific profile of a certain material. The purpose is to provide you with useful information on the position of the rollers used to conform each one of the bend radiuses so you don't have to take the time again to achieve them when you must replicate them for future mass production.

To proceed appropriately, the first thing you have to do is define the general data for the profile you wish to bend. To do so, you must press the  icon that appears in the horizontal menu at the bottom of the manual mode screen.

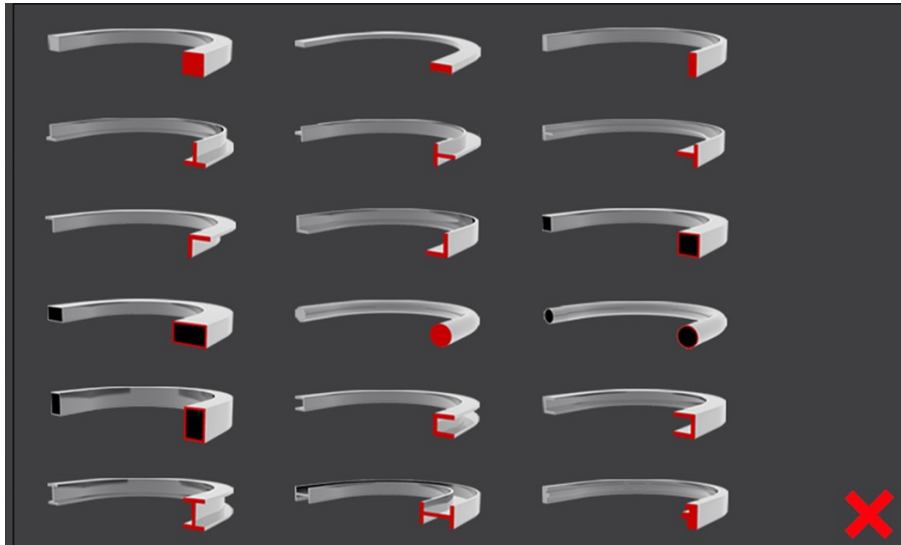

When doing so, a pop-up window appears showing the different profiles with which the machine can work. If you want to close it, just press the icon **X** that appears in the lower right corner of it, and the application will return to the manual screen.



If you now press the lower horizontal menu icon  again, the profile selection window appears again.

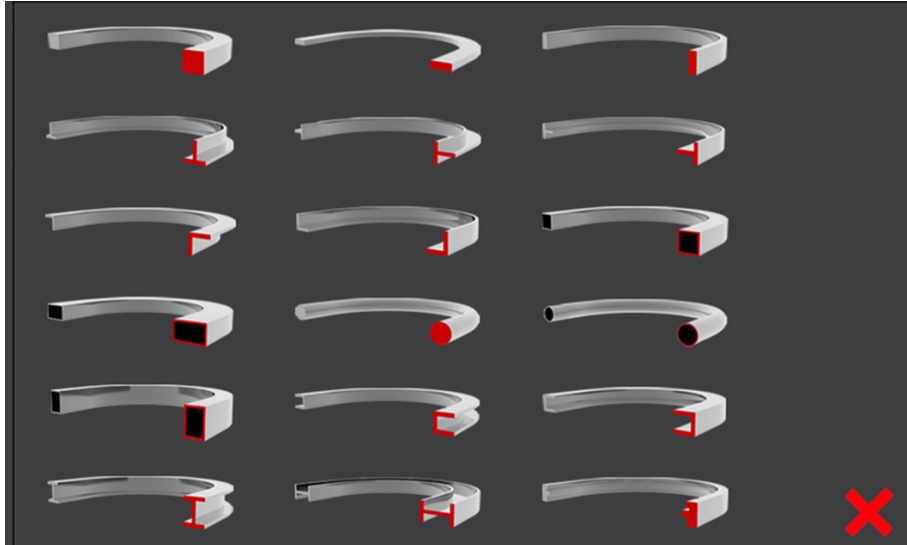

Now select the profile you are interested in using to create your sample bar. To do so, you just have to click on the image of it and the graphical interface will change, showing this other screen.

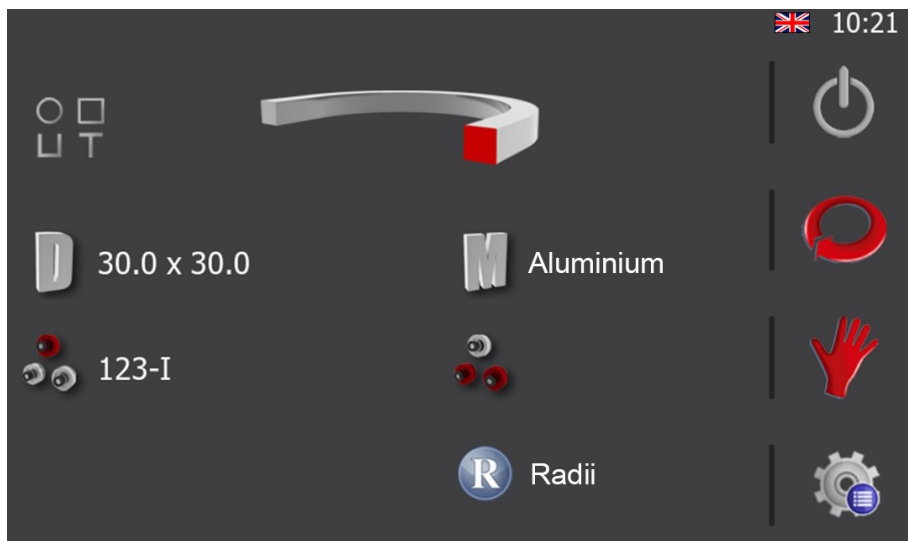

In the example, we have chosen a solid square profile. It appears at the top of the screen. Plus, we have assigned the dimensions 30.0 x 30.0. To do so, just press the  icon and fill in the corresponding fields as shown below.

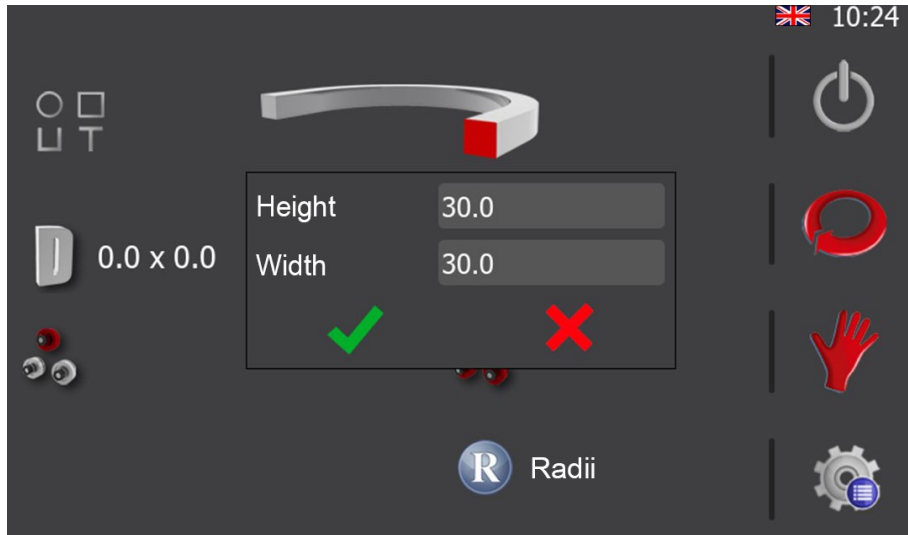

Once the profile dimensions have been defined to create the sample bar, select the material. To do so, press the  icon. If this is done, a pop-up window will open with a list of materials available so you can select the one you need.

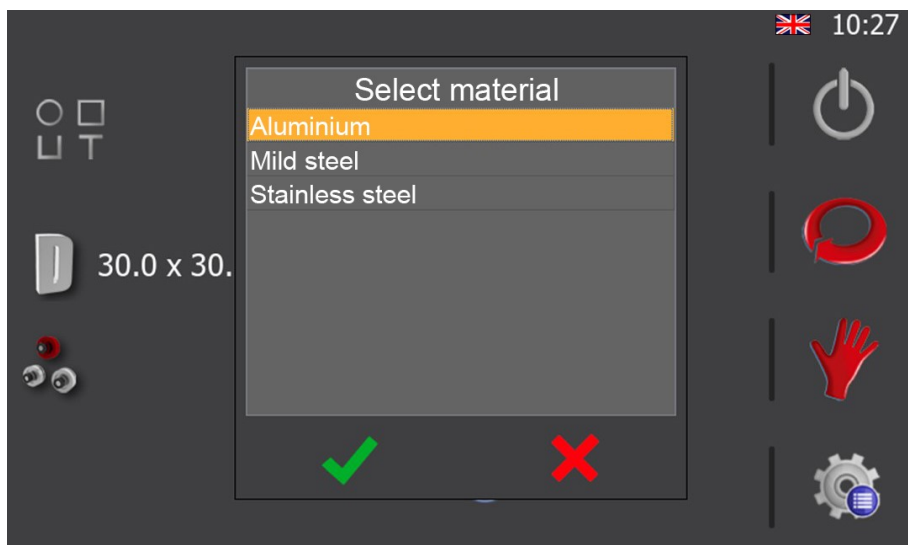

As soon as it has been chosen, accept to close the window.

Having reached this point, you now have the basic general data to create a sample bar. The position of the rollers in the three axes to conform the sample bar may also be defined if you wish; however, it is not essential. In any case, there is more information on this in later sections of this manual meaning you can wait for now.

Just press the  icon to return to the manual operating mode screen.

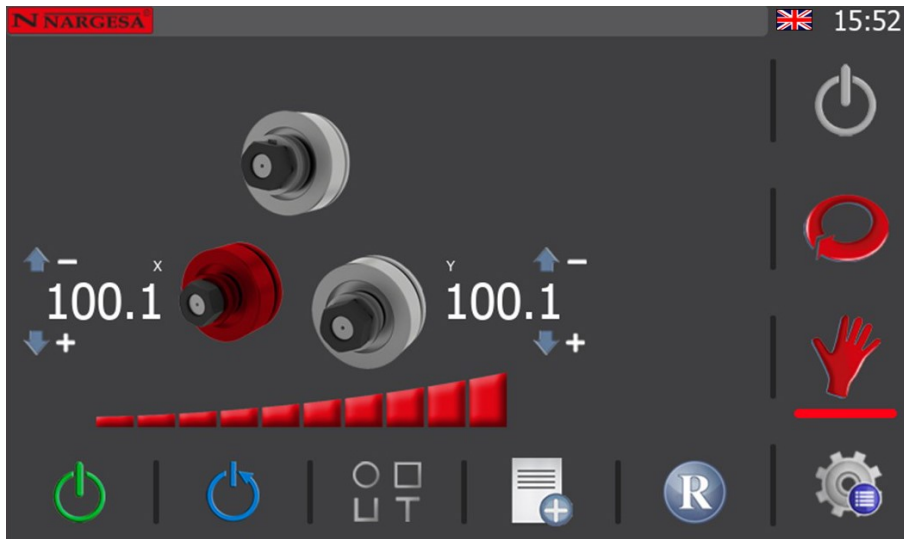

Now you can begin creating the sample bar. To do so, position each one of the rollers at a height so the profile to be worked can be loaded into the machine without any problems.

The rollers may be manually positioned by activating the front movement joystick on the control panel up or down. This action will cause the selected roller (highlighted in red on screen) to move in the chosen direction. You may observe how the actual height changes in real time as the movement occurs.

Likewise, for direct positioning, just press the actual height of the selected roller, enter the desired target height and press the orange movement button to execute it. As soon as the roller reaches the target height established, the direct positioning mode concludes and the target height will disappear.

Once the profile is loaded into the machine, you have to close the rollers to “clamp it” in order to proceed appropriately.

“Clamping” a profile with the bending machine is the same as saying it must move the X and Y rollers until the profile is firmly secured yet without deforming.

Now, given the profile to be worked is completely straight, the best thing to create a sample bar is to begin with large radiuses and end with small radiuses.

For example, imagine you wish to create a sample bar with 5 radiuses starting in the clamp position. The first thing you must do is close the rollers on the machine a little and make the bend by activating the joystick (to the left or right depending on the side through which the material enters) until the first radius has been created.

Then, press the  icon on the horizontal menu at the bottom of the screen in manual operating mode to add the first radius for the sample bar to our database. Upon doing so, a pop-up window like this one will appear.

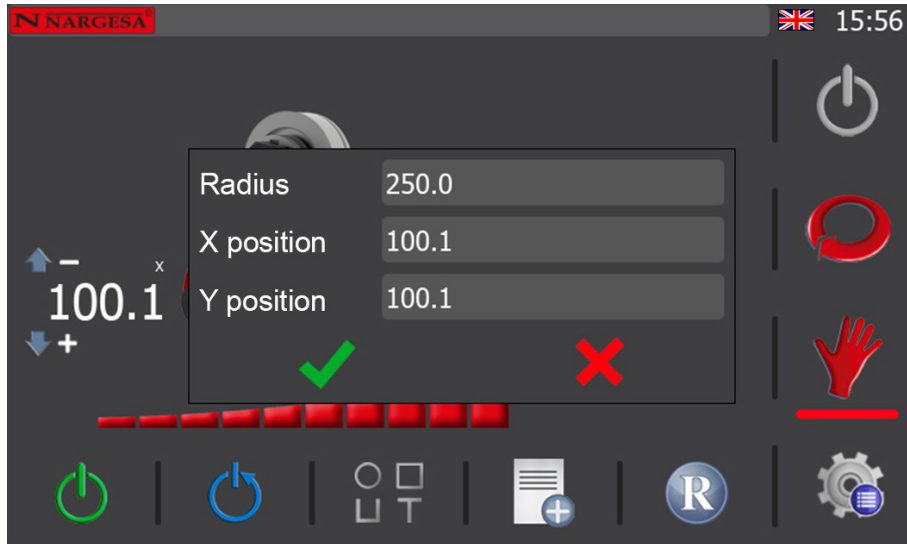

The position of the X and Y rollers will be captured automatically meaning the only thing you must now do is measure the radius by obtaining the first bend just created and enter that value in the “Radius” field in the prior image.

To measure the bend radius physically generated upon bending the profile you are working with, use a digital radius gauge. Remember that you must always measure the inner radius of the piece generated.

Therefore, once you have the value, press  and the radius will be saved in the database for later consultation.

At this point, you must close the rollers a bit more, do a second bend on the profile and measure the inner radius obtained again. Then, with the value measured, you must add another radius to the database.

Follow this procedure until the number of radiuses established as the target have been completed. In the example, we did five bends to get five radiuses.

To see the list of radiuses obtained with the sample bar, press the  icon on the horizontal menu at the bottom of the screen in manual operating mode. Upon doing so, the following information will be shown.

Radius	X position	Y position
100.0	75.0	75.1
150.0	80.0	80.0
175.0	85.0	84.9
200.0	90.0	90.0
250.0	100.0	100.1

This is the list of radiuses obtained for our sample bar. Obviously, the values obtained in this example do not have to correlate with yours. However, the list you will have obtained will also be organized from the smallest to the largest radius.

The radius values obtained as well as the positions of the X and Y axis rollers can be edited and deleted from this same screen using the corresponding icons on the horizontal menu at the bottom. Likewise, you can also add new radiuses to the list here by pressing the corresponding icon on the horizontal menu at the bottom.



To exit this screen and return to manual operating mode, just press the icon on the vertical menu to the right.

Now you have created a sample bar with different radiuses. Since you added them to the database in order to list them whenever you need to make a bend in the future with one of these radiuses on a profile just like the sample bar (remember the type of profile, dimensions and material are filters used to obtain the list of radiuses just like throughout the database), you may place the rollers in the adequate position to get the desired radius right away which saves valuable time.

Plus, since you can create as many sample bars as you wish for each of the different profiles and for different dimensions and materials, you will have a large database of radiuses over time by following this procedure to ease the production of pieces in the future.

In any case, you must remember one important thing. It is by no means possible to guarantee you will obtain the same radiuses as the first with the sample bar values from one batch to another of a certain profile, even when it is from the same manufacturer or, worse yet, when from different manufacturers. This can only be guaranteed for profiles of the same hardness and composition from the same batch and the same manufacturer. Therefore, it is best to check the result after conforming the first piece before doing any mass production.

5.3.3. Automatic Operating Mode



To access the automatic bender operating mode, just press the  icon on the vertical menu at the right of the screen.

A new program is created when you do this if you are not already working with a program. To begin, you must define the profile to be worked just like when you access the manual operating mode general data. Once the profile is chosen, you can complete the general data such as the dimensions and material or leave that information for later and begin creating a program by pressing the  icon on the vertical right menu again.

As can be seen in the image above, the information on the screen has slightly changed with respect to manual mode yet the graphic interface continues to be clear and intuitive.

Automatic operating mode allows you to create and save bending programs for mass production with the possibility of multiple radiuses on each piece. This operating mode is an evolution over the manual operating mode and, as seen below, it is also simple and powerful.

As can be seen at the bottom of the graphic interface, the active mode menu has changed. Now, in addition to the hydraulic pump control and system reset icons, there is an icon to save steps, one for general data and another for program management.



5.3.3.1. General Data

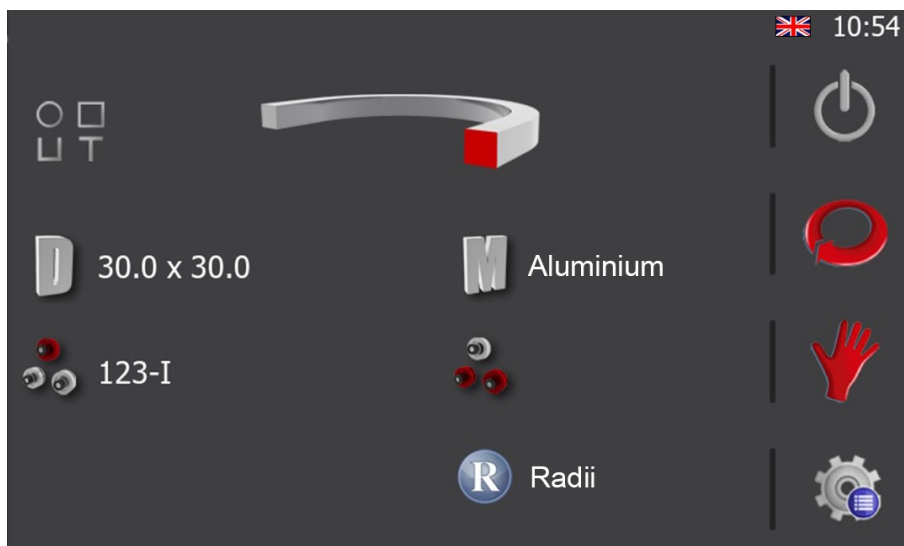

When bending a certain piece using a program, you need to know the type of profile used, the dimensions it had, the material, the position and rotation of each of the rollers used on the different axes in order to replicate the piece later.

This information can be added for each one of the programs used. To do so, press the  button on the horizontal menu on the automatic operation screen.



Now, you just need to complete the information by pressing on each of the items that appear on the screen. They are:

- 1.- The type of profile (top).
- 2.- Dimensions and material (middle).
- 3.- Rollers used and their position on each axis (bottom).
- 4.- Custom roller (data only visible for custom profiles).

By pressing on the profile image, or by pressing the icon  shown to its left, a miniature view of the different options available shows up on the screen. To select the desired profile, just click on the corresponding image or cancel the selection by clicking on the icon 

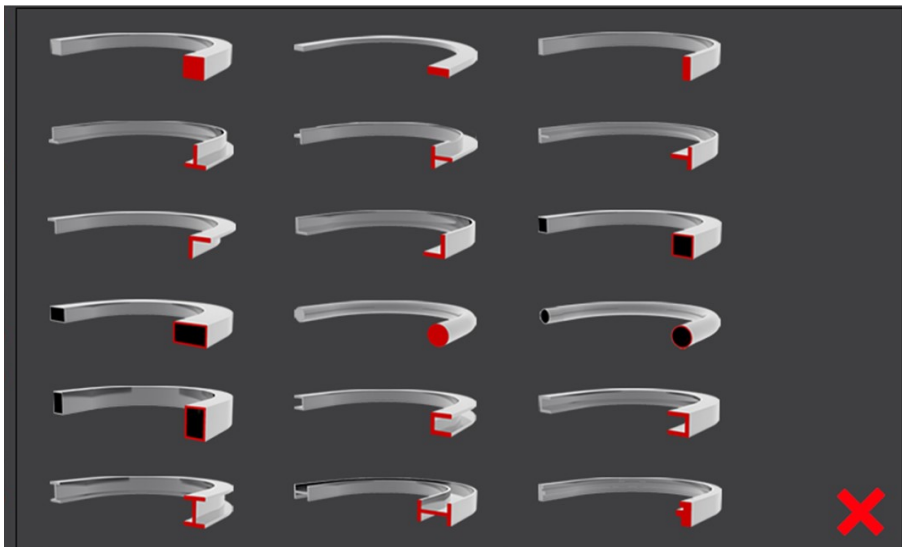

Remember the following data may vary based on the type of profile chosen. In other words, to define the dimensions when selecting a solid square profile, you must enter height and width. To define the dimensions when selecting a hollow square profile, however, you must enter height, width and thickness. Likewise, you must enter the diameter if you choose round profiles.

As can be observed, it is a dynamic information menu which adapts in real time to the choices you make.

A screen like the one below will appear when you press the dimensions icon. To complete the data, you only need to press on each one of the textboxes and use the virtual keyboard that appears to enter the correct values.



Upon pressing the material icon, you'll see a list from which you can choose the material.

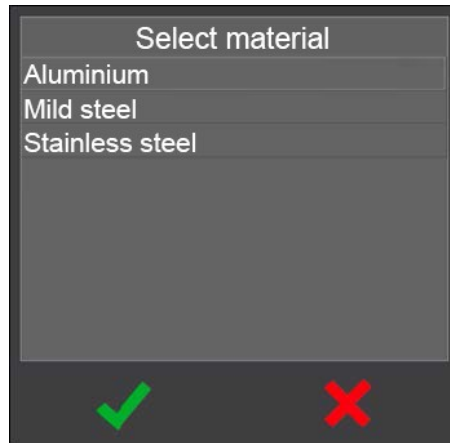

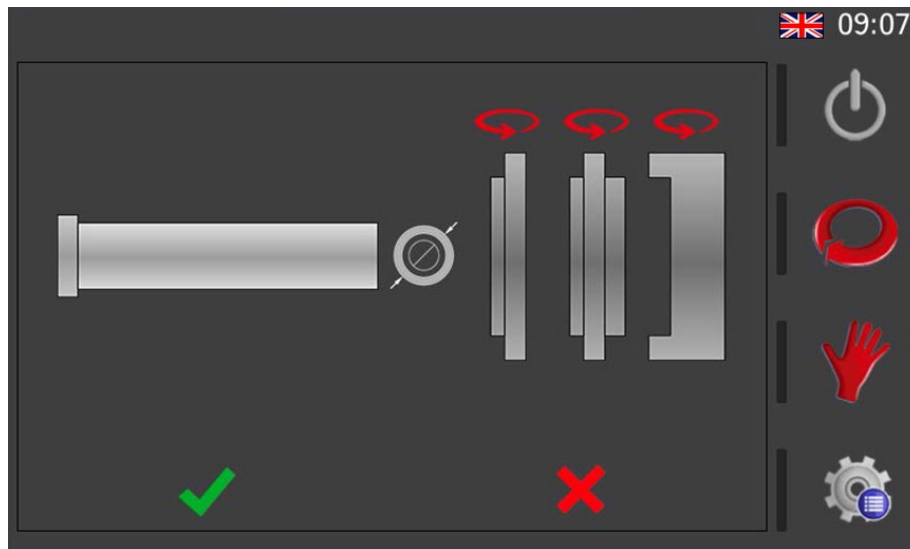

Choosing the rollers is just as intuitive. The following graphic will appear upon selecting the top or bottom axis.



Using this interface, you can flip each one of the rollers (by pressing the arrow above them) and place them on the axis (by pressing the desired roller). Keep in mind that the order in which you press each one of the rollers will be the order in which they will be inserted on the axis.

Also, for flat profiles, you can select whether you want to work with the inside or outside diameter of the roll. That is, if to bend the corresponding profile it is going to support it on the innermost part of the roller (internal diameter), or on the outermost part of the roller (external diameter)

To do so, simply press the icon  (outer diameter), and you'll see how it changes into this other one  (inner diameter). If you press again, the icons changes again.

As already mentioned, you'll see a different picture of the rollers if you selected a round profile or a custom profile in a prior step since it is a dynamic information menu.

Press the OK button when the configuration is correct and you will have completed one axis. By repeating these

steps, you may define the roller configuration for the remaining axis.

Besides information referring to the profile itself, the dimensions and the material as well as the configuration of the rollers in each one of the axes, this radius information  icon appears on this general data screen.

The purpose is to provide access to the radius management screen shown below.

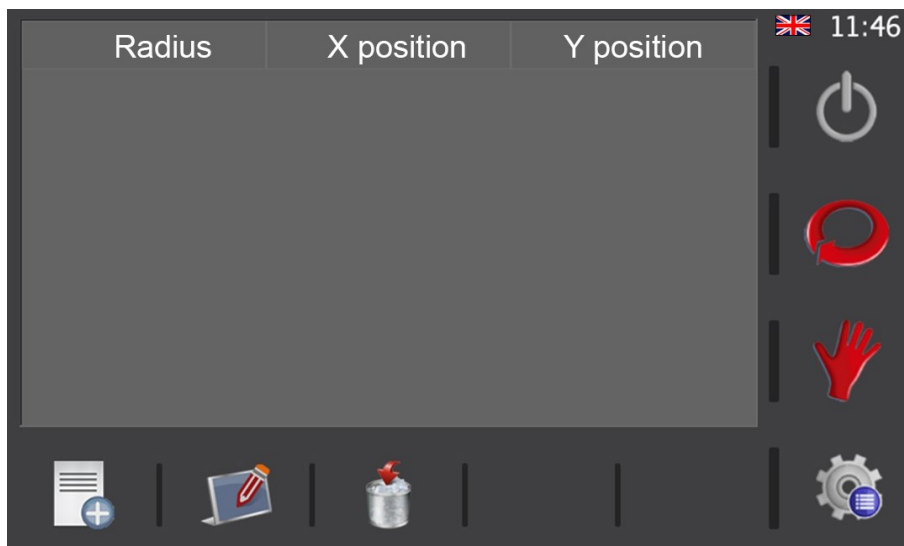

Based on the three icons that appear in the horizontal menu below, new radiuses can be added to the database, the existing radiuses may be edited and they may even be deleted if necessary.



Likewise, if you have already created a list of radiuses based on a sample sweep for a certain profile with specific dimensions and specific material, the corresponding ones will appear on this screen. Thus, you can also consult the radiuses that exist in the application database here.

After completing all the information necessary and checking whether the radius information is accurate, you can return to the manual mode or automatic mode operating screen by pressing on the corresponding icons in the vertical menu.



Manual mode



Automatic mode

5.3.4. Program Management

Since many jobs currently need to be done with the same machine, the profile bender allows you to save and load all the programs used with it. Thus, repeating pieces made previously is as easy as loading the corresponding program and switching to production mode.

The name of the program being used will appear at the top left of the screen (in automatic mode) and sometimes the “*” indicator will be displayed at the beginning. This indicator warns the operator that data has been modified yet not saved to the hard drive. In other words, you can load a program and modify it to make an isolated piece yet not save it. Or you can save it if you want to keep the change. It's your decision.

To save the program, you must press on the name of the program (text at the top left) and a virtual keyboard will appear to enter a name if it hadn't ever been saved. If, on the contrary, you had already chosen a name previously, it will be saved on the hard drive and the “*” indicator will disappear upon pressing the name.





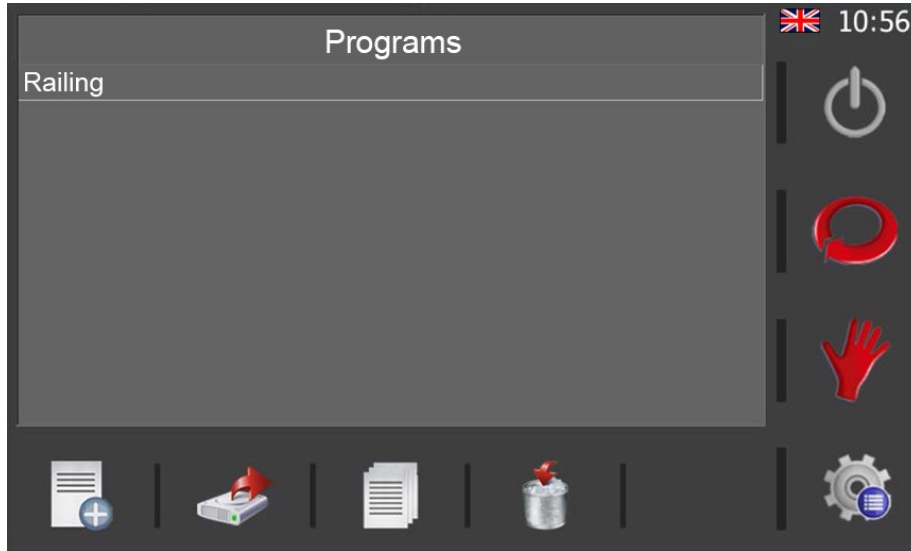

You can save your program with these basic steps but you'll need to create a new program at some point or load a previously created program. This function can be found by pressing the  icon in the horizontal menu giving you access to the program management screen.

You may also access the program management screen by pressing on the menu  icon (at the bottom right of the screen) and then selecting the icon .



By using the horizontal menu here, you can do the following:

-  Create a new program
-  Load an existing program
-  Save a program as
-  Delete a program

5.3.5. Creating a New Program

All of the programs created are made up of steps. A program can have as many steps as are necessary to generate the geometric shape required based on the piece curving.



The first step in a program is known as the “unloading step”. As the name indicates, this is when the position of the rollers allows you to remove the piece created without it colliding with the rollers. Therefore, to create it, you just have to position the rollers on the X and Y axes at a height that will then make it possible to remove the finished piece once it is created.

You learned to move the X and Y axis rollers in manual operating mode using the directional joystick as well as direct positioning. Here, you can use any of these methods to correctly position the rollers. Thus, once you are satisfied, just press the  icon on the horizontal menu to save the current step. Accept the confirmation message and continue.



The second step in a program is known as the “loading step”. This is when the position of the bender rollers allows you to insert the material to be worked using the machine.

To create it, just place the X and Y rollers in a position that allows the profile or pipe to be bent to enter the machine without colliding with the upper roller. You learned how to move both rollers in the section on the manual operating mode. You follow the same procedure here.

So, once both rollers (X and Y) are positioned in the “loading” position, this step can be saved by pressing the  icon on the horizontal menu. Accept the confirmation message and continue.



Upon doing so, the application creates a third step for the program. This step is known as the “clamping step”, which is when the material loaded in the machine and ready for processing is firmly secured between the upper roller and the two bottom rollers.

As a result, rollers X and Y must be moved to define a good clamping step so the profile or pipe to be worked is secured with the three rollers without deforming it.

Once that has been done, save the current step as you learned how to do for the previous step. Accept the confirmation message and continue.

You must be aware that any program created with our MC550 bending machine absolutely requires these three steps before bending can begin. The reason is to provide you, as the user, with a comfortable and safe operating mode all while guaranteeing the result obtained for all pieces of the same type of profile or pipe will be excellent for exceptional repeatability throughout the entire series.



Now, with the material secured in the machine, it can be placed in position to begin bending by making the rollers rotate towards the left or right as learned in the section on the manual operating mode.

Once the profile or pipe to be processed is in the required position, choose which of the two rollers (X or Y) you want to move to begin making the desired bend. Then, activate the directional joystick upwards or downwards or directly position the selected roller to place it in the position to create the bend radius entry. As soon as you are satisfied with the position reached (remember the current height is shown on screen at all times), you can save the step as you did before. Accept the confirmation message and it will be ready to create your first bend radius.



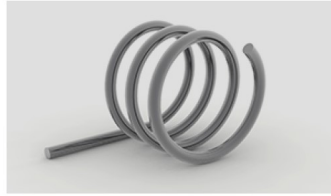

Having reached this point, turn the rollers to the right or left as desired to create the bend in one direction or another. Firmly secured in the machine and with the beginning of the bend radius already created, the profile or pipe to be processed will begin to be bent following the radius generated based on the geometry defined by the three pull rollers.

If you are satisfied with the resulting piece, you can move on to production. If you are not, adjust the X and Y rollers again to get a larger or smaller bend radius as required.

Remember that a program does not have to create just one bend radius in the piece to be processed. You are the one who decides how many you want to create. And this gives rise to end pieces of varying geometric complexity. Obviously the more complex the result must be, the more steps you must create with the program to achieve it. You just have to learn how to operate this tool, which is as useful as it is powerful, to create pieces as surprising as these.





Plus, remember that you can check the steps already saved in the program being created at any time. To do so, just press the  icon in the middle of the automatic operating mode screen.

Step	X	Y	 16:13
1	100.1	100.1	
2	90.0	90.0	
3	80.0	80.0	
4	75.0		

This information can be quite useful when creating a program so you can re-position the rollers in a certain way; if you want the piece to have a straight section after a bend, for example.



In any case, it's best to experiment and do some trial and error to get the most out of this useful function offered by our bending machine software.

Finally, just press the  icon on the vertical menu at the right of the application when you wish to return to the automatic mode screen.

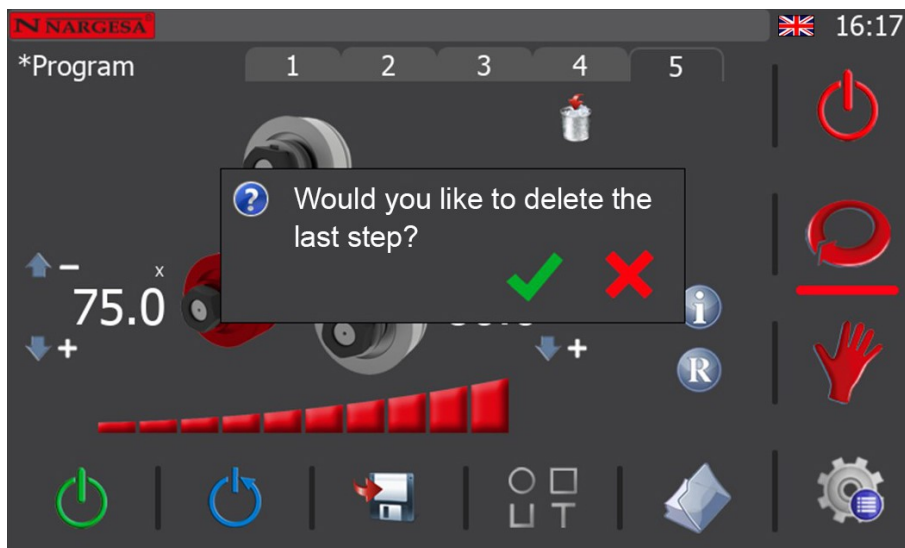
In addition to everything mentioned so far regarding program management, you should know that you also have the possibility of deleting the last saved step. To do so, just press the icon 



As you can see, a confirmation message for the deletion of the last saved step appears on the screen.

If you cancel by pressing the  button, the last saved step of the program will not be deleted. On the contrary, if you accept, by pressing the  button, the last saved step of the program will be deleted.

In this way, step by step, you can eliminate all the steps of the created program until there are none left.

Obviously, the purpose of the delete last saved step option of a program is to allow you to correct specific errors that you have made during the creation of a program. Therefore, as soon as you realize that you have made a mistake, correct it in this way, so that you do not have to eliminate more steps than are merely necessary.

At this point, the only thing left to say is that, if at any time you wish to access the radio information for the selected profile and material, all you have to do is press the icon  that appears on the screen. This can be useful to you while creating the steps of a program to achieve a certain radius (existing in the database or close to an existing one), speeding up the bending process based on your requirements.

5.3.6. Production Mode

To enter production mode, press the  icon on the vertical menu. If you do so, the program you were creating will be finished.



A finished program is a program suitable for the mass production of parts. That is, a program with the appropriate steps to generate the desired geometry for a certain profile of a certain material. However, despite the qualifier "finished", which is synonymous with a program suitable for production, there is the possibility of eliminating existing steps (not the unload step, the load step, or the clamp step, which must exist by default). imperatively in a finished program), as well as the option of making corrections and adjustments to the coordinates of the axes to obtain an ideal result

Furthermore, to complement these options, there is also the possibility to continue adding steps to the end of a finished program, making it editable again.

So if you want to make last minute corrections when you are in production, such as removing steps, adjusting dimensions, or adding steps to the end of the program, you can return to the program editing mode by bien pressing the  icon on the vertical menu.

You will then be able to edit the currently loaded finished program.



You can access any of the steps comprising the program by directly pressing the corresponding tab (the program is in step 1 in the image shown) or use the navigation arrows   to do so.

Remember you can only correct the height of the rollers assigned a height. In the example shown in the previous figure, you can correct the X axis and the Y axis.

To proceed, just press on the height you wish to change. Upon doing so, a window will open where you can enter the new height.

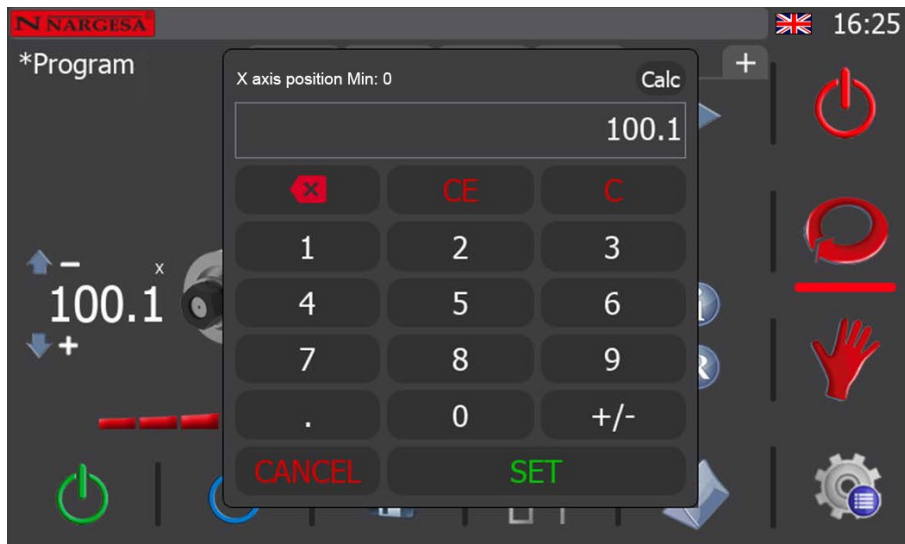

Use the numerical keyboard to make the adjustment to the height of the chosen axis. To confirm, press the “SET” key.

As soon as you finish making the adjustments or corrections in the different steps (if necessary to finish refining the resulting piece), you can return to production mode and begin the series.

On the other hand, if you want to delete an existing step, hover over it by pressing its tab, or by using the navigation arrows. Then press the icon , and accept the confirmation message. Doing so will remove the selected step from the finished program.



However, remember that you cannot remove either the unload step, the load step, or the clamp step from a finished program, as their existence is imperative.

You can also continue adding steps to the end of a completed program if you wish. To do so, just press the tab 

In this case, the finished program goes back to editing, as can be seen in the following screen.



Now, in the new step that is added to the end of those already existing in the program (the fifth in the case of the example that concerns us), you can edit the position of the desired axis. To do so, you must proceed as you have already learned to do during the creation of the steps of a program, using the joystick or performing a direct positioning of said axis. Then, to save this step, press the icon  from the lower horizontal menu. Accept the confirmation message and continue creating more steps, if desired, or go into production mode when ready, ending the program.

To do so, remember to press the  icon in the vertical menu at the right. After doing this, you'll see how it changes to this 

Now that you are back in production mode, using the navigation keys, or by clicking directly on the step tab, go to the second one (we go to the second step since this is the material loading step). You are now ready to start producing.

Thus, as soon as you press the movement button, the hydraulic pump will start and the rollers will move to the defined level. The X roller always moves first and then the Y roller. When both axes reach the defined position, the movement stops and the button can be released. This is the loading step. Therefore, you can now load the profile or tube to be bent into the machine. Now go to step 2. Press the button until the rollers reach the defined size and you will have completed the clamping step. If you wish, move the profile or tube to be bent forward or backward by moving the joystick to the left or right.

Go to step 4 of the program. Activate the movement button and the axis whose coordinate is defined will be placed in position creating the curve input for the part. Make the bend by turning the rollers to the left or right as appropriate. Continue executing the remaining program steps until the part is complete.

As soon as you are finished, to remove the already formed part, select step 1 of the program (unload step) and run it as you have learned to do. Keep in mind that the machine, by placing the X and Y rollers in position, will release the part. Be careful to prevent it from falling.

5.3.7. Using Materials and Tools

As already explained in the “General Data” section, you can define additional information for a program. This function makes it possible to replicate pieces always using the same conditions (profile type, material, dimensions, position and roller direction, etc.).



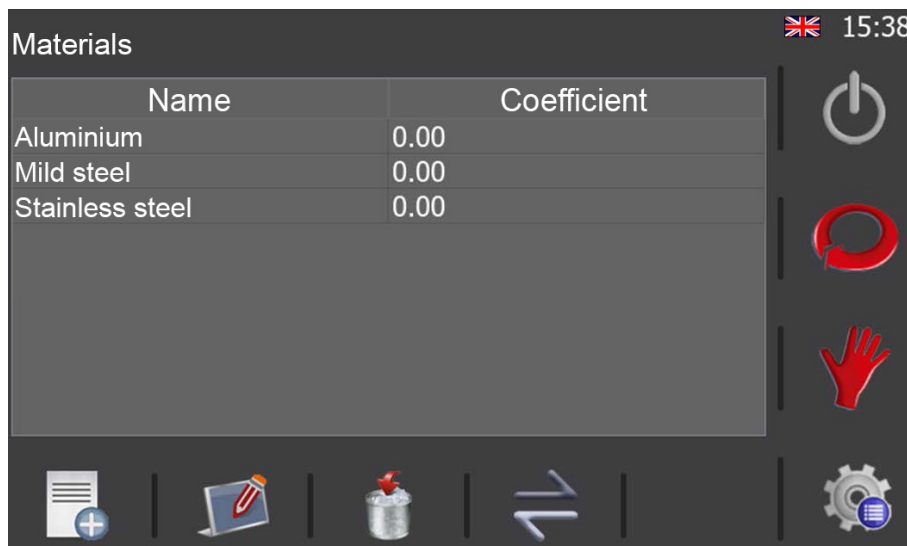

Even though the machine is supplied with a database including the most common materials and tools, each customer has their own needs. This means you may need to create new materials or define new rollers to adapt to all situations.

To do so, go to the general menu by pressing the  icon that is always found at the bottom right-hand of the screen.

Once in this menu, press the  icon for access to the material management screen.



By using the horizontal menu on this screen, you can do the following:

-  Create a new material
-  Edit materials
-  Delete materials
-  Switch to the tool management screen (custom rollers)

For clarification purposes, remember that each one of the materials is defined by a descriptive name plus a coefficient representing its physical resistance.

In standard materials you can edit the coefficient, but not the name. Besides, you cannot delete them either because they are an essential part of the material database.

On the other hand, you can create all the additional materials you need, with any coefficient and with any name, as long as this latter does not already exist in the database.



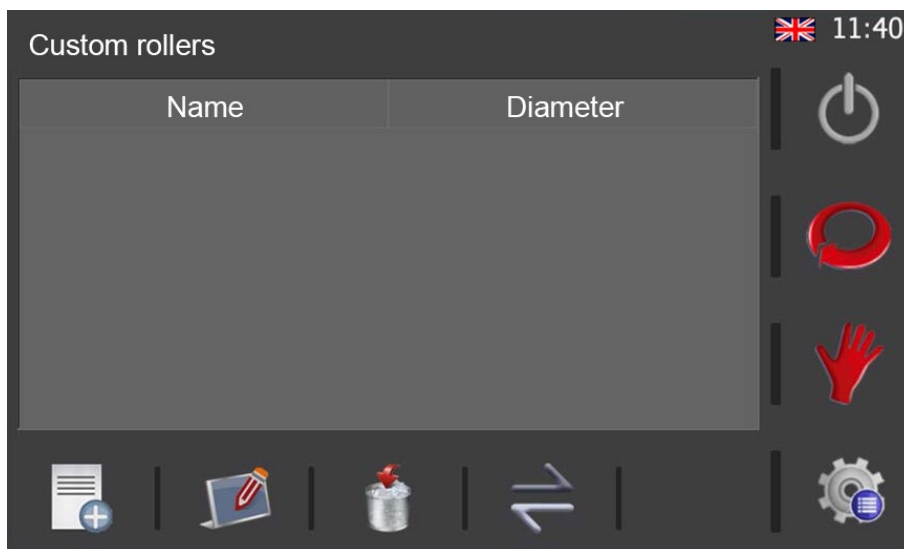

Name	Aluminium
Coefficient	0.00
	✓ ✗

The bending software is supplied with a very complete tool database as it includes the rollers for flat profiles which come standard with the machine and all other possible rollers for round profiles we normally manufacture or can manufacture upon request. However, each customer is different and this variety means they need to be able to define specific tools or custom rollers.

This is the custom roller management screen:



Just like with the material management screen, the following actions are possible if you press the icons in the horizontal menu:

-  Create a new custom roller
-  Edit an already-existing custom roller
-  Delete a custom roller
-  Switch to the material management screen



Remember that each custom roller is defined here with a descriptive name plus an effective diameter.

Name	Roller1
Diameter	0.00
	✓ ✗

5.3.8. Importing and Exporting Data

The same software that runs on the physical machine can be run on a PC with a Windows operating system. This makes it possible to get the operators and technicians who will intervene in the development and production process familiar with the environment they will later use. Si However, remember that it's simply a simulation on a PC and some functions are not available unless done on the machine in question.

Having said this, it is possible to create materials, tools or radiuses on the PC. However, since you won't want to replicate all that work again on the actual machine, you have the "Importing and Exporting Data" screen.

To access it, you must first press the  icon at the bottom right-hand of the screen and then on the  icon in the menu that appears.

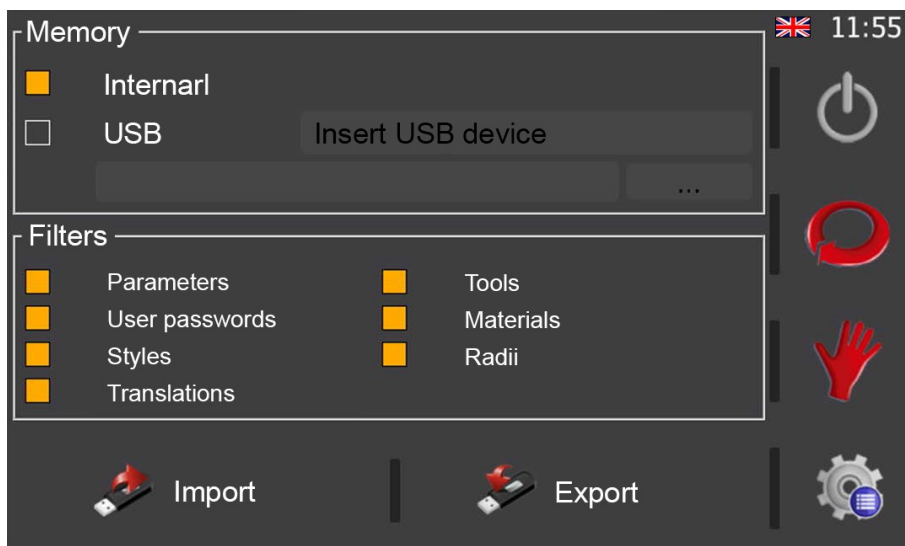

This screen allows you to export the data created on the PC and import them into the physical machine. Or vice versa. In other words, data can be exported from the machine and imported to the PC for the desired purpose if an operator has created new materials, tools or radiuses on the machine.

If you pay attention to the middle of the screen, you'll see how the data to be exported or imported is decided under the "Filters" section. Even though only transferring tools, materials and radiuses has been mentioned thus far, there are also other options. They are highly important as they allow you to make backup copies of the machine configuration parameters, add new styles to personalize the look of the software and even define new passwords and add other languages.

All of these data are imported and/or exported using a USB memory stick which can be inserted into the corresponding connector on the control panel. It is also of vital importance to emphasize at this point that you can export and/or import data to the system's internal memory. This allows you to have a backup copy on the machine itself which can be recovered whenever necessary.

5.3.9. Alarm Management

The user interface on the bender is not only capable of sending orders to the machine, but it can also show a large quantity of highly useful information to know what is happening at all times.

For example, you will see the following pop-up window clearly indicating an emergency stop if you press the safety button on the control panel.

This pop-up window can be bothersome in certain situations. Therefore, you can close it even though the alarm is still active. To do so, just press the **X** button.



Remember that this window will also automatically close if the alarm disappears. In other words, in line with this example, this window will disappear if you unblock the safety button and press the reset button  (always necessary after an alarm goes off).

The question now is how to tell if the system has an activated alarm. You just look to see if the  icon appears at the right of the message bar at the top of the screen.

The presence of this icon indicates an active alarm status. To find out exactly what is happening or, in other words, what situation is producing the alarm statuses, just press the  icon.

The following screen will appear upon doing this:



Here's a list of all the alarms that have gone off to date and all those which are still active are marked in red. To delete the alarms, they need to be corrected by unblocking the emergency stop button, for example. However, other alarms can be reset by simply pressing the  icon.

This resets the active alarms that require no other action, making the system ready to be reset. So, when you return to manual mode, automatic mode or production mode, just press the  icon to continue working normally.



On the other hand, remember that any notifications and alarms from the two frequency drives controlling the hydraulic pump motor and pull roller rotation motor will remain active (in red) on this list even if you try to delete them by pressing the  icon.

This is due to the origin, which only implies they may be deleted by directly accessing the frequency drive that notified the control software. Thus, in order to proceed correctly, you must access the electrical panel as you learned to do under the “Frequency Drive Notifications and Alarms” section. Open the door and press the STOP/RESET button on the corresponding frequency drive.

If you following this procedure, press the  icon from the control software to reset the system and continue operating as normal.

In any case, remember once again that alarms and notifications from the frequency drives are not common unless the mechanical capacities for which the bender was designed have been exceeded. In other words, they only appear to prevent the machine from suffering irreversible damage that may affect its operation.

Besides these alarms, the bending machine is equipped with a greasing alarm that appears upon 850 hours of operation which in the metal industry equals a period of a half a year. Before continuing to operate, the moving parts on the machine such as the pinions that transmit the movement to the axles must be greased.

Once greased adequately, delete the alarm in order to continue working. To do so, access the menu by pressing the  icon in the lower right corner of the application. Now, from here, you must press the  icon providing access to the alarm management page.

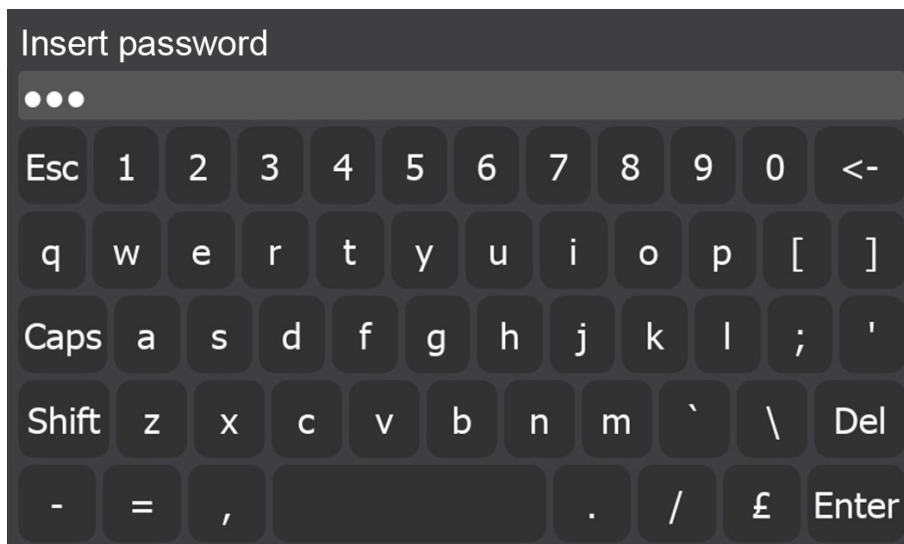

As you can see, you will be asked to enter a password to guarantee you have permission to access it. The password you must enter is “nargesa”. Thus, as soon as you have entered it, press the “Enter” key and the following page will open.



Now, to delete the greasing alarm, just press the  icon, return to manual, automatic or production operating mode and reset the system by pressing the  icon.

The greasing alarm will re-appear repeatedly every 850 operating hours so you will have to follow the procedure described many other times. This will ensure the machine is always working under the best conditions and is properly maintained to prevent problems.

5.4. Working position

MC550 can work with the machine bed horizontal or vertical as needed, according to the work to be done.

To place the bending machine in horizontal position:

1. Secure the machine at the anchor point indicated in the illustration with a forklift.
2. Lift the machine carefully until it is not in contact with the ground

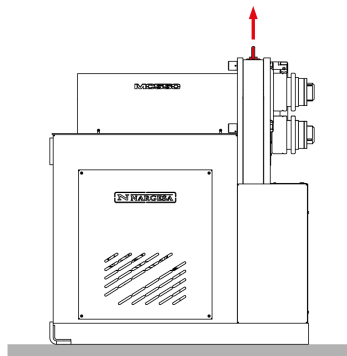

3. Lower it so that the part behind the machine bed is resting on the ground.
4. Using the forklift, carefully move the machine backwards until the machine bed is totally resting on the ground.

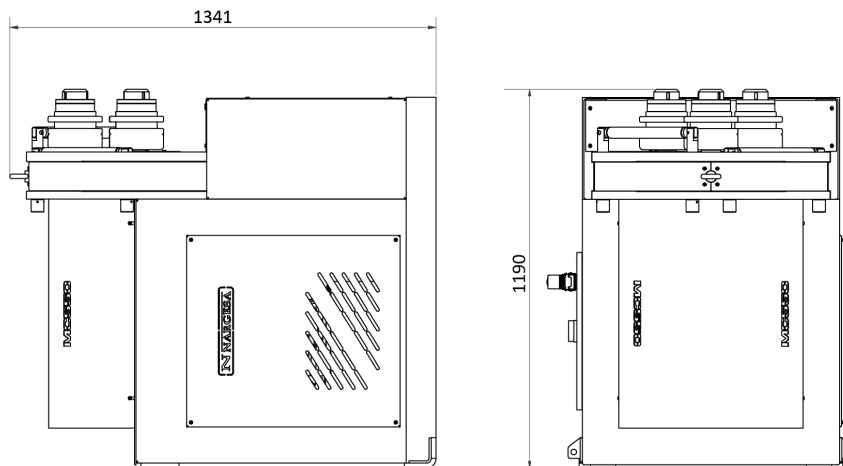
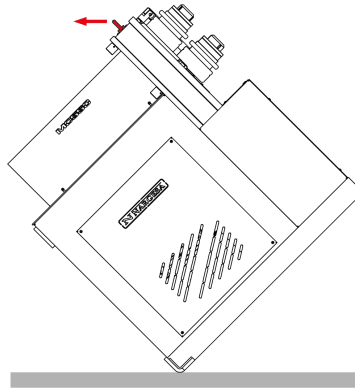

Figure 13. Machine dimensions with the base-plate in a horizontal position

WARNING:

To change the position of the machine from vertical to horizontal or vice versa, it must be switched off and with the emergency stop button pressed.

When carrying out the operation, make sure the control panel and power cables are not caught.

6. WARNINGS

The MC550 bending machine is designed and assembled to allow the operator to handle the machine and bend the necessary parts in a completely safe manner. Any change to the machine's structure or characteristics could modify the safety offered by the machine, breaching the EC certificate of conformity and could endanger the operator.

6.1. Residual hazards

Hazardous conditions may occur during the bending of materials that must be analysed and prevented.

Attention should be paid to the movements of the piece to be bent and the roller while the material is being introduced into the machine as well as during its shaping. Despite the fact that the forward speed of the rollers is slow, there is a risk of entrapment in the extremities between the rollers and the part.

Users of the machine are recommended to handle the part to be bent firmly with one hand and to move the hand according to the progress of the bending operation in order to maintain a safe distance from the rollers.

It is also necessary to prepare the work area to prevent other operators from injuring themselves during operation of the machine.

6.2. Counter-productive methods

Tools or rollers that are not supplied by the manufacturer of the machine, NARGESA S.L., and which have not been specially designed for the MC550 bending machine should never be used .

6.3. Other recommendations

- Use gloves for handling the machine and during the bending processes.
- Wear EC-approved goggles and protective boots
- Handle the material at the ends, and never around the area being bent
- Do not work without the protection devices that the machine is fitted with
- Ensure that there is a safe distance between the machine and the operator

7. ASSEMBLING OF THE ROLLERS

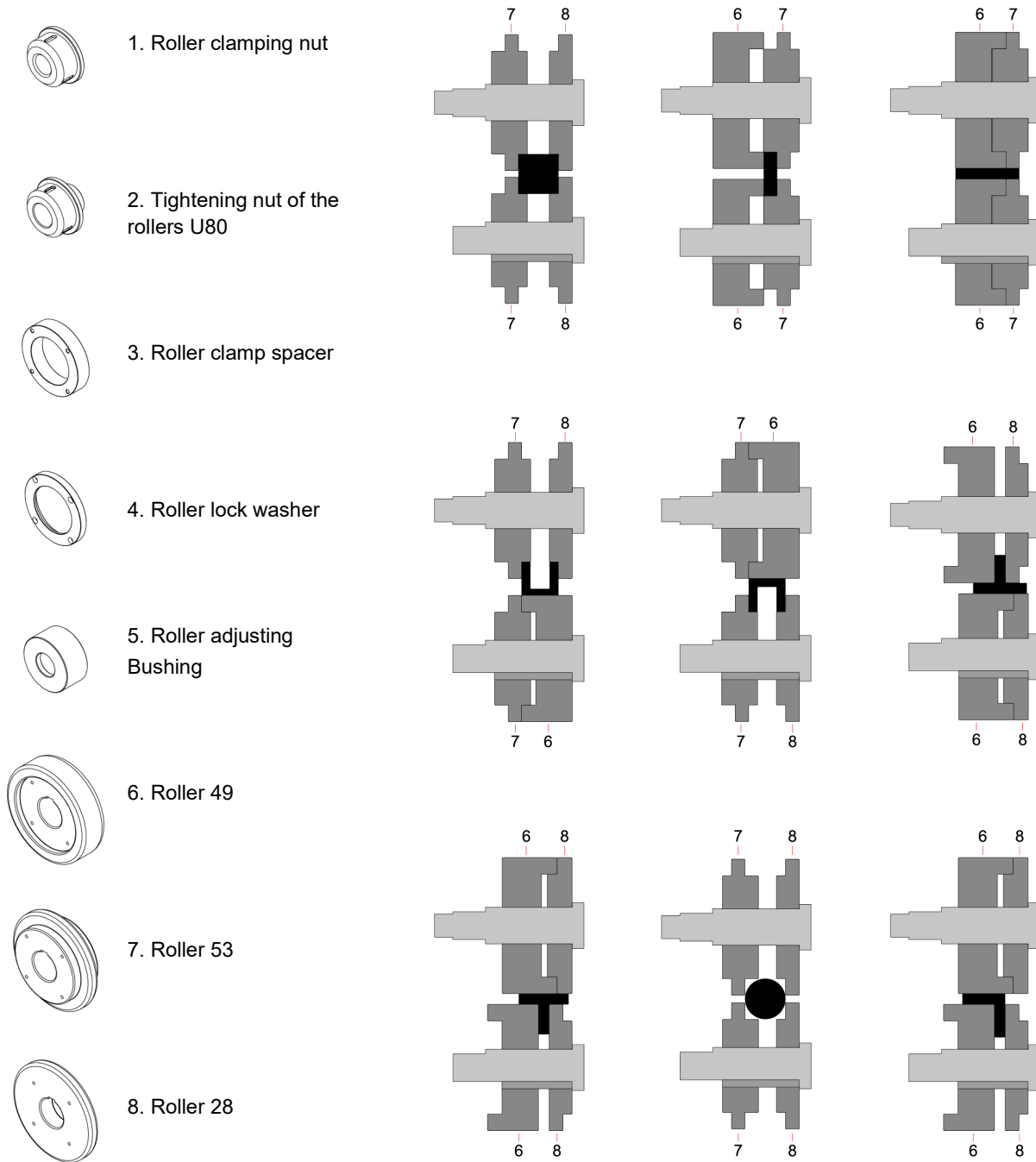

Figure 14. Nomenclature of the rollers and assembly

IMPORTANT NOTE:

The clamping nut of the rollers should never be tightened with a wrench and only by hand. If pipe rollers are being used, the nuts must be loose.

7.1. Bending capacity













Profile	MC150B		MC200		MC400		MC200H	
	Measures	Min. radius	Measures	Min. radius	Measures	Min. radius	Measures	Min. radius
	50 x 8	300	50 x 10	300	50 x 10	250	60 x 10	200
	60 x 20	200	80 x 20	150	80 x 20	150	80 x 20	150
	25 x 25	200	30 x 30	200	30 x 30	150	30 x 30	150
	40 x 40 x 3	350	50 x 50 x 3	700	50 x 50 x 3	600	50 x 50 x 3	450
	40	200	40	200	40	150	40	200
	40	250	40	250	40	200	40	250
	50	200	60	300	60	225	60	225
	50	250	60	300	60	225	60	225
	40	500	40	420	40	200	40	300
	25	180	30	150	30	150	30	150
	40 x 2 *	300	40 x 2 *	250	40 x 2 *	200	40 x 2 *	200
	50,8 x 3 *	600	63,5 x 3 *	500	63,5 x 3 *	450	76,2 x 2 *	500
	= 2" x 3 *	600	= 2"1/2 x 3 *	500	= 2"1/2 x 3 *	450	= 3" x 2 *	500

* Optional rollers

SECTION BENDING MACHINE MC550



Profile	MC550 · MC550NC · MC550CNC		MC650 · MC650NC · MC650CNC		
	Measures	Min. radius	Measures	Min. radius	
	60x15	400	100x15	1250	
	60x8	200		80x20	450
	50x15	350		60x15	300
	50x10	175		50x15	155
	40x8	150		20x10	140
	30x5	110			
	25x5	105			
	100x20	250	120x20	250	
	80x20	200	100x25	350	
	80x15	180	80x20	200	
	40x40	400	400	300	
	30x30	180	180	280	
	25x25	175	175	200	
	20x20	150	150	150	
	15x15	150	150		
	60x60x3	800	70x70x4	750	
	50x50x3	600	60x60x3	750	
	35x35x3	200	40x40x3	300	
	70x30x3	500	80x40x3	500	
	60x30x3	400	60x30x3	300	
	50x30x3	250	50x30x3	250	
	60x60x7	300	80*	500	
	50x50x6	250	70	400	
	40x40x5	200	60	200	
	60x60x7	500	40	150	
	50x50x6	400	80*	500	
	40x40x5	300	60	400	
	60x60x7	350	40	150	
	50x50x6	300	60x8	450	
	40x40x5	250	40x6	250	
	40x20x5	160	120*	600	
	60x30x6	200	100*	600	
	80x45x6	400	80	350	
	80x45x6	500	120*	700	
	60x30x6	250	100*	700	
	40x20x5	200	80	400	
	50x5	550	70x7	600	
	40x5	400	60x5	400	
			50x5	300	
			40x4	250	



	MC550 · MC550NC · MC550CNC		MC650 · MC650NC · MC650CNC	
Profile	Measures	Min. radius	Measures	Min. radius
	50x5 40x4	750* 500*	50x5 40x4	750* 500*
	40 35 30 20	300 250 200 130	50 40 25	300 200 175
			101,6x3,5* (=4"x3) 100x3* 88,9x4* (=3"SCH) 35x2* 20x1,5*	500 500 700 120 115

8. OPTIONAL ACCESSORIES

Set of treated steel rollers



Set of 3 sets of treated steel rollers for steel round pipe or stainless steel, thickness bigger than 2 mm.

When pipe sizes are smaller, two sizes are included in the same roller. Eg. (25 + 30)
Always clean up the rollers well before using stainless steel not to get the pipe contaminated.

Tube size in mm		
Reference	Dimensions	Weight
140-08-13-RHT0001	(25 + 30)	40,04 Kg
140-08-13-RHT0002	(20 + 35)	39,65 Kg
140-08-13-RHT0003	40	39,93 Kg
140-08-13-RHT0004	50	36,24 Kg
140-08-13-RHT0005	60	31,92 Kg
140-08-13-RHT0006	70	28,57 Kg
140-08-13-RHT0007	80	23,22 Kg
For Schedule pipe		
140-08-13-RHISOT0001	$(3/8" + 1/2") = (17,2 + 21,3 \text{ mm})$	43,53 Kg
140-08-13-RHISOT0002	$(1" + 3/4") = (33,7 + 26,9 \text{ mm})$	38,57 Kg
140-08-13-RHISOT0003	1" 1/4 = 42,4 mm	39,11 Kg
140-08-13-RHISOT0004	1" 1/2 = 48,3 mm	36,91 Kg
140-08-13-RHISOT0005	2" = 60,3 mm	31,77 Kg
140-08-13-RHISOT0006	2" 1/2 = 73 mm	27,01 Kg
For inches pipe		
140-08-13-RHWT0001	$(1/2" + 1"1/4") = (12,7 + 31,75 \text{ mm})$	41,67 Kg
140-08-13-RHWT0002	$(1" + 3/4") = (25,4 + 19,05 \text{ mm})$	42,35 Kg
140-08-13-RHWT0003	1"1/2 = 38,1 mm	40,56 Kg
140-08-13-RHWT0004	2" = 50,8 mm	35,92 Kg
140-08-13-RHWT0005	2"1/2 = 63,5 mm	30,28 Kg
140-08-13-RHWT0006	3" = 76,2 mm	25,31 Kg

Set of Sustarin rollers



Set of 3 Sustarin rollers for stainless steel pipes, aluminium and delicate materials for thickness smaller than 2.5 mm.
 When pipe sizes are smaller, two sizes are included in the same roller. Eg. (25 + 30)
Sustarin rollers do not spoil or contaminate the pipe.
For any other size or profile please ask the manufacturer.

Tube size in mm		
Reference	Dimensions	Weight
140-08-13-RI0001	(25 + 30)	7,24 Kg
140-08-13-RI0002	(20 + 35)	7,17 Kg
140-08-13-RI0003	40	7,22 Kg
140-08-13-RI0004	50	6,55 Kg
140-08-13-RI0005	60	5,77 Kg
140-08-13-RI0006	70	5,17 Kg
140-08-13-RI0007	80	4,20 Kg
For Schedule pipe		
140-08-13-RIISO0001	(3/8" + 1/2") = (17,2 + 21,3 mm)	7,87 Kg
140-08-13-RIISO0002	(1" + 3/4") = (33,7 + 26,9 mm)	6,98 Kg
140-08-13-RIISO0003	1" 1/4 = 42,4 mm	7,07 Kg
140-08-13-RIISO0004	1" 1/2 = 48,3 mm	6,68 Kg
140-08-13-RIISO0005	2" = 60,3 mm	5,75 Kg
140-08-13-RIISO0006	2" 1/2 = 73 mm	4,89 Kg
For inches pipe		
140-08-13-RIWT0001	(1/2" + 1"1/4") = (12,7 + 31,75 mm)	7,54 Kg
140-08-13-RIWT0002	(1" + 3/4") = (25,4 + 19,05 mm)	7,66 Kg
140-08-13-RIWT0003	1"1/2 = 38,1 mm	7,33 Kg
140-08-13-RIWT0004	2" = 50,8 mm	6,50 Kg
140-08-13-RIWT0005	2"1/2 = 63,5 mm	5,47 Kg
140-08-13-RIWT0006	3" = 76,2 mm	4,58 Kg

Technical annex

MC550 Bending Machine

General parts diagram

Hydraulic cylinder

Hydraulic group

Control panel

Electric boxes

Arrangement of axes

Control unit

Hydraulic group







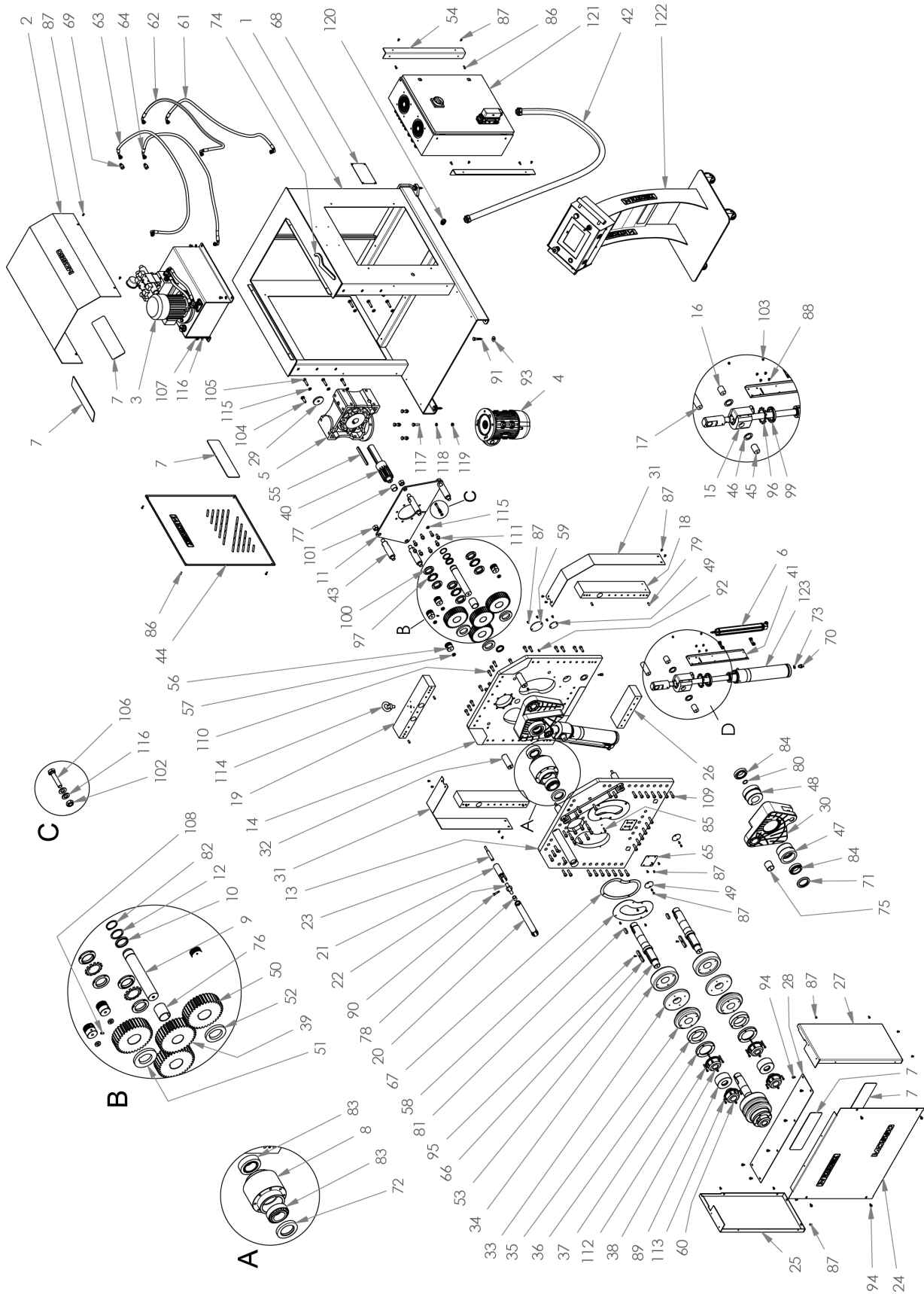

Electric maps

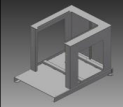
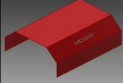

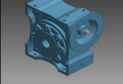
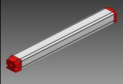

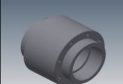
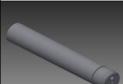

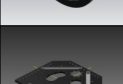
Hydraulic map

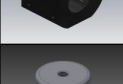
A1. General parts diagram



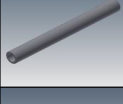
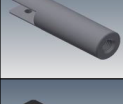
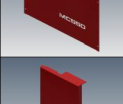
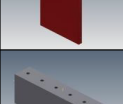

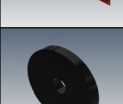







SECTION BENDING MACHINE MC550

Elemento	Miniatura	Nº de pieza	Descripción	CTDAD
1		130-08-13-00006	Chasis Curvadora MC550	1
2		130-08-13-00009	Conjunto Tapa Superior Trasera	1
3		130-08-08-00022	GRUPO HIDRAULICO MC650 I MC550	1
4		050-ME-00025	Motor 90L 4 B5 kW1.5 230/400 IE2	1
5		050-RT-00009	Reductor BOX110 i:80 Dout42 Dm24 P90B5	1
6		050-PO-00009	Potenciómetro RTL 250 D 5k C1	2
7		120-08-12-00081	Metacrilato Negro Tapa Frontal Logo Nargesa	5
8		120-08-13-00009	Buje del Eje Superior	1
9		120-08-13-00021	Eje Central Pivote Bielas	1
10		120-08-13-00027	Arandela De Bronce Eje Central	2
11		120-08-13-00028	Soporte del Reductor	1
12		120-08-13-00029	Arandela Trasera Eje Central D49XD40.2X2	1
13		120-08-13-00043	Oxicorte Frontal	1
14		120-08-13-00044	Oxicorte Trasero	1
15		120-08-13-00045	Soporte Pivotante del Pistón	2
16		120-08-13-00046	Pasdor Cromado D30 Trasero Pivote del Pistón	2

Elemento	Miniatura	Nº de pieza	Descripción	CTDAD
17		120-08-13-00059	Pasador Cromado Bielas-Pistón	2
18		120-08-13-00060	Pasamano Lateral de Separación de Oxicortes	2
19		120-08-13-00062	Pasamano Superior de Separación de Oxicortes	1
20		120-08-13-00065	Barra Rodillo del Empujador	2
21		120-08-13-00069	Horquilla Empujador	4
22		120-08-13-00070	Cabeza del Empujador	4
23		120-08-13-00072	Varilla Roscada Empujadores	4
24		120-08-13-00073	Tapa Frontal	1
25		120-08-13-00074	Tapa Lateral Izquierda	1
26		120-08-13-00075	Pasamano Inferior de Separación de Oxicortes	1
27		120-08-13-00076	Tapa Lateral Derecha	1
28		120-08-13-00077	Tapa Superior de la Cubierta de Pistones	1
29		120-08-13-00078	Arandela Fijacion Eje Reductor	1
30		120-08-13-00090	Oxicorte de Bielas	2
31		120-08-13-00091	Tapa cubierta entre oxicortes	2
32		120-08-13-00092	Redondo de Separación de Oxicortes	2

SECTION BENDING MACHINE MC550

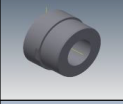
Elemento	Miniatura	Nº de pieza	Descripción	CTDAD
33		120-08-13-00093	Rodillo 3 D170/130X28 Eje de 50	3
34		120-08-13-00094	Rodillo 1 D170X49 Eje de 50	3
35		120-08-13-00095	Rodillo 2 D170/130X53 Eje de 50	3
36		120-08-13-00096	Separador de Apriete de los Rodillos	3
37		120-08-13-00097	Arandela de Apriete de los Rodillos	3
38		120-08-13-00098	Tuerca de Apriete de los Rodillos	3
39		120-08-13-00103	Engranaje de Reenvío Z35 M4	1
40		120-08-13-00105	Piñón Conductor Central Z14 M4	1
41		120-08-13-00107	Soporte del Encoder	2
42		130-08-13-00034	Tubo Protección del Cableado Pupitre - Máquina	1
43		120-08-13-00111	Redondo de Separación del Soporte del Reductor	4
44		120-08-13-00112	Tapa Lateral	1
45		120-08-13-00115	Pasador Cromado D30 Frontal Pivote del Pistón	2
46		120-08-13-00116	Arandela Anti-rozamiento	4
47		120-08-13-00117	Buje de Ejes Laterales Parte Frontal	2
48		120-08-13-00118	Buje de Ejes Laterales Parte Trasera	2

Elemento	Miniatura	Nº de pieza	Descripción	CTDAD
49		120-08-13-00119	Tapa del Bulón Pivote del Pistón	4
50		120-08-13-00120	Piñón Ejes Rulinas Z35 M4 L40	3
51		120-08-13-00121	Arandela Piñón Z35 M4 Eje Central	1
52		120-08-13-00122	Arandela Piñón Z35 M4 Ejes Laterales	2
53		120-08-13-00123	Eje de Rodillos	3
54		120-08-13-00128	Soporte Cuadro Eléctrico	2
55		120-08-13-00147	Chaveta Eje Motor	1
56		120-08-13-00148	Maneta Empujadores	4
57		120-08-13-00149	Arandela Bronce Pomos	4
58		120-08-13-00150	Tapa Ejes Oxicortes	2
59		120-08-13-00152	Tapa Extracción Bulón Pistón	2
60		120-08-13-00153	Tuerca U80	3
61		120-08-13-00159	Manguera Hidráulica 1/4" - Codo 90º TG 1/4" - Codo 90º TG 1/4" - 250 bars, L=1150 mm - Conexiones orientadas a 90º ISO 17165-1	1
62		120-08-13-00160	Manguera Hidráulica 1/4" - Codo 90º TG 1/4" - Codo 90º TG 1/4" - 250 bars, L=1300 mm - Conexiones orientadas a 270º ISO 17165-1	1
63		120-08-13-00161	Manguera Hidráulica 1/4" - Codo 90º TG 1/4" - Codo 90º TG 1/4" - 250 bars, L=1300 mm - Conexiones orientadas a 270º ISO 17165-1	1
64		120-08-13-00162	Manguera Hidráulica 1/4" - Codo 90º TG 1/4" - Codo 90º TG 1/4" - 250 bars, L=1150 mm - Conexiones orientadas a 90º ISO 17165-1	1

SECTION BENDING MACHINE MC550

Elemento	Miniatura	Nº de pieza	Descripción	CTDAD
65		120-08-13-00164	Tapa Soporte Encoder	1
66		120-08-13-00165	Chaveta Paralela 1 Lado Recto DIN 6885AB 14X9X90	3
67		120-08-13-00175	Tapa Ejes Oxicortes	2
68		122-PLC-0813-001	Placa Características MC650	1
69		040-SMH-00002	Suplemento Macho Hembra 1/4	2
70		040-RMM-00002	Racor 1/4" Macho Macho	2
71		040-RET-00018	Reten TC D60x80x10	2
72		040-RET-00017	Reten TC D60x90x13	1
73		040-JMG-00002	Junta Metal Goma 1/4' Gas	2
74		031-LLGU-00001	Llave Gancho Con Uña 80/90	1
75		030-DP-00058	DOLLA PARTIDA D40xD44x45	2
76		030-DP-00017	DOLLA PARTIDA D40xD44x50	1
77		030-DP-00012	Dolla Partida D30xD34x25	1
78		030-DP-00010	Casquillo Bronce D16xD22x20	4
79		030-DIN7979D-8X20	PASADOR CILINDRICO DIN 7979D Ø8X20	8
80		030-DIN472-30X1C2	Circlip Agujero Din472 D30X1,2	2

Elemento	Miniatura	Nº de pieza	Descripción	CTDAD
81		030-D6885A-00045	Chaveta Paralela DIN 6885A 14X9X40	3
82		030-D471-00005	Circlip de Eje DIN 471 D40	1
83		030-CJ-00040	Rodamiento de Rodillos Cónicos 33210 D50xD90x32	2
84		030-CJ-00039	Rodamiento de Rodillos Cónicos 32010 50X80X20	4
85		020-I7380-M6X25	TORNILLO ALLEN ABOMBADO ISO7380 M6X25	1
86		020-I7380-M6X16	Tornillo Allen Abombado ISO7380 M6X16	8
87		020-I7380-M6X10	Tornillo Allen Abombado ISO 7380 M6X10	48
88		020-I7380-M6X8	Tornillo Allen Abombado ISO7380 M6X8	8
89		120-08-13-00174	Arandela de Vaso MC550	3
90		020-I7379-D8X25	Tornillo Guía ISO 7379 D8X25-M6	4
91		020-DIN571-10X60	Tornillo Hexagonal Para Madera	4
92		020-D71412-00003	Engrasador Recto DIN 71412 M8	5
93		020-D9021-M10	ARANDELA DIN 9021 M10	4
94		020-D6921-M6X12	Tornillo Hexagonal Embridado M6X12	10
95		020-D6912-M5X12	Tornillo Allen de Cabeza Reducida DIN 6912 M5 x 12	3
96		020-D5406-MB12	Arandela de Fijación MB12 - DIN 5406	2

SECTION BENDING MACHINE MC550

Elemento	Miniatura	Nº de pieza	Descripción	CTDAD
97		020-D5406-MB9	Arandela de Fijación MB9	3
98		020-D985-M6	TUERCA AUTOBLOCANTE DIN 985 M6	2
99		020-D981-KM12	TUERCA RANURADA DIN 981 M60x2 KM12	2
100		020-D981-KM9	Tuerca Ranurada KM9 M45x150	6
101		020-D934-M20	Tuerca DIN 934 M20	4
102		020-D934-M8	TUERCA HEXAGONALI DIN934 M8	1
103		020-D934-M6	Tuerca Hexagonal DIN934 M6	2
104		020-D933-M12X35	Tornillo Hexagonal DIN 933 M12x35	1
105		020-D933-M10X45	Tornillo Hexagonal DIN933 M10X45	6
106		020-D933-M8X40	TORNILLO HEXAGONAL DIN 933 M8X40	1
107		020-D933-M8X12	TORNILLO HEXAGONAL DIN 933 M8X12	4
108		020-D913-M6X12	ESPARRAGO ALLEN DIN 913 M6X12	8
109		020-D912-M10X35	TORNILLO ALLEN DIN912 M10X35	41
110		020-D912-M10X30	Tornillo Allen DIN 912 M10X30	35
111		020-D912-M10X25	Tornillo Allen DIN912 M10X25	8
112		020-D912-M6X50	TORNILLO ALLEN DIN912 M6X50	12

Elemento	Miniatura	Nº de pieza	Descripción	CTDAD
113		020-D912-M6X25	Tornillo Allen DIN912 M6X25	12
114		020-D580-M16X2-ZN	Cancamo Macho Din580 M16X2 - Zn	1
115		020-D125B-M10	Arandela Biselada DIN125B Para M10	14
116		020-D125B-M8	Arandela Biselada DIN125B Para M8	6
117		020-D933-M10X40	Tornillo Hexagonal DIN933 M10X40	4
118		020-D127-M10	ARANDELA GLOWER DIN127 PARA M10	4
119		020-D934-M10	Tuerca Hexagonal DIN934 M10	4
120		050-PE-00011	Prensaestopa M20X1.5	1
121		050-KIE-0812-003	Cuadro Eléctrico MC650CNC	1
122		130-08-08-00149	PUPITRE MC650	1
123		130-08-13-00012	Pistón Curvadora Eje de 50	2

A2. Hydraulic cylinder

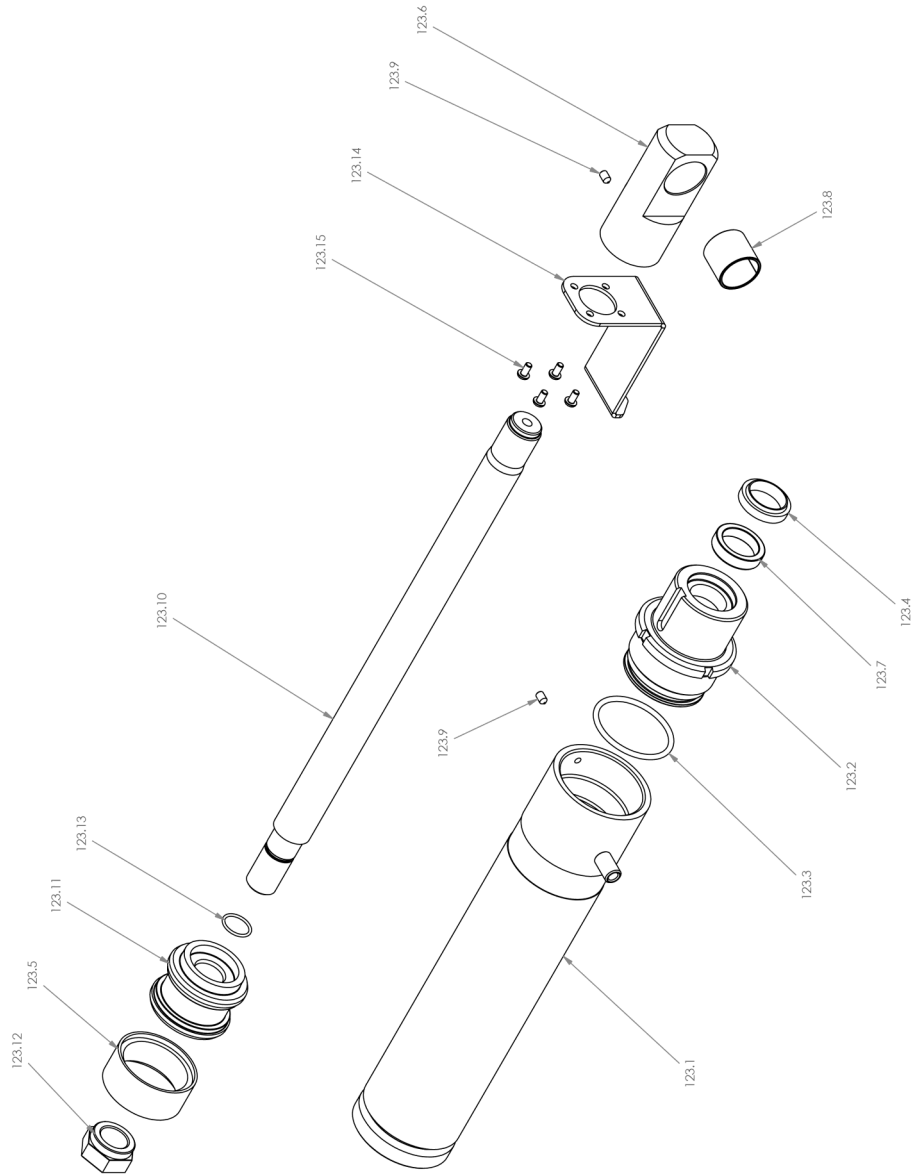

Elemento	Miniatura	Nº de pieza	Descripción	CTDAD
123.1		130-08-13-00011	Conjunto Camisa del Pistón	1
123.2		120-08-13-00050	Tuerca Cierre Vástago	1
123.3		040-JT-00036	JUNTA TORICA D58X4 90 Shore	1
123.4		040-RAS-00012	Rascador AS - D30XD40X7/10	1
123.5		040-DPS-00008	Junta DPS D65XD53 SIMKO 320X2	1
123.6		120-08-13-00057	Cabeza del Vástago del Pistón	1
123.7		040-BA-00019	Collarín T20 30x40x10	1
123.8		030-DP-00013	DOLLA PARTIDA D30XD34X30	1
123.9		020-D914-M6X10	Esparrago Allen Con Punta DIN 914 M6x10	2
123.10		120-08-13-00131	Cromado Vástago del Pistón	1
123.11		120-08-13-00130	Émbolo Pistón	1
123.12		120-08-13-00132	Tuerca Trasera Cilindro Hex. 36mm - M24x1.5	1
123.13		040-JT-00037	JUNTA TORICA D20X2 NBR 90 Sh	1
123.14		120-08-13-00109	Chapa de Amarre del Encoder al Vástago	2
123.15		020-I7380-M5x10	TORNILLO ISO 7380 M5X10	8

A3. Hydraulic group

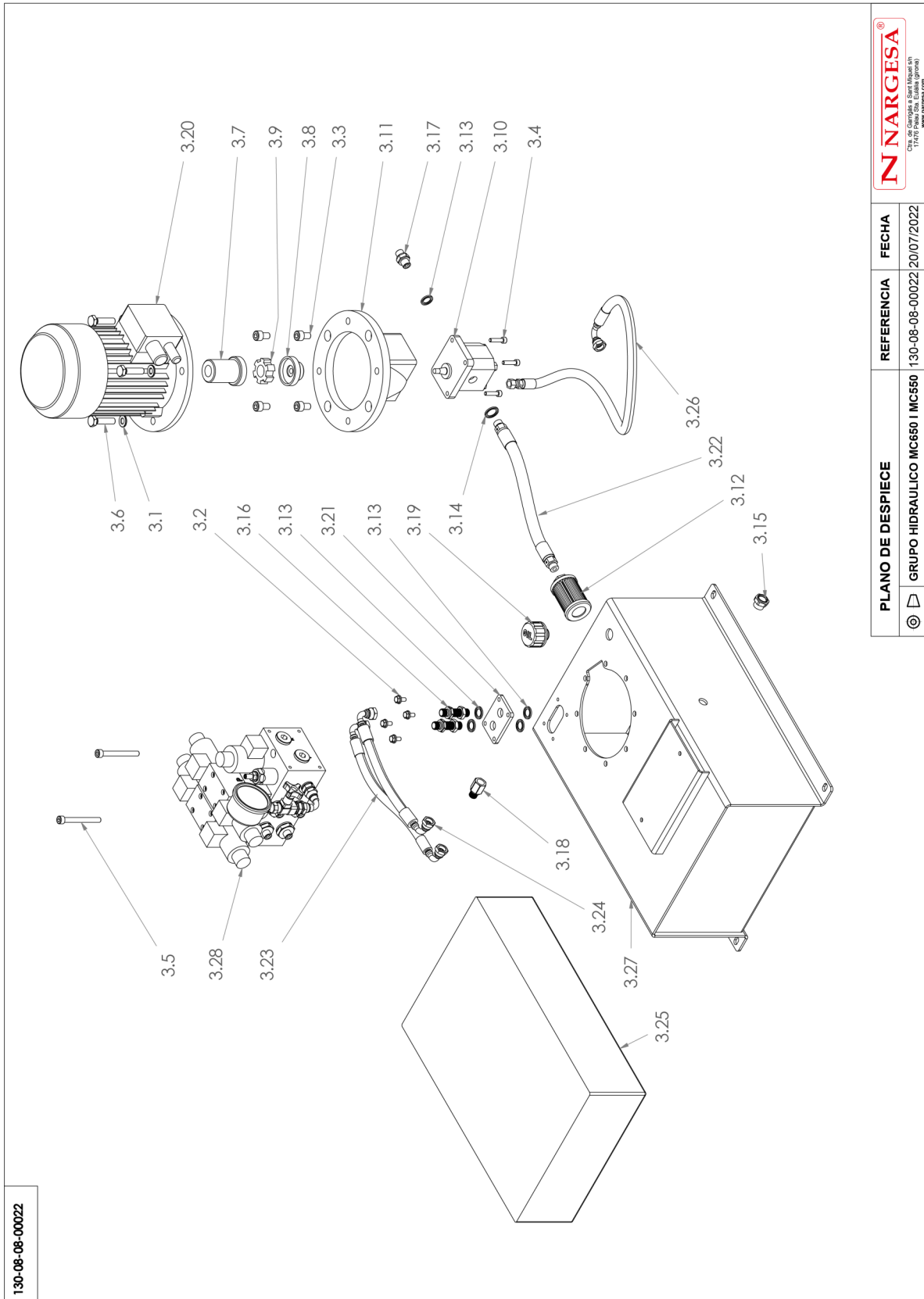

130-08-08-00022











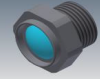
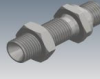

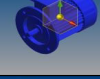

PLANO DE DESPIECE	REFERENCIA	FECHA
	GRUPO HIDRAULICO MC650 I MC550	20/07/2022

Este plano es propiedad de Prácticas Nargesa S.L. No podrá ser reproducido, comunicado a terceros o utilizado para otro fin que no sea el acordado en su permiso escrito.

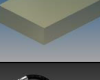
Elemento	Miniatura	Nº de pieza	Descripción	CTDAD
3.1		020-D125B-M10	Arandela Biselada DIN125B Para M10	4
3.2		020-D6921-M6X12	Tornillo Hexagonal Embridado M6X12	4
3.3		020-D912-M10X16	Tornillo Allen DIN912 M10X16	4
3.4		020-D912-M6X25	Tornillo Allen DIN912 M6X25	4
3.5		020-D912-M8X75	Tornillo Allen DIN912 M8X75	2
3.6		020-D933-M10X40	Tornillo Hexagonal DIN933 M10X40	4
3.7		040-AE-00011	ACOPLAMIENTO LADO MOTOR 0.75 Kw BOMBA LO	1
3.8		040-AE-00012	ACOPLAMIENTO LADO BOMBA LO	1
3.9		040-AE-00013	ESTRELLA ACOPLAMIENTO 0.75KW BOMBA LO	1
3.10		040-BH-00004	BOMBA HIDRAULICA DE ALUMINIO DE 1.5 L	1
3.11		040-CA-00003	CAMPANA ACOPLAMIENTO BOMBA LO MOTOR 0.75/1 CV (SIN ROSCA)	1
3.12		040-FL-00005	Filtro De Aspiracion 3/8' Largo de 90	1
3.13		040-JMG-00002	Junta Metal Goma 1/4' Gas	6
3.14		040-JMG-00004	Junta Metal Goma 3/8' Gas	1

SECTION BENDING MACHINE MC550

Elemento	Miniatura	Nº de pieza	Descripción	CTDAD
3.15		040-NA-00001	Visor Nivel Aceite De 3/8' Gas	1
3.16		040-PST-00003	Pasatabique 1/4'	2
3.17		040-RMM-00002	Racor 1/4" Macho Macho	1
3.18		040-SMH-00002	Suplemento Macho Hembra 1/4	1
3.19		040-TLL-00003	Tapon Llenado De 1/2' Doble Respiradero Y Filtro	1
3.20		050-ME-00007	MOTOR ELECTRICO .75KW A 1400 rpm BRIDA B5	1
3.21		120-08-08-00106	PLACA PORTA PASATABIQUES MC650	1
3.22		120-08-08-00148	Manguera Flexible 3/8 Macho 3/8-Macho 3/8 L=230 mm P=250 Bars	1
3.23		120-08-08-00149	Manguera 1/4"-Codo 90º TG 1/4" BSP cono 60° - Codo 90º TG 1/4" cono 60° - 250 bar, L=350 mm - Conexiones a 270° ISO 17165-1	1
3.24		120-08-08-00150	Manguera 1/4"-Codo 90º TG 1/4" BSP cono 60° - Codo 90º TG 1/4" cono 60° - 250 bar, L=305 mm - Conexiones a 270° ISO 17165-1	1
3.25		120-08-08-00152	Aceite Hidraulico HV-46 MC650 16 Litros	1
3.26		120-08-08-00257	MANGUERA FLEXIBLE 1/4 CODO 90º TG 1/4 - TG 1/4 L=720 mm P=250 Bars	1
3.27		130-08-08-00023	DEPOSITO HIDRAULICO MC650	1
3.28		130-08-08-00063	Bloque de Electroválvulas MC650 I MC550	1

A4. Control panel

-CONTROL1

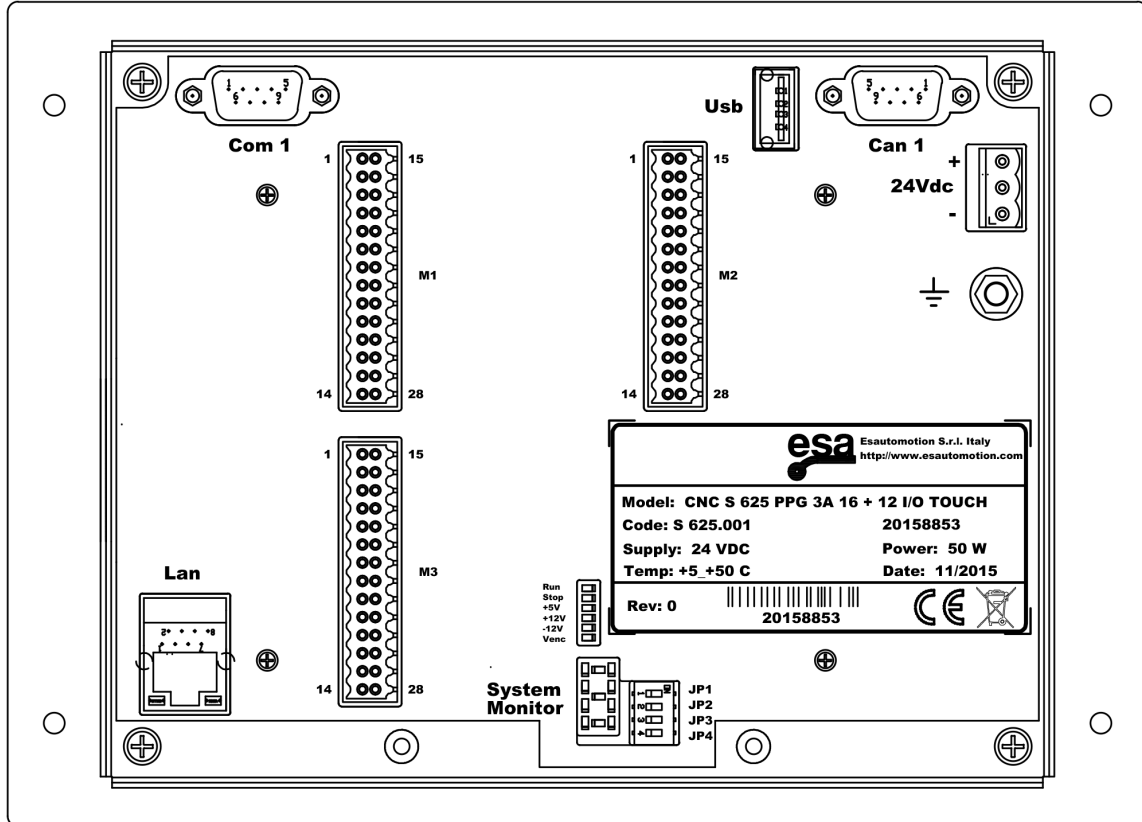

A5. Electric boxes

PLACE THE LABELS ON THE TOP OF THE TERMINALS AND FUSES.
PLACE THE TERMINALS AND FUSES WITH THE OPEN SIDE TO THE LEFT.

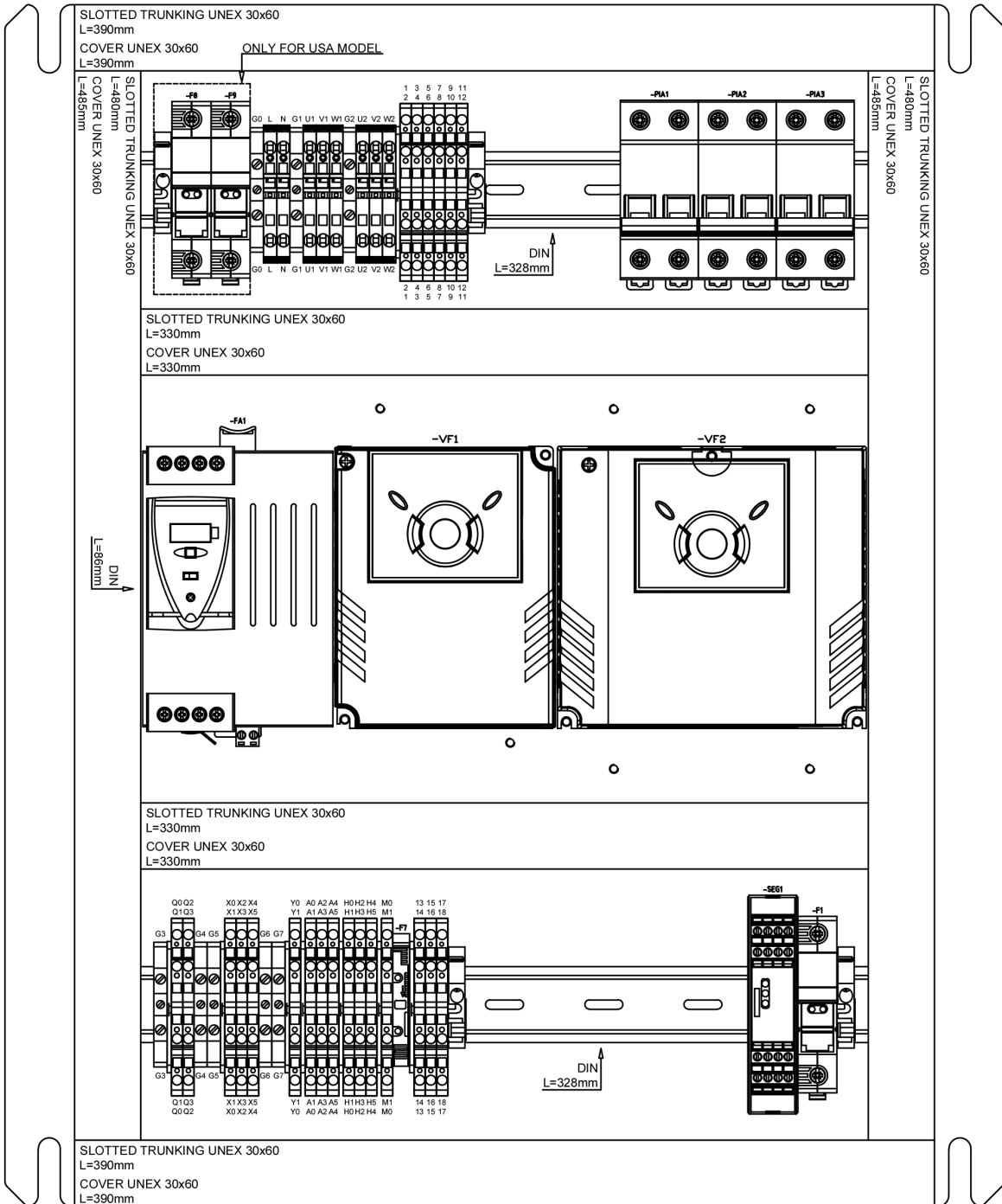

PLACE THE LABELS ON THE TOP OF THE TERMINALS AND FUSES.
PLACE THE TERMINALS AND FUSES WITH THE OPEN SIDE TO THE LEFT.

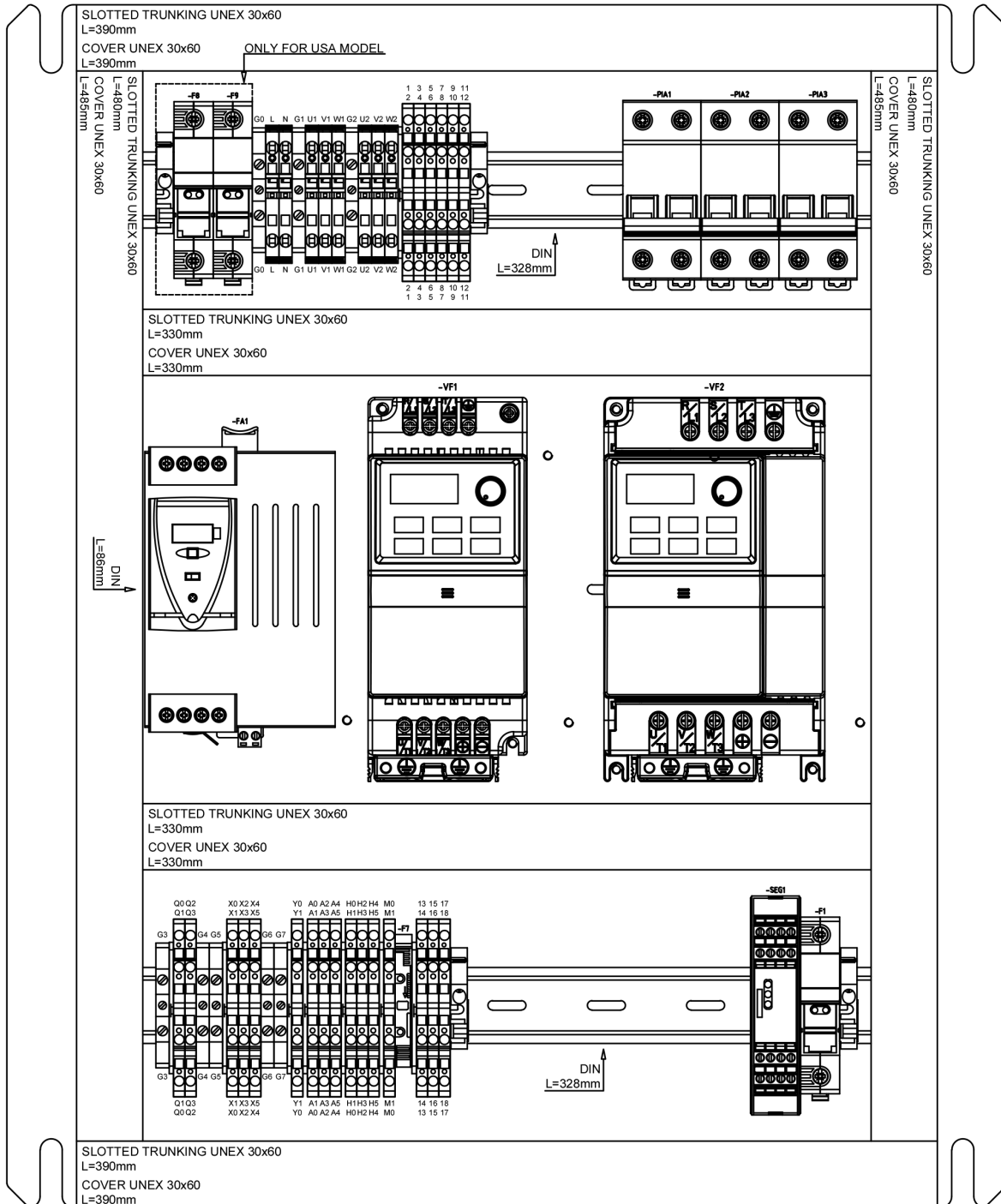

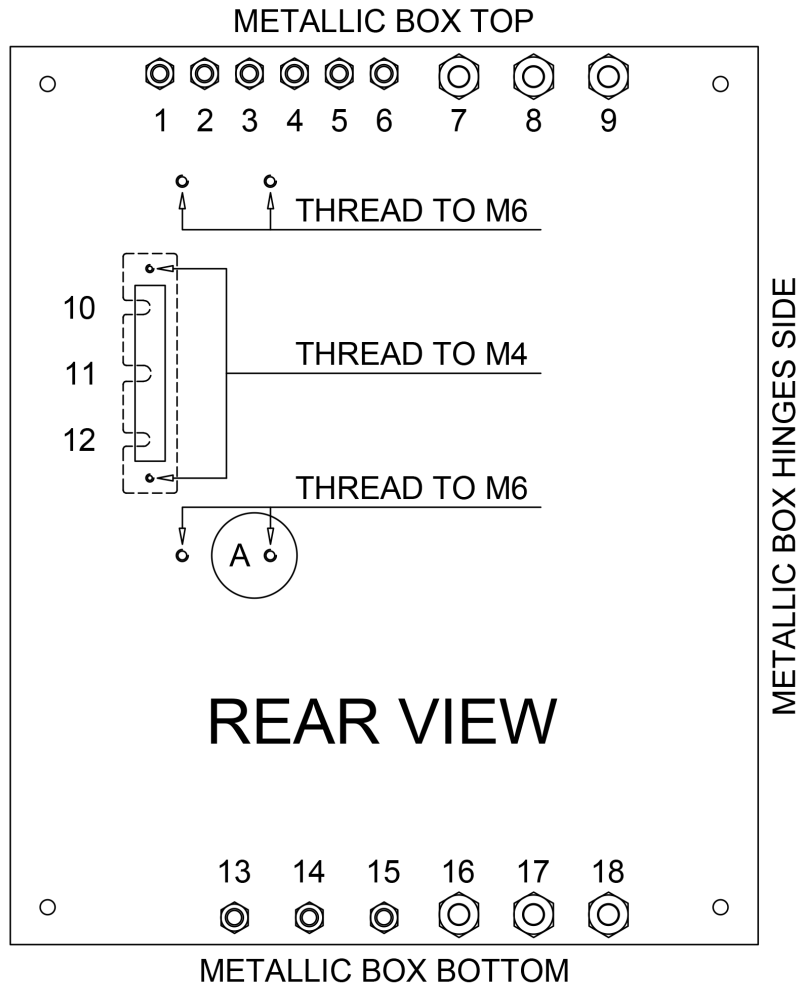

NUMBER	PLASTIC CABLE GLAND	ELECTRIC WIRE	DESCRIPTION
1	PG9	-MG4	EVP (PRESSURE ELECTROVALVE)
2	PG9	-MG5	EVUX (X AXIS UP ELECTROVALVE)
3	PG9	-MG6	EVDX (X AXIS DOWN ELECTROVALVE)
4	PG9	-MG7	EVUY (Y AXIS UP ELECTROVALVE)
5	PG9	-MG8	EVDY (Y AXIS DOWN ELECTROVALVE)
6	PG9	---	---
7	M20	-MG3	ROLLER MOTOR
8	M20	-MG2	PUMP MOTOR
9	M20	-MG1	POWER INPUT
10	---	---	---
11	---	---	---
12	---	---	---
13	PG9	---	---
14	PG9	---	---
15	PG9	-MG15	PH1 (MATERIAL PHOTOCELL)
16	M20	-MG20	ENC1 (R AXIS ROTARY ENCODER)
17	M20	-MG12	PX (X AXIS 5K LINEAR POTENTIOMETER)
18	M20	-MG13	PY (Y AXIS 5K LINEAR POTENTIOMETER)

A6. Arrangement of axes

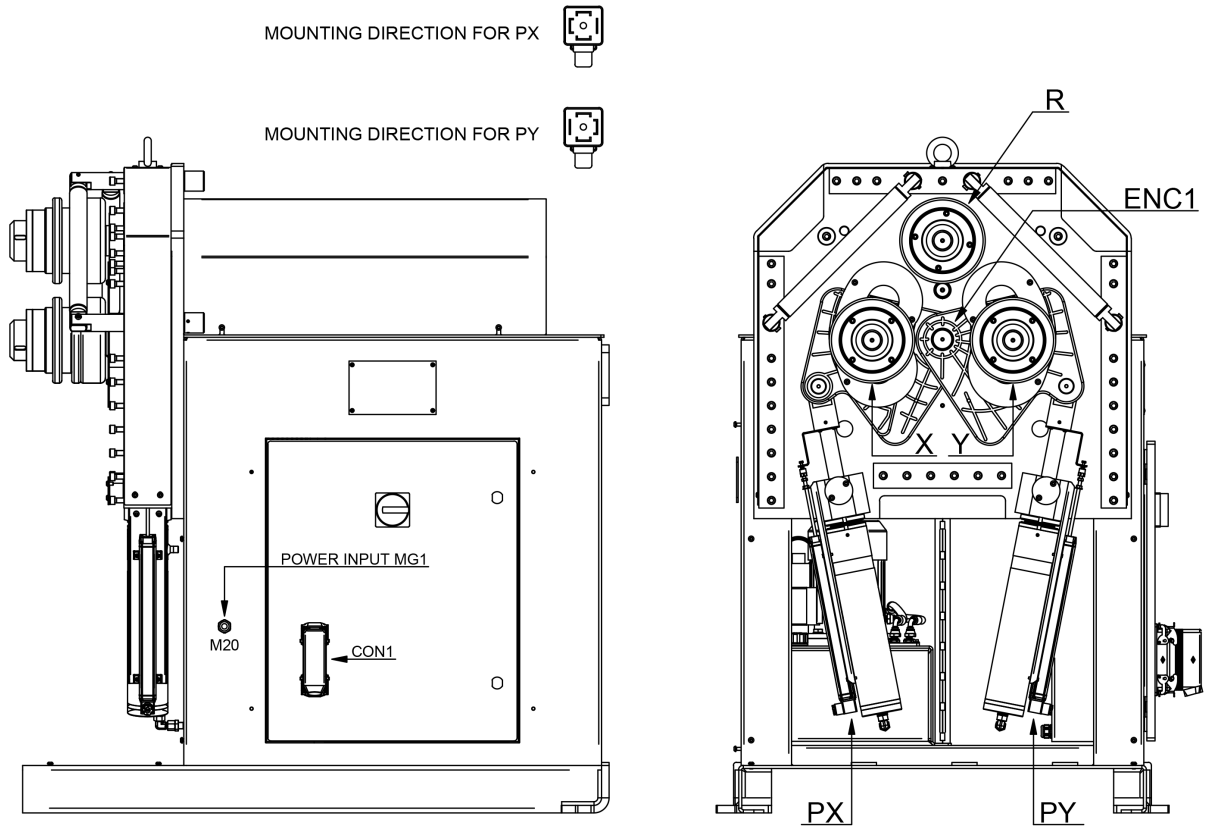

A7. Control unit

PLACE THE LABELS ON THE TOP OF THE TERMINALS AND FUSES.
PLACE THE TERMINALS AND FUSES WITH THE OPEN SIDE TO THE LEFT.

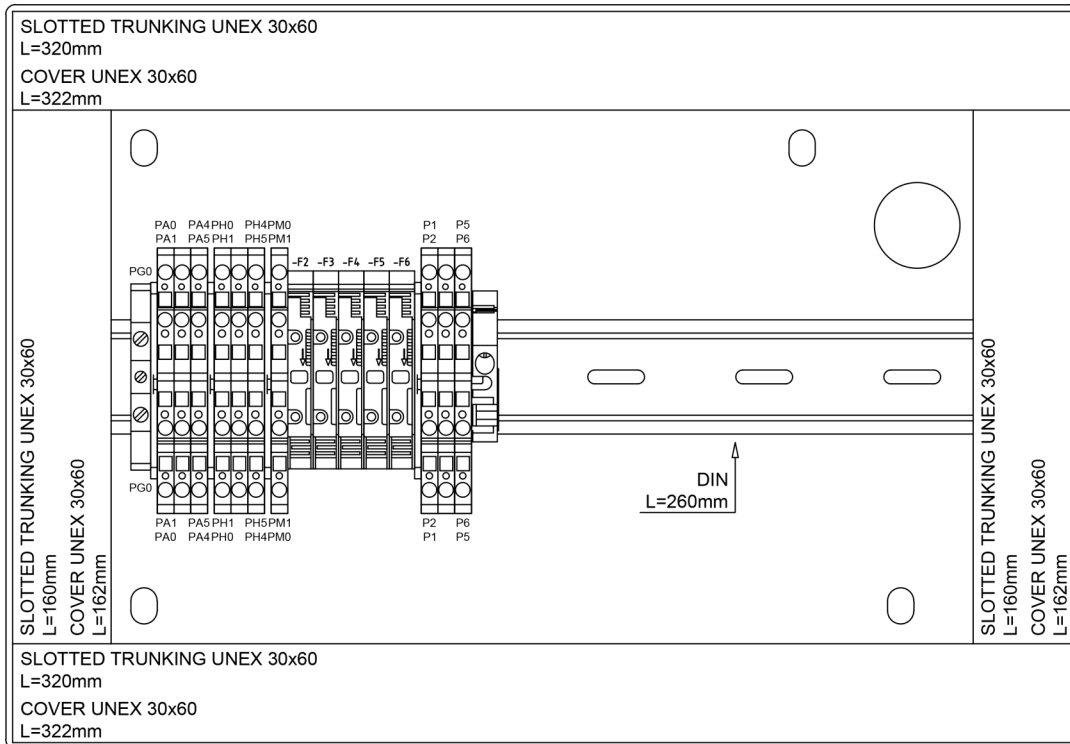

USER CONTROL INNER VIEW

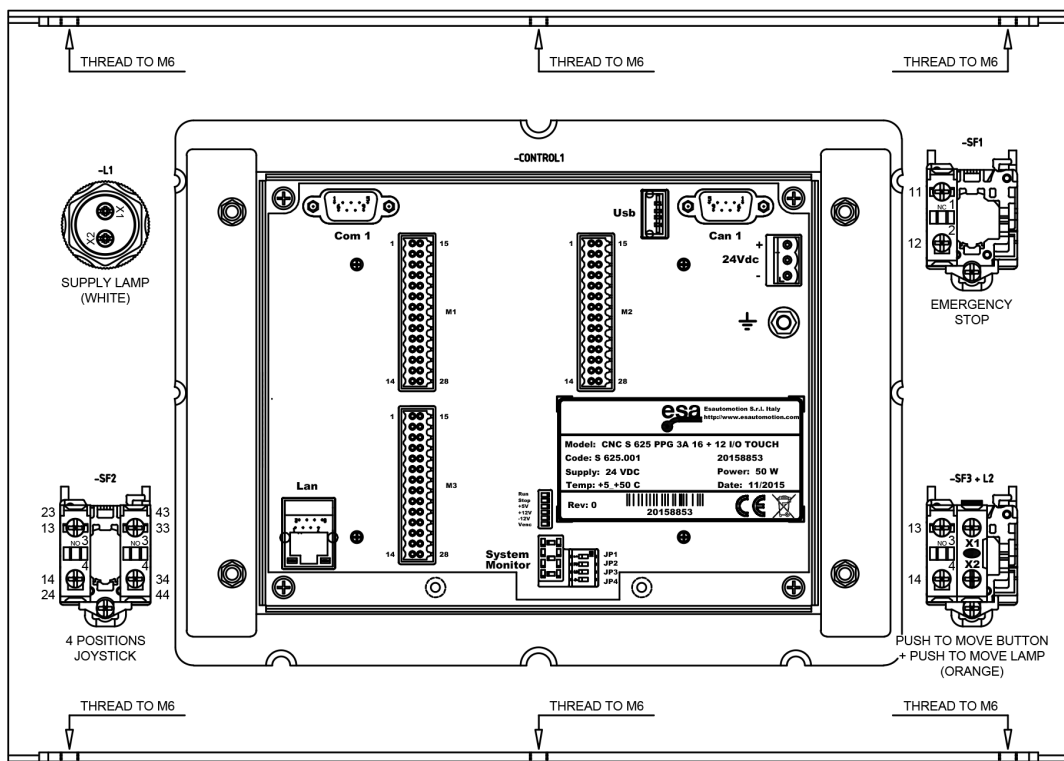

A8. Hydraulic group

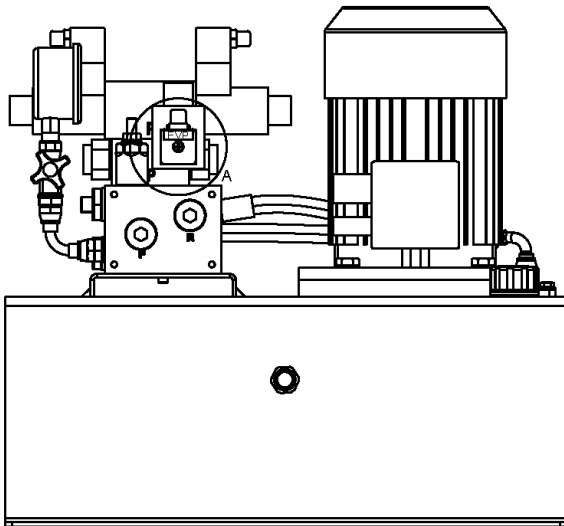

MOUNTING DIRECTION FOR ALL VALVES 

NOTE: ADJUST THE PRESSURE LIMITER TO 150 BAR

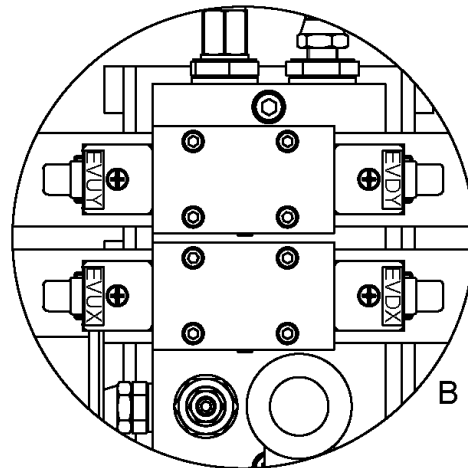
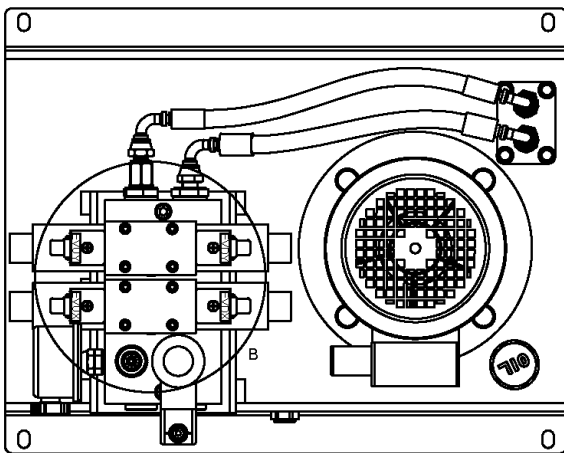
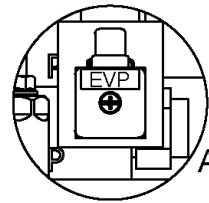

A9. Electric maps

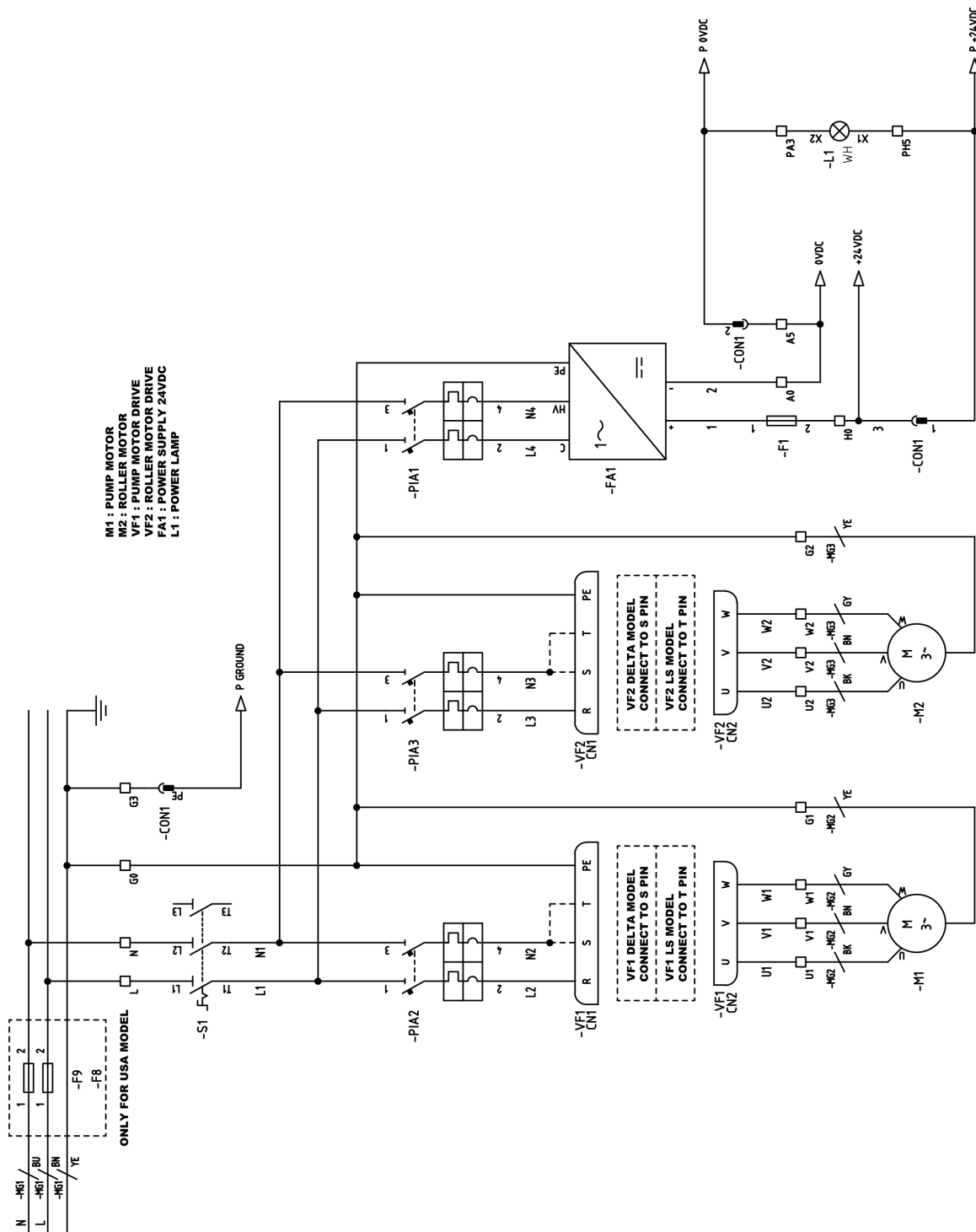

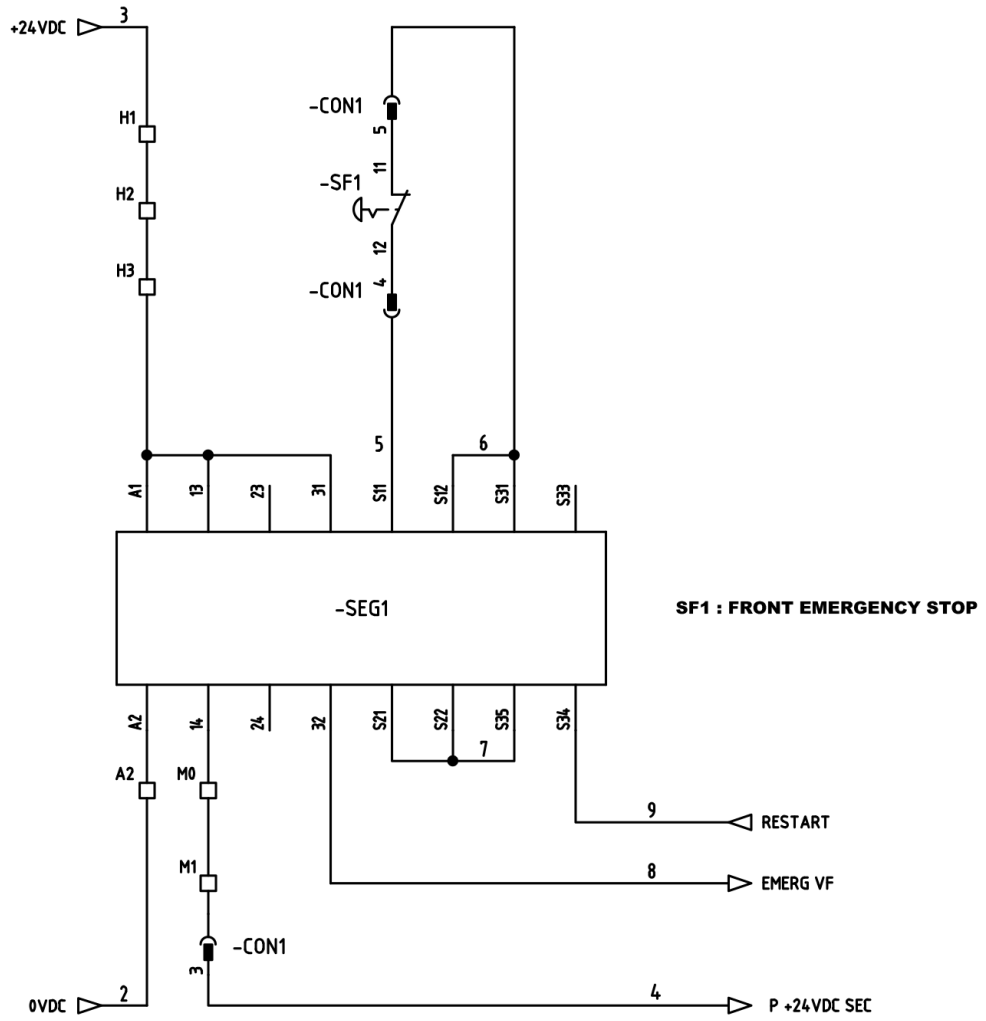

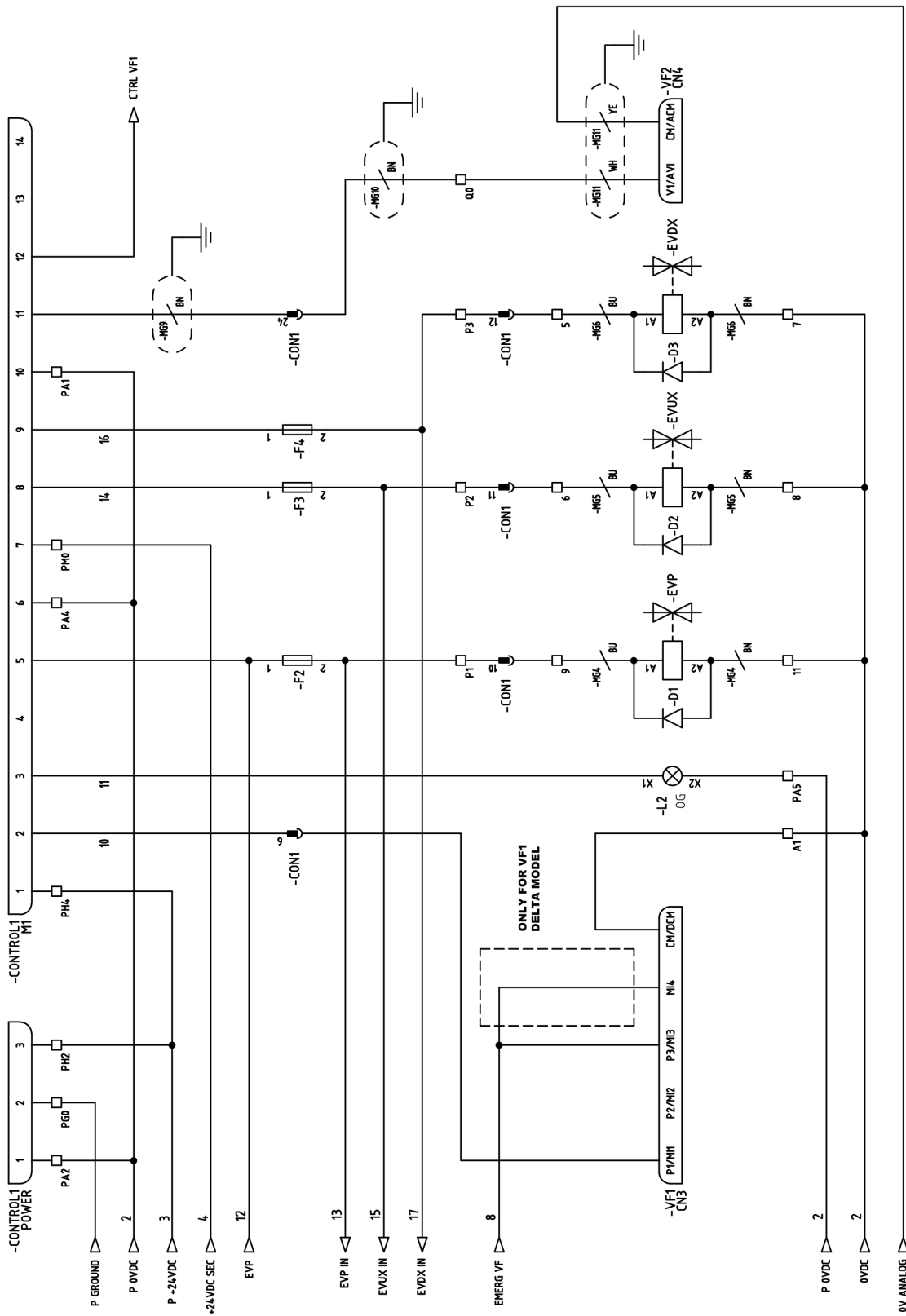

CONTROL 1 : S625 ESA NUMERIC CONTROL
 L2 : PUSH TO MOVE LAMP
 VF1 : PUMP MOTOR DRIVE
 VF2 : ROLLER MOTOR DRIVE
 EVP : PRESSURE ELECTROVALVE
 EVUX : X AXIS UP ELECTROVALVE
 EVDX : X AXIS DOWN ELECTROVALVE

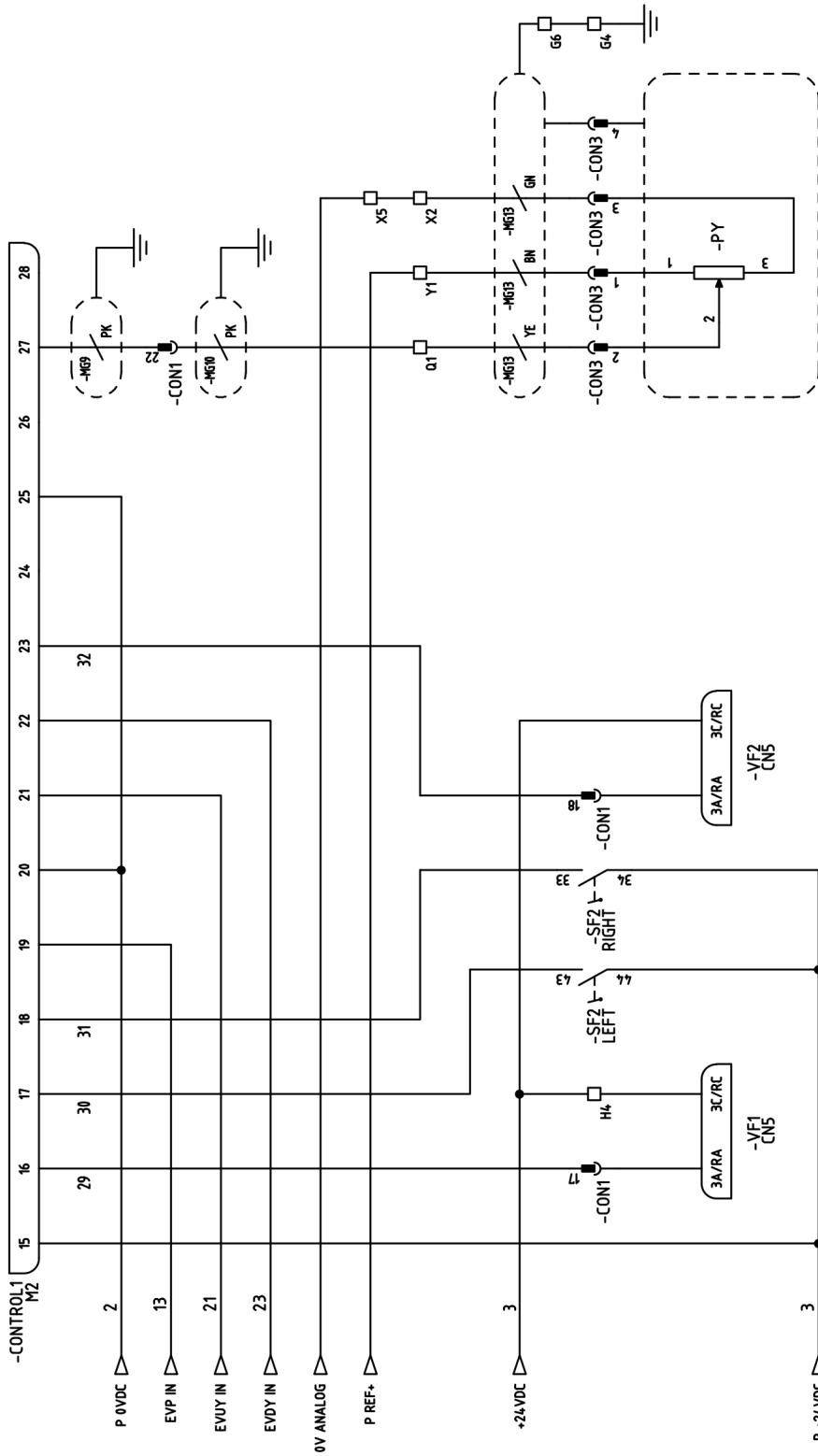

CONTROL1 : S625 ESA NUMERIC CONTROL
 VF1 : PUMP MOTOR DRIVE
 VF2 : ROLLER MOTOR DRIVE
 SF2 : JOYSTICK
 PY : Y AXIS 5K LINEAR POTENTIOMETER

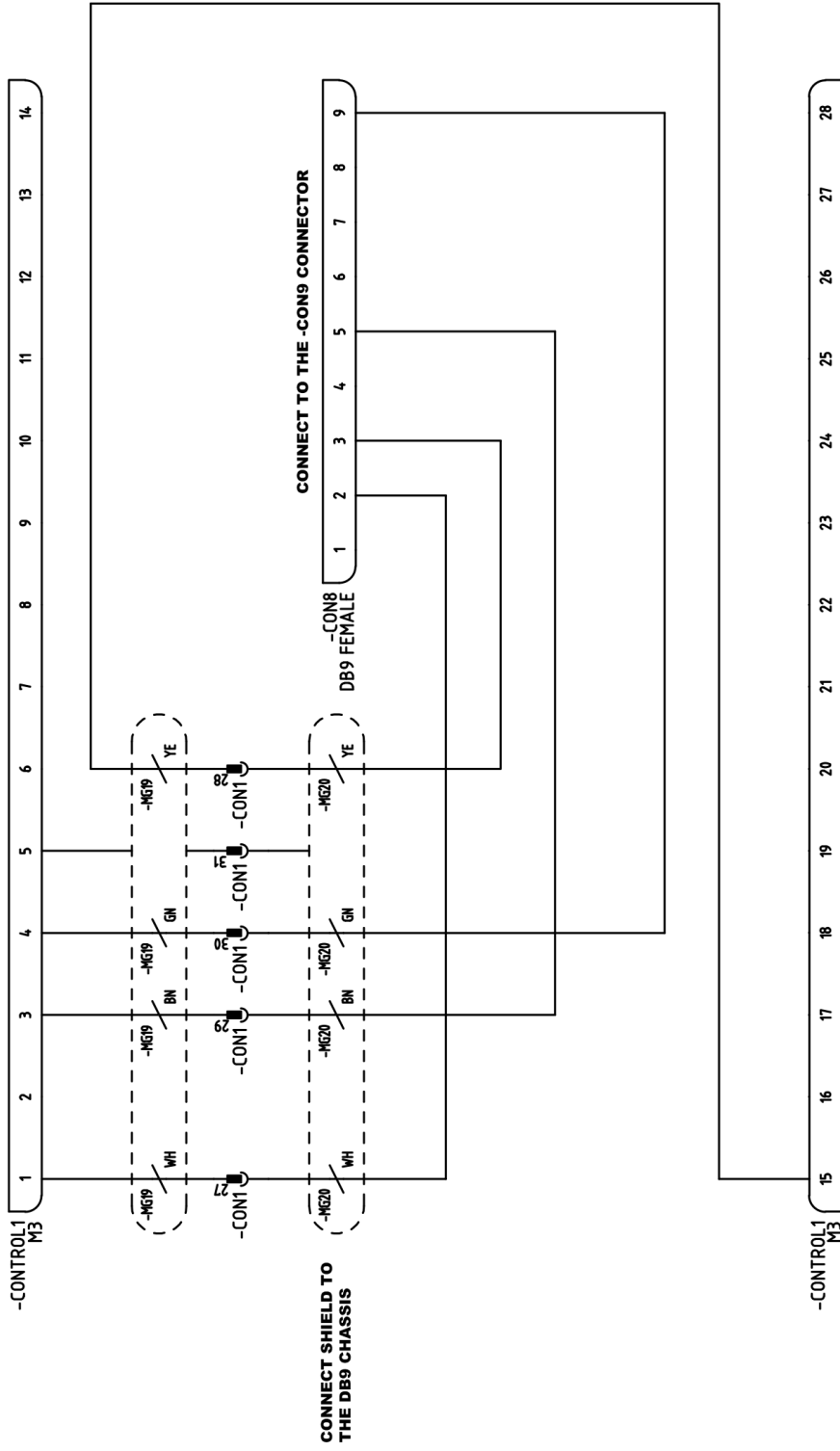

CONTROL 1 : S625 ESA NUMERIC CONTROL

ETHERNET EXTENSION CABLE 2

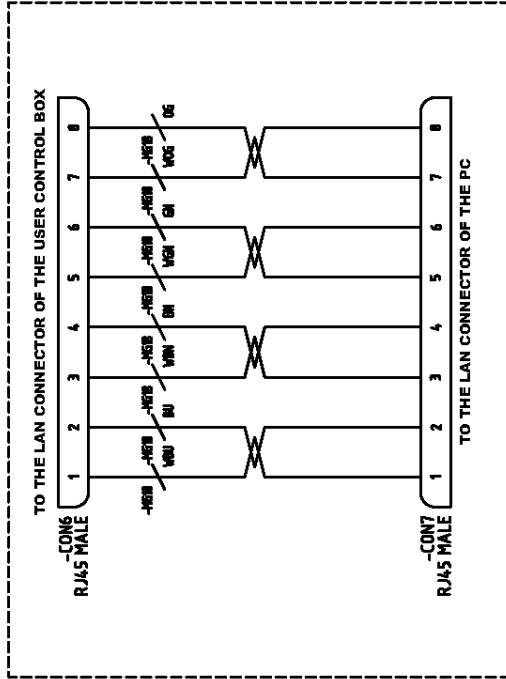

ETHERNET EXTENSION CABLE 1

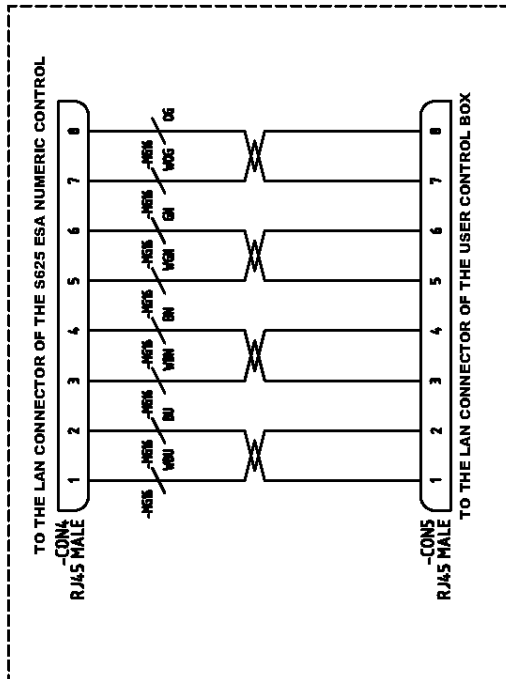

ROTARY ENCODER

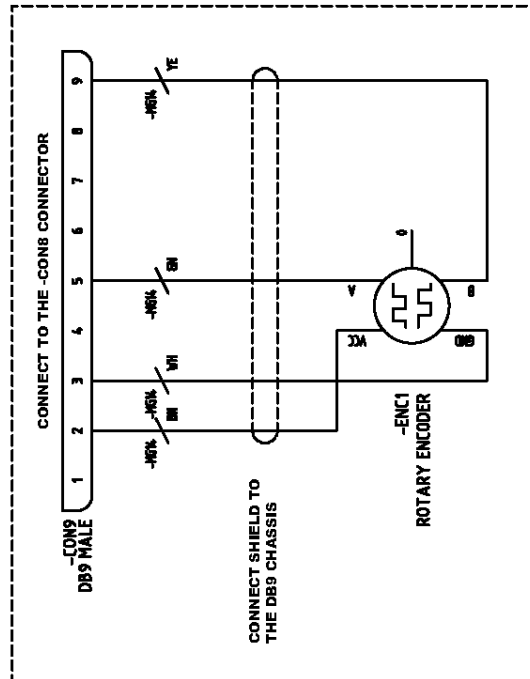

A10. Hydraulic map

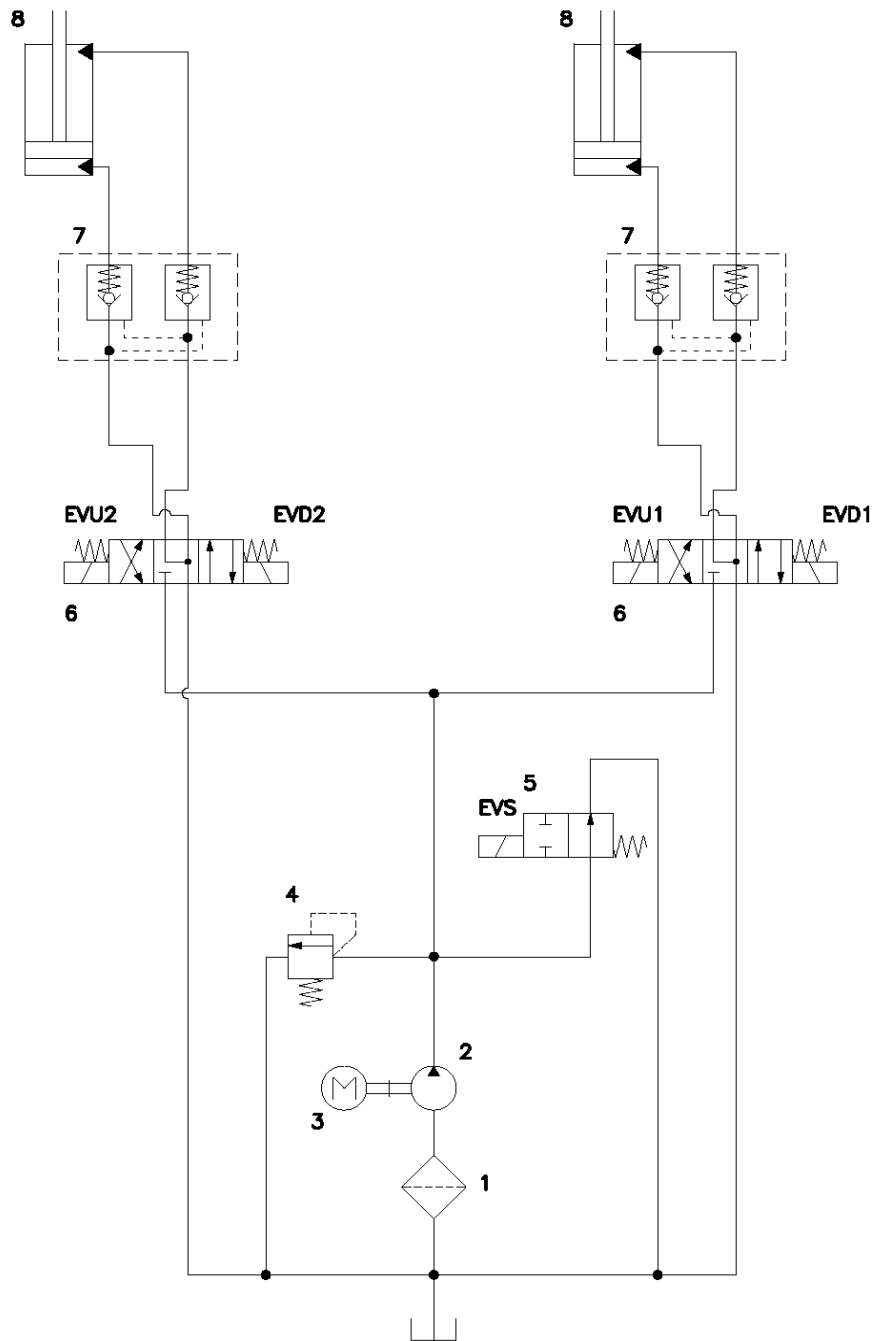

1. Suction Filter 3/8'
2. 1.5L Hydraulic Pump
3. Electric Motor 0.75Kw
4. Pressure Limiting Valve
5. Solenoid valve 3/2 Spring return
6. Solenoid valve 4/3 Center with circulation
7. Double Piloted non-return Valve
8. Double acting cylinders

OUR RANGE OF MACHINERY



IRON WORKERS



SECTION BENDING MACHINES



NON-MANDREL PIPE BENDER



HORIZONTAL PRESS BRAKE



TWISTING/SCROLL BENDING MACHINES



HYDRAULIC PRESS BRAKES



HYDRAULIC SHEAR MACHINES

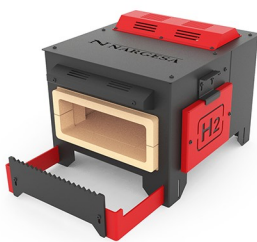

GAS FORGES



IRON EMBOSSING MACHINES



END WROUGHT IRON MACHINES



BROACHING MACHINES



POWER HAMMERS



PRESSES FOR LOCKS