

**N NARGESA®**

**TWISTING / SCROLL BENDING MACHINES**

**MT150A**



**50** years  
manufacturing industrial machinery

# TWISTING / SCROLL BENDING MACHINES

*Nargesa Scrollmakers were patented years ago by PRADA NARGESA, this makes us be a leading company in the manufacturing of this kind of machines. This is manufactured in a welded and mechanized steel monoblock. It has been conceived to work in cold steel, ideal for making all kind of pieces for the ornamental forging, balusters, scrolls...*

## GET A QUOTE

Please complete the following form. We'll contact you in less than 24 hours.

*Business days*

## HOW IT WORKS VIDEO

Video on how the machine works

## SOME OF OUR REMARKABLE CUSTOMERS



# TECHNICAL FEATURES

**Automatic Twisting Machine Nargesa MT150A, with a piece programmer, makes all kind of pieces for the ornamental forging, balusters, scrolls, etc... Maximum twisting capacity: square 20 mm, Maximum bending capacity: square 16 mm.**

- > Working method by twisting and flexion in COLD.
- > Machine suitable for small, medium and big production.
- > Safe and reliable transmission by a motor reducer with flat treated pinions, achieving a remarkable performance and least maintenance.
- > Perfect for making all kinds of ornamental standard parts and essential to make our own designs, a lot more demanded in the market. The pieces requested by architects, technicians and final customers, make it a very important tooling in a blacksmith workshop.
- > In order to make this kind of special job, Nargesa provides the user with the fitting plates, under request, so the very customer can make his own designs himself.

- > Maximum twisting capacity 20 mm or 3/4" inch.
- > Maximum bending capacity 16 mm or 5/8" inch.
- > Max twisting and bending capacity in flat bar, clod or handrail 35X10 mm or 1 1/4"X3/8" inch.
- > Possibility of buying the tooling for the machine in mm or inches.
- > Maximum continuous scrolling length 960 mm.
- > Engine power: 0,37Kw / 0,5 HP.
- > CNC programmer to repeat series, piece counter, automatic unbolt, memories...
- > Adjustable millimeter scale on its head to make all parts the same.
- > Electric panel command with double button, right and left , which makes it a very easy handling machine.
- > 2-phased tension: 230 V. Single phased.

*\* All our products are manufactured in our facilities in Spain. The hydraulic and electrical components are all standard from the best leading European trademarks, with technical assistance all over the world: Rexroth, Bosch, Roquet, Schneider Electric, LG, Telemecanique, Pizzato etc...*

## OUTSIDE DIMENSIONS

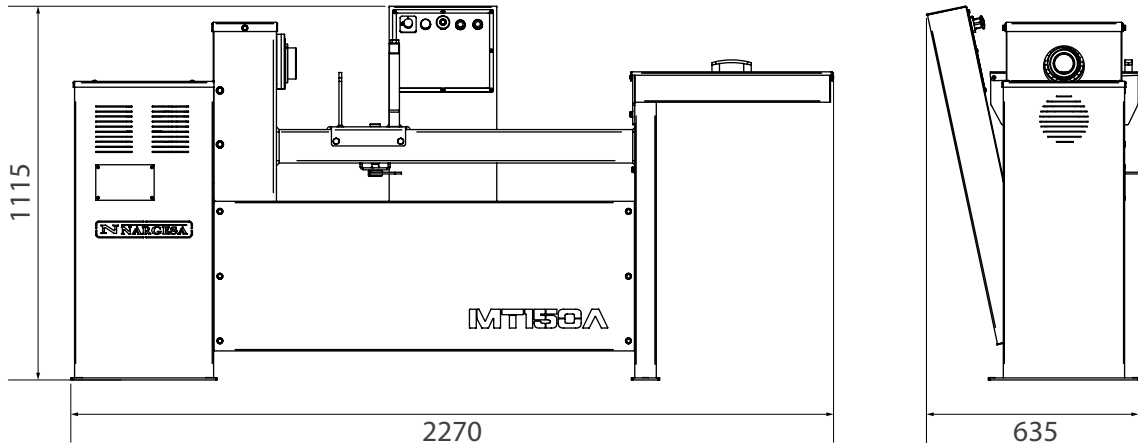

## PACKAGING CHARACTERISTICS

- Tariff Item Code: 84622990
- Lower bench palletized to easily transport the machine to the workplace or store it in case of lacking space.
- The machine is shipped fully assembled.
- Pallet made of steel and 3 layer cardboard box suitable for seafreight.
- Optional: Fumigated wooden box NIMF15.

### MT150A

|              |          |
|--------------|----------|
| Width        | 1800 mm  |
| Depth        | 650 mm   |
| Height       | 1280 mm  |
| Volume       | 1,498 m3 |
| Net Weight   | 260 Kg.  |
| Gross Weight | 290 Kg.  |

# STANDARD ACCESSORIES SUPPLIED WITH THE MACHINE

## Tooling to twist square bar 12mm and 18 mm or 1/4 and 5/8 inches Whitwort

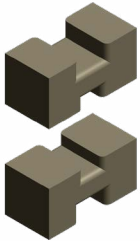

Units per machine: 4

> Tooling made of treated steel F1140 to make twisting in 12x12mm and 18x18mm square bar or 1/4x1/4" and 5/8x5/8" Inches Whitwort, in conventional carbon steel.

REF: 120-01-01-00074 (12x12mm and 18x18mm)

REF: 125-01-01-00100 (1/4x1/4" and 5/8x5/8" inches Whitwort)

*Standard tooling.*

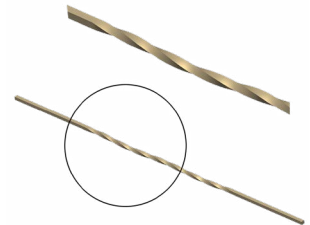

## Tooling to twist square bar 14 and 16 mm or 3/8 and 1/2 inches Whitwort

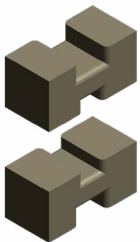

Units per machine: 4

> Tooling made of treated steel F1140 to make twisting on square bar 14x14mm and 16x16mm or 3/8x3/8" and 1/2x1/2" inches Whitwort, in conventional treated carbon.

REF: 120-01-01-00075 (14x14mm and 16x16mm)

REF: 125-01-01-00101 (3/8x3/8" and 1/2x1/2" inches Whitwort).

*Standard tooling.*

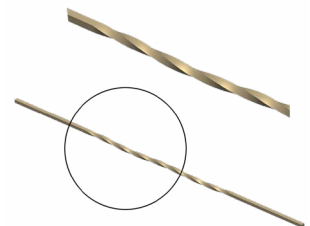

## Tooling to twist square bar 20mm and flat bar 35x10 mm or 3/4" and 1 1/4"x3/8" inches Whitwort



Units per machine: 4

> Tooling made of treated steel F1140 to make twisting on square 20x20mm and Flat bar 35x10mm or 3/4x3/4" and 1 1/4"x3/8" Inches Whitwort, in conventional carbon steel.

REF: 120-01-01-00076 (20x20mm and 35x10mm)

REF: 125-01-01-00102 (3/4x3/4" and 1 1/4"x3/8" Inches Whitwort)

*Standard Tooling.*

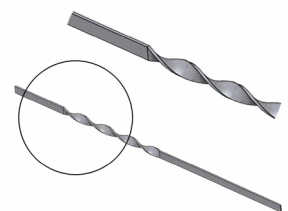

## Tooling for rings of 80mm.

---

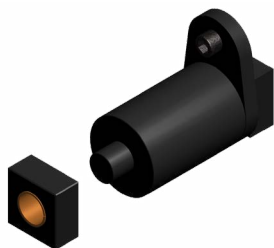

REF: 130-01-01-00124

- > Tooling made of steel F1140 to make rings with inner diameter 80mm either in round or square bar.
- > The spiral is cut and various rings can be obtained to be put between the balusters.

**Ring internal diameter:** 80mm.  
**Maximum capacity:** round or square 16mm.

*Standard tooling.*

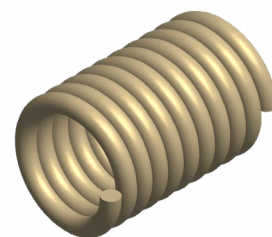

## Tooling for braiding round bars

---

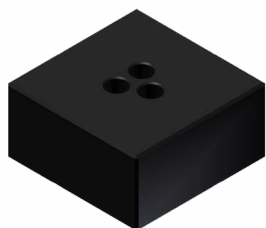

REF: 120-01-01-00085

- > Tooling made of treated steel F1140 to make braids using round rods, maximum three rods of 8mm diameter each.

**Maximum capacity:** 3 of 8mm.

*Standard tooling.*



## Spiral tooling diameter 120mm

---

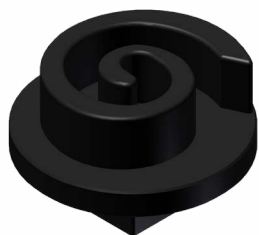

REF: 120-01-01-00060

- > Tooling made of treated steel F1140 to make the second operation of the spiral in flat bar, square or round.
- > Maximum 10mm thickness.

**Scroll external diameter:** 120mm.  
**Maximum capacity:** 40x8mm

*Standard tooling.*

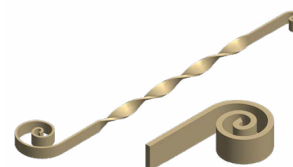

## Start spiral die diameter 100mm

---

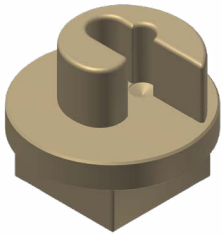

REF: 120-01-01-00093

- > Tooling made of treated steel F1140 to make the start of the spiral in flat bar, square or round.
- > Maximum 16mm thickness.

**Scroll external diameter:** 100mm.  
**Maximum capacity:** 40X10mm.

*Standard Tooling.*

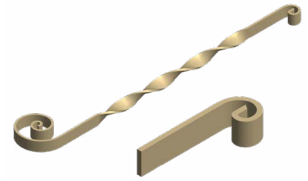

## Spiral tooling diameter 220mm

---



REF: 130-01-01-00125

- > Tooling made of treated steel F1140 to make the second operation of the spiral in flat bar, square or round.
- > Maximum 16mm thickness.

**Scroll external diameter:** 220mm.  
**Maximum capacity:** 40x10mm

*Standard tooling.*

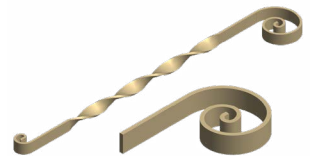

## Tooling for links and hooks

---

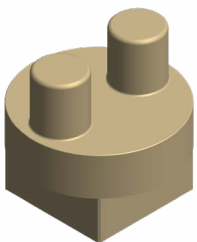

REF: 120-01-01-00110

- > Microfusion treated tooling to make all kinds of folding operations, hooks, links, hooks, chains, etc.
- > Flat bar 40x10mm
- > It folds all kind of material.

**Maximum capacity:** 16mm round or square.

*Standard tooling.*

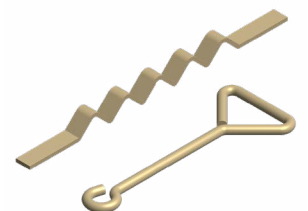

## Starting die for spiral diameter 80mm

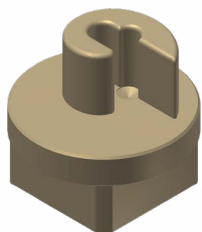

REF: 120-01-01-00094

- > Tooling made of treated steel F1140 to make the start of the spiral in flat bar, square or round.
- > Maximum 10mm thickness.

**Scroll external diameter:** 80mm.  
**Maximum capacity:** 40x8mm

*Standard Tooling.*

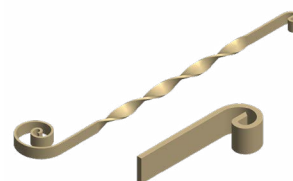

## OPTIONAL ACCESSORIES

### Flat Bent Rings Tooling Interior Diameter 96,100,110mm

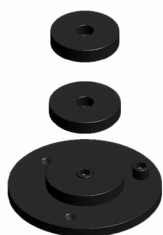

REF: 140-01-01-00001

- > Steel tooling to make bents in round and square, called British rail.

*Optional tooling.*

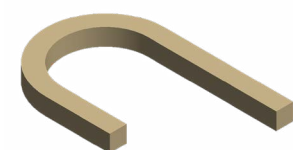

| Internal diameter | Maximum capacity     | Weight |
|-------------------|----------------------|--------|
| 96,100,110mm      | 16mm round or square | 10 Kg. |

### Belly top rail in tooling diameter 225mm

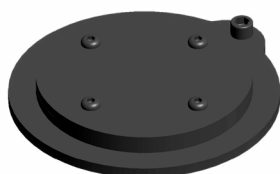

REF: 140-01-01-00002

- > Tooling to make the Belly Top railing Style, very used in balconies and windows.

*Optional Tooling.*



| Internal diameter | Maximum capacity     | Weight |
|-------------------|----------------------|--------|
| 225mm             | 16mm round or square | 12 Kg. |



## Flat bar folding tooling

---

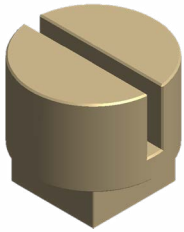

REF: 140-01-01-00003

- > Tooling made of treated steel to fold flat bars, handrails or clod of all kinds.
- > Bend with minimum external radios.

**Maximum capacity:** flat bar 40x10mm.  
**Weight:** 3,1 kg.

*Optional tooling.*

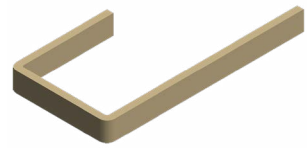

## Edge scroll tooling

---

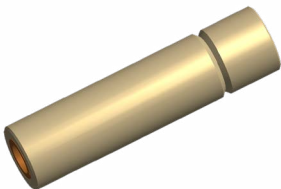

REF: 140-01-01-00004

- > Tooling made of treated steel to make edged scrolls or edged spirals in order to give it a different aspect, it's very used in some countries.

**Maximum capacity:** 16mm round or square  
**Weight:** 0,75 kg

*Optional tooling.*



## Baskets tooling MT150A

---

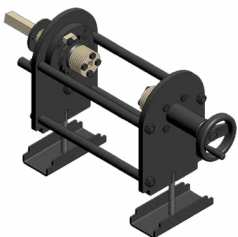

REF: 140-01-01-00005

- > Tooling to make ornamental baskets of all kinds in different sizes, in round or square bars.
- > Available tooling for millimeter and inch square sizes

**Maximum capacity:** 4mm in square or 10mm in round bars.  
**Weight:** 45kg.

*Optional tooling.*



*Instructions book. Millimetres*  
*Instructions book. Inches*

## MT150A

- > Maximum twisting capacity 20 mm or 3/4" inch.
- > Maximum bending capacity 16 mm or 5/8" inch.
- > Maximum twisting and bending capacity in flat bar, clod or handrail 35X10 mm or 1 1/4"X3/8" inch.
- > Maximum continuous scrolling length 960 mm.
- > Adjustable rotation speed from 0 to 9 r.p.m.



## MT500A

- > Maximum twisting Capacity 40 mm or 1 3/8" inches.
- > Maximum bending capacity: 25 mm or 1" inches.
- > Maximum scrolling and bending capacity in flat bar, clod or handrail 50x10 mm or 2"x 3/8" inches.
- > Maximum continuous twisting length: 1.620 mm.
- > Adjustable rotation speed from 0 to 10 r.p.m.



# OUR RANGE OF MACHINERY



IRON WORKERS



SECTION BENDING  
MACHINES



NON-MANDREL PIPE  
BENDER



HORIZONTAL PRESS  
BRAKES



TWISTING/SCROLL  
BENDING MACHINES



HYDRAULIC PRESS  
BRAKES



HYDRAULIC SHEAR  
MACHINES



GAS FORGES



IRON EMBOSING  
MACHINES



END WROUGHT IRON  
MACHINES



BROACHING MACHINES



POWER HAMMERS



PRESSES FOR LOCKS

## WARRANTY

Nargesa machines have 3 years warranty provided that the customer registers it in our website. Otherwise it would be only one year warranty. This one encloses any manufacturing default all along these 3 years for components. Any misuse is excluded from this condition. Labor, back and forth shipping and any eventual repair, are not included in this warranty.

Partner companies



Airpharm

## SHIPMENT EVERYWHERE

Nargesa will arrange transport up to final destination, whenever the customers asks for so. There is also the possibility for the customer to arrange the shipment himself with his own agency.

## TECHNICAL ASSISTANCE

All our customers have access to technical support quickly and efficiently. 90% of incidences are solved out on the phone, mail, Skype or videoconferencing in less than 24hours. In case of needing presencial technical assistance, we may as well send a technician to the customer's facilities.

Follow us on

---

### PRADA NARGESA, S.L.

Ctra. De Garrigàs a Sant Miquel s/n  
17476 Palau de Santa Eulalia (Girona) Spain  
Tel. +34 972 568 085

[www.nargesa.com](http://www.nargesa.com)

[nargesa@nargesa.com](mailto:nargesa@nargesa.com)



---

This information might undergo changes