



HYDRAULIC PRESS BRAKE CNC

MP3003CNC

 4.0 Technology



VIDEO MACHINE OPERATION

Machine performance video.

REQUEST ADJUSTED QUOTATION

Please fill up the following form. We will contact you in less than 24 hours.
Working days.

SOME OF OUR CUSTOMERS

Our customer's endorsement is our best business card



CERTIFICATES AND ACCREDITATIONS

Some of the certificates that support our processes and benefit our customers



INNOVATIVE SME

Valid until May 31st 2026



**CONCESSION
OF AUTHORIZED
EXPORTER
AUTHORIZATION**

ESEAOR23000312

NARGESA HYDRAULIC PRESS BRAKES

The new generation of Nargesa CNC hydraulic press brakes takes sheet metalworking to a new level, offering outstanding efficiency and precision. With a chassis of welded, stabilized and machined steel, external design featuring stripped-down lines for a solid appearance, and improved structural calculations, these new hydraulic press brakes set themselves up as the new cornerstone for the sheet metalwork industry.

Fitted with high-specification CNC control, the operation of these complex machines is now easier and more intuitive than ever before. Its colour, high-resolution touch screen graphics interface and powerful CPU enable the most complicated bending operations to be processed effortlessly and sophisticated algorithms to be calculated in mere microseconds, so you get the highest performance out of these pieces of engineering excellence.

Among the elements that make the new Nargesa CNC hydraulic press brakes ideal for the sheet metalwork industry, we highlight the following: the adaptive electronic pressure control system which ensures the force required for each operation; the chassis bending electronic compensator which gives optimum bending precision with different sheet metal lengths; the micrometric resolution optical encoder which permits perfect positioning of the vertical axis of bending; the sophisticated electronic compensation system for hydraulic oil temperature, which can be configured using software to offer repeat bending at different working temperatures; the self-monitoring safety hydraulic system contained in a single unit which provides manometer pressure information at all times with optics indication of the status of valves and sensors, transmitting movement to the vertical bending axis ensuring precision to within 0.01mm, and a servo motor driven back gauge with maximum precision recirculating ball screw guide which reduces X and R axis positioning error to less than 0.05 mm and the option for manual adjustment of the Z axis; and 2.0 connectivity for seamless LAN integration of machines via a 10/100 Mbit Ethernet connection for the remote control, management, diagnosis and update of machines. A full range of specifications designed to provide maximum performance using technological components of the highest quality to make the operator's job easier.

* All products Nargesa are according to the European CE regulations for the manufacturing of industrial machinery.

STANDARD EQUIPMENT INCLUDED

- Automatic control of vertical bending axis (Y axis).
- Back gauge fitted with BOSCH REXROTH recirculating ball screw guides, ESA servo motor automatic control of horizontal axis (X axis), manual control of vertical axis (R axis) and manual control of transverse axis (Z axis) with parallel alignment and curvature adjustment.
- Promecam punch clamping system with segmented flanges.
- Euro Promecam system with die guide rail.
- Promecam punch, reference PS.135.85.R08, Induction tempered in working and grinding zones.
- Promecam die, reference M.460.R, Induction tempered in working and grinding zones.
- ESA numerical control, reference S630.
- Adaptive electronic pressure control.
- Chassis bending electronic compensator.
- GIVI MISURE high-precision optical encoder, 0.005 mm resolution.
- Atos synchronized hydraulic unit with 24 VDC redundant safety valves with optics and pressure indication.
- Electronic compensation of hydraulic oil temperature.
- Front arms which slide on linear recirculating ball screw guides for optimum sheet metal grip.
- Side doors with electronic safety control.
- High-frequency laser sensor system unaffected by external light sources.
- Software-configured electronic muting system.
- LED directional light strip for bending zone.
- Ethernet 10/100 Mbit LAN connectivity.
- USB 2.0 ports and VGA connector for updates, backup and peripherals.
- 10" colour touchscreen graphics interface, high-resolution, multi-language (over 20 languages).
- Basic software installed in the CNC control containing a full library of Promecam punches and dies, and for creating, modifying and editing bending programs in numerical mode, which can be enlarged with additional software modules.
- Complete software for Windows PC with bending simulator and CNC optimiser for 2-D graphics programming of bending sequence, with full library of Promecam punches and dies.

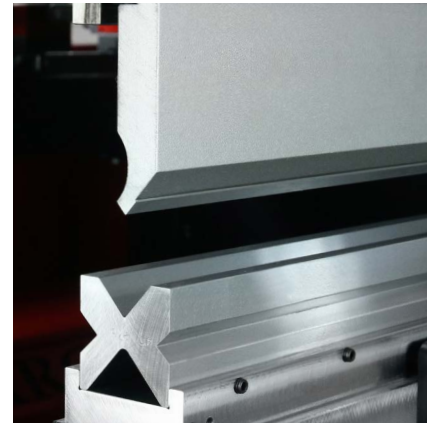
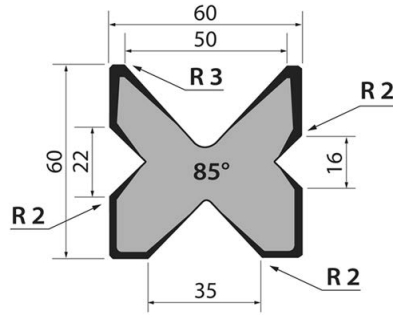
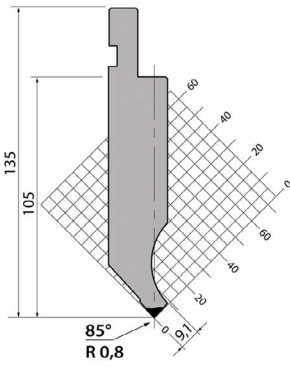

Standard punch and die

Nargesa press brakes models are equipped with the standard punch PS.135.85.R08 Ref. Promecam and the standard die M.460.R.

Material type: C45

Mechanical resistance: 560 - 710 N/mm²

Hardness: 54 - 60 HRC

Length MP1500CNC: 835 + 670 mm

Length MP3003CNC: 835 + 835 + 835 + 645 mm

Punches and dies

We have a wide catalogue of punches and dies of all kinds in Nargesa. You will be able to take a closer look at all the available sort and sizes our website.



Structure

The high-precision welded, stabilised and machined steel chassis has been designed to eliminate any types of stress.

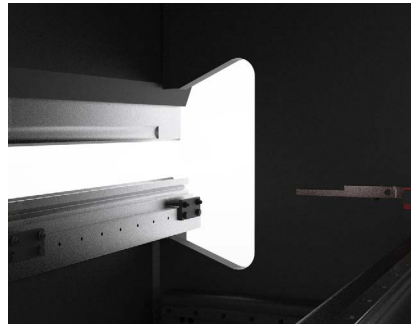

S-bend

The S-bend included in the hydraulic press brake design enables complex pieces to be produced, facilitating bending at both ends of the machine.



LED Lighting

The LED directional light strip for lighting the bending zone permits the operator to work in optimum visibility conditions.

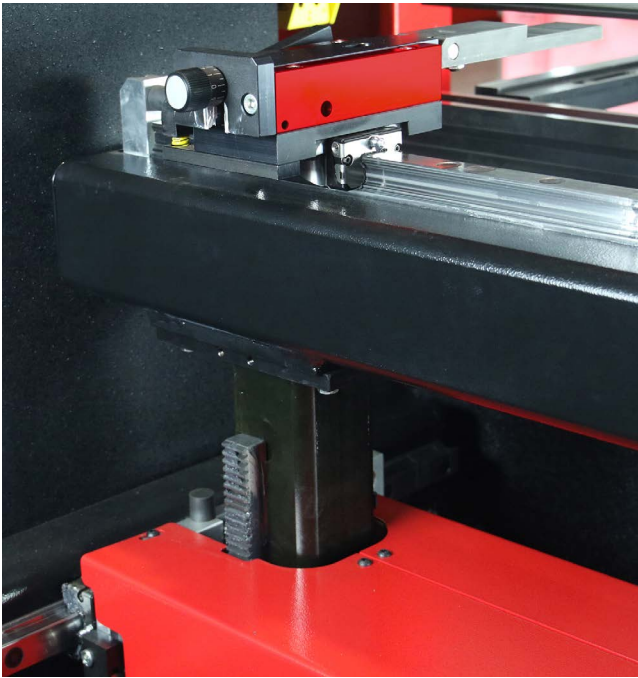

Back gauge

The back gauge is fitted with ESA servo motors and precision BOSCH REXROTH recirculating ball screw guides which permit automatic positioning of X and R axes with 0.05 mm precision. It also has a manual adjustment system for the Z axis which enables the gauge callipers to be slid easily along a guide with recirculating ball screw system.

The parallel alignment of the gauge callipers with the press brake punch holder plate is adjusted manually using micrometers to ensure maximum precision. In addition there is a mechanical offset system for Z axis curvature so that deviations can be corrected.

- High speed measurement search: 565 mm/seg
- Servo motor 1 Nm to 5000 rpm.
- Back gauge displacement 600 mm.

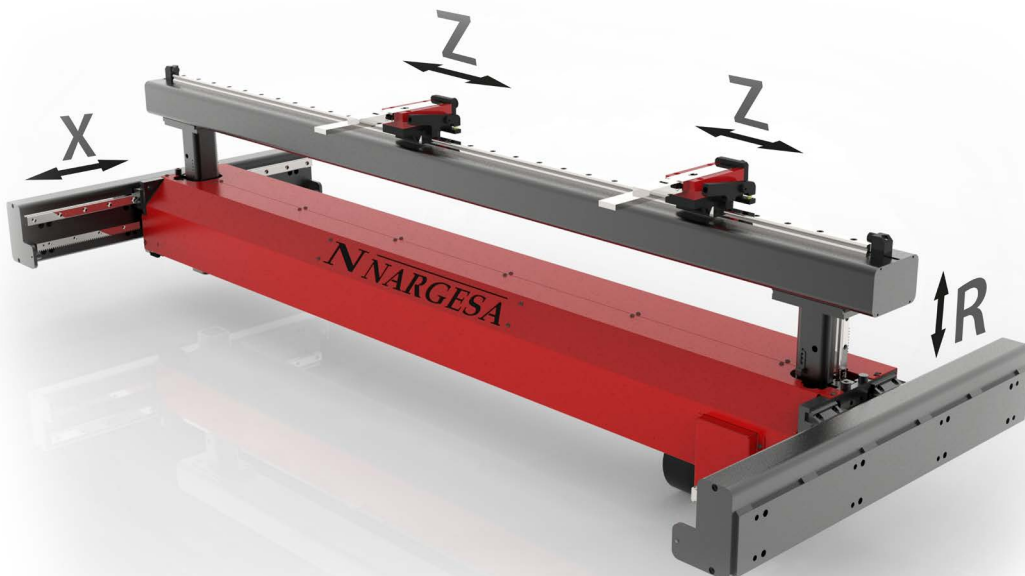

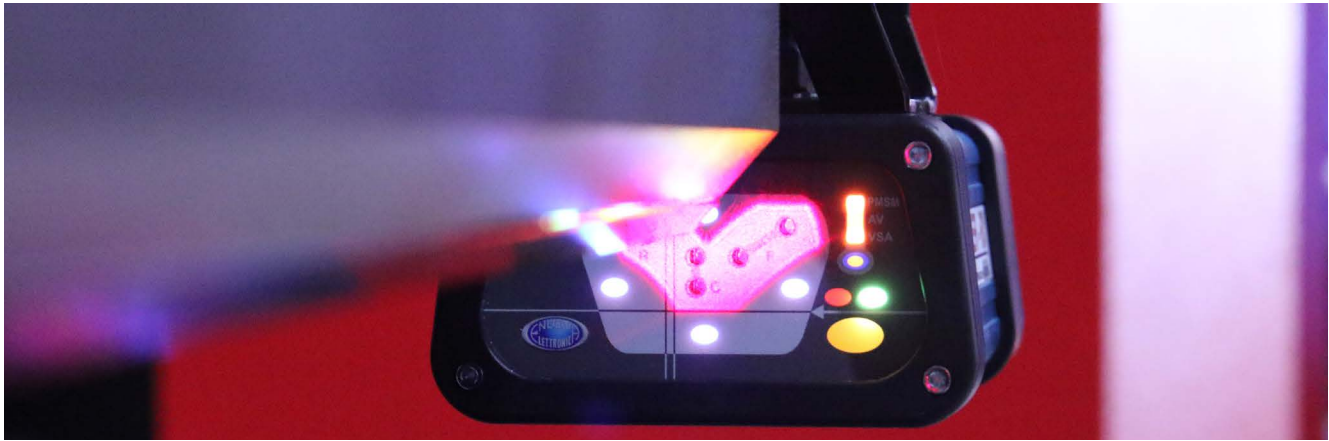

Laser sensor

The laser sensor system built in to the press brake has a metric guide to facilitate vertical adjustment and can easily be lifted up and removed when work tools (punches and dies) need changing.

The system includes two electronically controlled high-frequency laser emitters and receivers which are able to recognise and ignore any external light source and are thus protected from interference by any other lighting, whether natural or artificial.

In addition, for complex bending operations on sheet metal with protruding areas which prevent the piece

from being produced in the normal way, the laser sensor can be disabled by means of a push-button on the front of the machine which causes the press brake to operate at low speed.

Moreover, the inclusion of electronic muting enables the laser sensor sweep extremities to be replaced with a novel parameterised system, where CNC control software controls the activation position of muting automatically at all times in relation to punch size and sheet metal thickness.

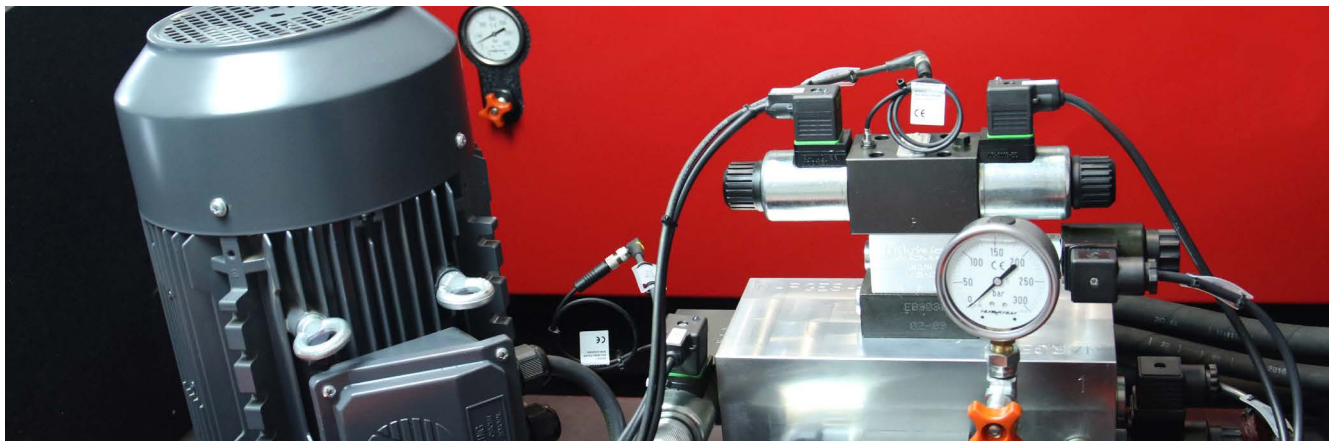

Hydraulic unit

Centralising all the hydraulic components in a single unit improves their maintenance and management, giving a self-monitoring, redundant hydraulic system which provides working pressure information at all times by means of a manometer, and optics indication of the status of valves and sensors.

In addition to the mechanical pressure limiter, electromagnetic safety valve and electromagnetic control valves for raising and lowering the punch holder plate, the hydraulic unit is fitted with two

proportional servo valves, one for dynamic pressure regulation (servo valve E1) according to the requirements of each bending operation, and another for regulating the speed of the vertical bending axis (servo valve D1) to ensure highest working precision at all times.

The electromagnetic valves are controlled at 24 VDC and have an LED light indicating activation status and an inductive position sensor with LED light for safety control.

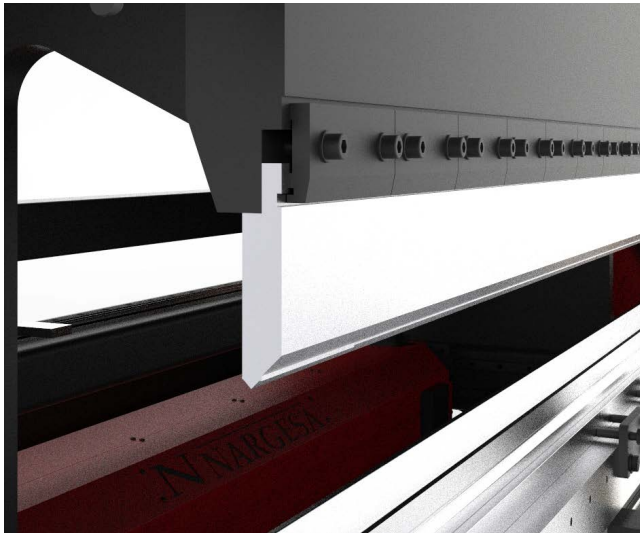

Promecam punch clamping system

The Promecam punch clamping system with segmented flanges can be taken apart and adjusted from the front by means of screws. The Euro Promecam guide rail system permits dies to be changed quickly without needing tools.



Precision bending

For maximum bending precision a GIVI MISURE high-resolution (0.005 mm) optical encoder is used, which controls the vertical position of the bending axis (Y axis) for excellent reliability in each operation. Combined with control of lowering speed, this ensures punch holder plate vertical axis precision for bending operations and gives positioning error of less than 0.01 mm.

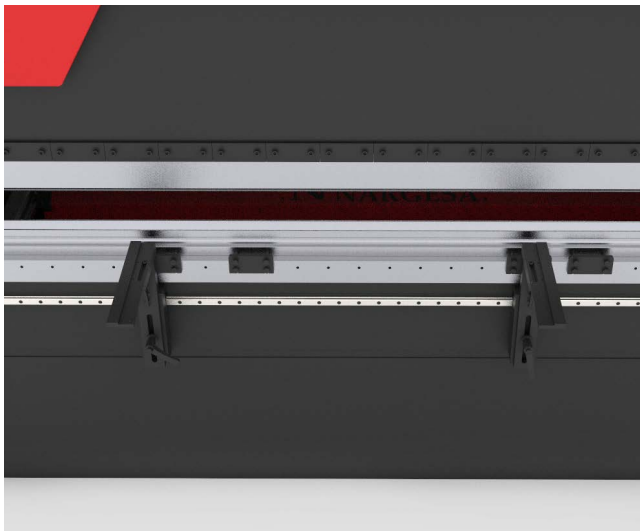

Sliding arms

The front arms which slide by means of recirculating ball screw guides enable the sheet metal to be held in position securely and can be fully adjusted both horizontally and vertically by hand.



Side doors

The side doors of the hydraulic press brake have an electronic safety control device to manage their position and give information to user at all times via on screen messages, and offer a large opening angle which makes it easier to change punches and dies whenever necessary. In addition, their design combines steel plate with a methacrylate viewing window so precision bending operations can be inspected in complete safety.



CNC Control

The powerful ESA S630 CNC control system has outstanding processing capacity which permits up to four axes to be managed, interpolated in any combination Y, X, R and Z, providing solutions for the most complex bending operations, and a flash memory for 5000 programs and a full library of Promecam punches and dies.

CNC control is the core which runs all the systems and which now includes, amongst other innovative solutions, the adaptive electronic pressure control which calculates the force required for each operation and thus lengthens the life cycle of punches and dies; the electronic chassis bending compensator which plays a part in optimising bending precision with different lengths of sheet metal; and the efficient electronic system for hydraulic oil temperature compensation, permitting repeat bending operations to be performed at different working temperatures.

The 10" high-resolution (1024 x 600 pixels) colour graphics touch screen responds efficiently to user operations and provides clear and detailed information at all times. It enables programs to be edited graphically or numerically, new dies and punches to be managed, edited and added to existing libraries, bending sequences to be controlled, bending collisions to be controlled, bending simulations to be done, sheet metalwork to be calculated and machine sensors and inputs/outputs to be diagnosed in an intuitive and straightforward manner. Moreover it offers 20+ display language options, so the requirements of the majority of users are covered.

In terms of connectivity, the CNC ESA S630 control turns the new Nargesa CNC hydraulic press brakes into just another item of equipment in the company LAN thanks to the Ethernet 10/100 Mbit port which enables remote control, management, software updates and diagnosis to be performed. In addition, USB 2.0 ports and a VGA connector allow CNC software to be updated locally and external peripherals to be connected, such as backup units, QWERTY keyboards, mouse or external display screen.



Sheet metalwork and bending sequence calculations

The complex algorithms processed by the CNC control enable the total worked length of the sheet metal to be obtained accurately according to the bending program. Furthermore, bending sequence management makes it possible to select the most suitable option for producing each piece, ensuring greatest ease for user who also has invaluable help in the form of the efficient 2-D visual bending simulator, which displays the positioning of the sheet metal in the press brake during each stage of the process, in addition to graphics display of the progress of different bending operations being performed.

Naturally, the CNC control also takes care of running collisions calculation at all times, thus providing precise indication of any potential collision problem between the sheet metal to be bent, the punch and dies used, and the structure of the machine.

PC software

CNC ESA S620 control software can also be installed on any computer running the current version of the Windows operating system and has the same interface as the machine, thus minimising the time required to become familiar with how it works and permitting two-way export of programs and tools between PC and machine.

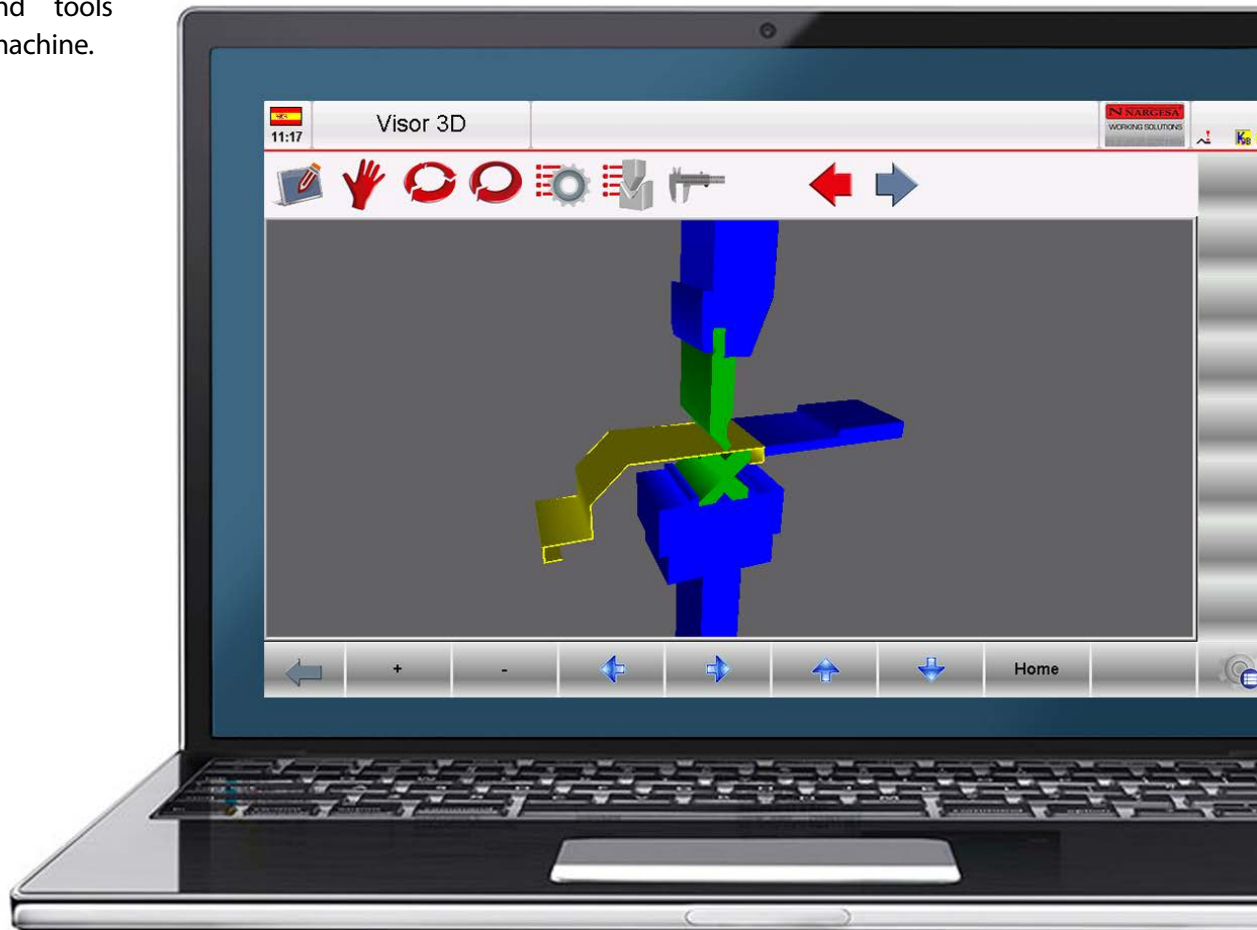

TYPES OF BENDING

CNC control also provides precise management of different types of bending, such as:

1

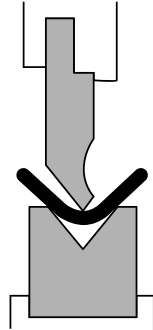

1. Air bending: where the sheet metal being bent with the punch does not reach the very bottom of the die. This enables different bending angles to be obtained using the same tools, which requires extreme precision to guarantee a perfect result.

2

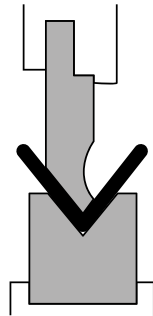

2. Bottoming: the punch forces the sheet metal to the very bottom of the die. The bending angle obtained depends on the tools used.

3

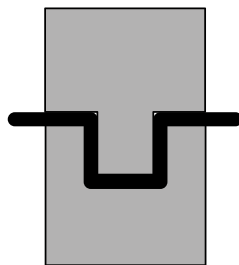

3. Stamping: the sheet metal can be folded upon itself to give higher strength in specific areas.

4

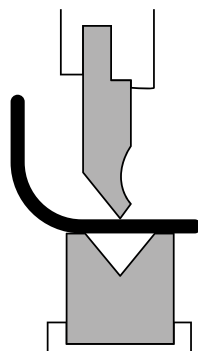

4. Roller pressing: this enables different curve radii to be obtained in a sheet by means of subjecting it to multiple bending sequences.

DETAILED FEATURES



MP1500CNC

Tension 230/400 V

Dimensions 2110x1880x2210 mm

Weight 4900 Kg























MP3003CNC

Tension 230/400 V

Dimensions 3720x1930x2810 mm

Weight 9100 Kg

Engine Power (Kw)		5,5
		9,5
Hydraulic power (Tn)		40
		120
Max. Punch displacement (mm)		200
		160
Inner folding length (mm)		1250
		2700
Total folding length (mm)		1500
		3125
Back gauge displacement (mm)		600
		600
S-bend (mm)		270
		320
Punch working speed (mm/s)		8,3
		6,7
Return speed of the punch (mm/s)		120
		43,4
Lowering speed of the punch (mm/s)		200
		26,8

EXTERNAL DIMENSIONS

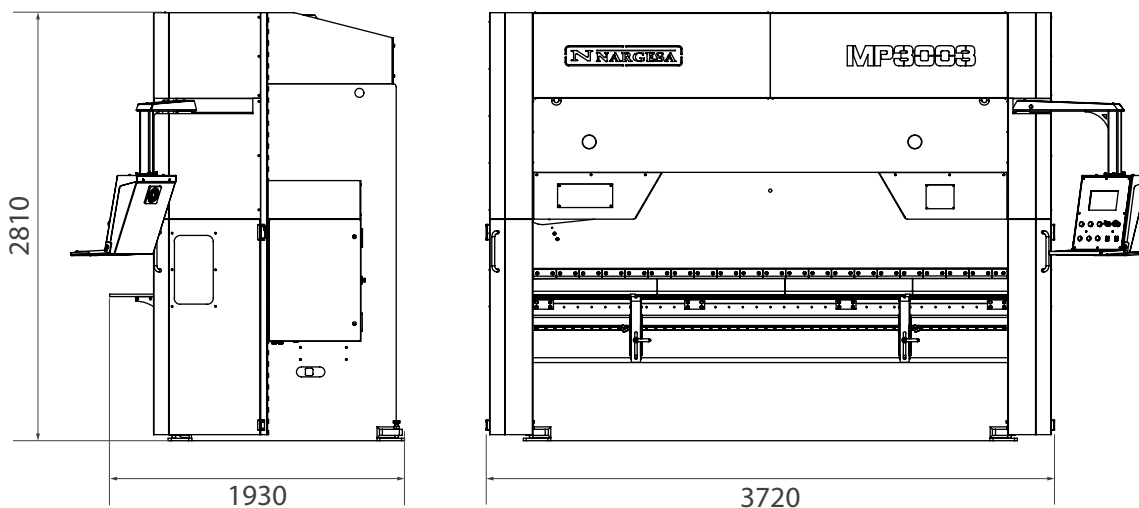

CHARACTERISTICS OF THE PACKAGING

- Tariff Item Code: 84622300
- The machine is delivered completely assembled.
- Packing with retractile film.
- Optional: Complete wooden packing NIMF15.

MP3003CNC

Width:	3720mm
Length:	1630mm
Height:	2810mm
Volume:	17m3
Nett Weight:	9100Kg
Gross Weight:	9150Kg

OPTIONAL TOOLING



Graphics and bend calculation in CNC

Optional installation in the basic CNC control of software modules with bending simulator and CNC optimizer for the creation of 2-D graphics of bending program with the most efficient sequence.

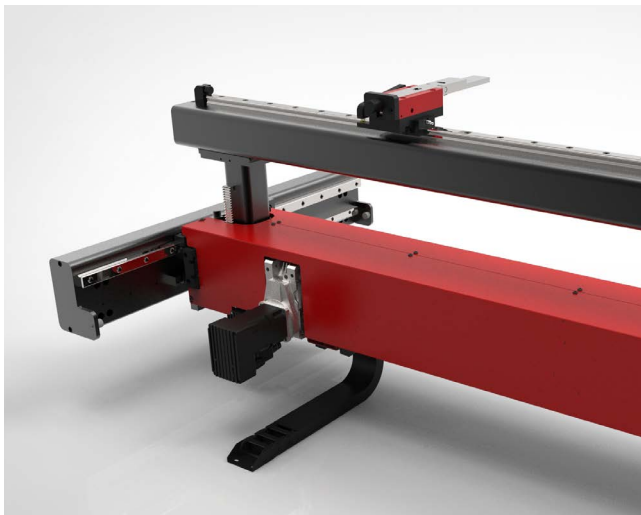

Motorised R axis

Motorised vertical axis (R axis) of back gauge, controlled by ESA servo motor, with the features described below:

- High speed positioning: 130 mm/sec.
- High precision recirculating ball screw guides.
- Servo motor with 1 Nm torque at 5000 rpm.
- Maximum displacement of axis: 150 mm.
- Mechanical precision: 0.05 mm.



Z1-Z2 axis

The Z1-Z2 axis enables us to optimize the set up time of the machine. The CNC optimizes the position of gauges Z1 and Z2 according to the dimensions of the piece and the position of the tools.

- High search speed of size: 400mm / sec
- Linear guides for recirculation of high precision balls
- 1 Nm to 5000 rpm servo motors.
- Stroke axis Z1, Z2: 2600 mm.
- Mechanical precision: 0.05 mm.

* In case of choosing this option the machine will be delivered with the ESA 640 CNC,

* This option is only available if you have chosen the following optional accessories: R-axis and Graphics and CNC bending calculation

All accessories for Nargesa Press Brakes are manufactured according to international standards. Therefore, guaranteeing high resilience and tensile strength.

Materia Type	Mechanical resistance of the material and the tool body	Hardness of the material and the tool body	Hardness of the operating surfaces after induction hardening
● 42CrM04	900 - 1150 N/mm2	29.1 - 36.9 HRC	54 - 60 HRC
● C45	560 - 710 N/mm2	12 - 15.5 HRC	54 - 60 HRC

Punches

For different sizes, please ask the manufacturer.

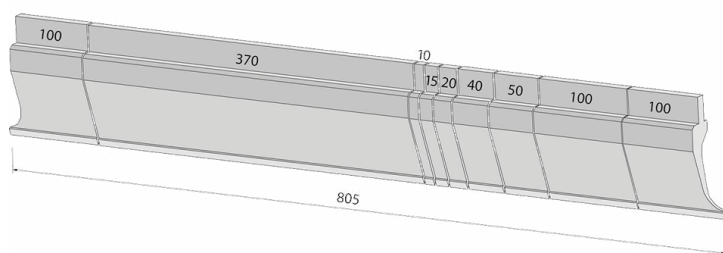

Segmented 805 mm

100, 370, 10, 15, 20, 40, 50, 100, 100 mm

Segmented 795 mm

100, 250, 20, 25, 30, 35, 40, 45, 50, 100, 100 mm

Segmented 800 mm

100, 10, 15, 20, 40, 50, 165, 300, 100 mm

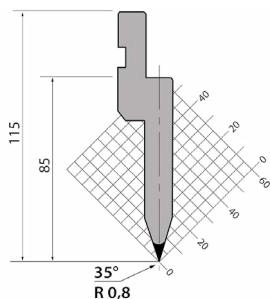

● PU.85.35.R08

835 mm.
415 mm.
795 mm. Segmented
805 mm. Segmented

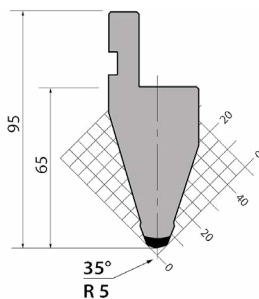

● P.95.35.R5

835 mm.
415 mm.
795 mm. Segmented
805 mm. Segmented

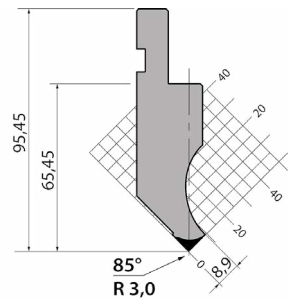

● PK.95.85.R3

835 mm.
415 mm.
795 mm. Segmented
805 mm. Segmented

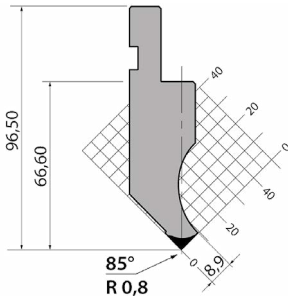

● **P.97.85.R08**

835 mm.
415 mm.
795 mm. Segmented
805 mm. Segmented

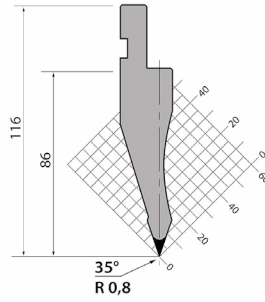

● **P.116.35.R08**

835 mm.
415 mm.
795 mm. Segmented
805 mm. Segmented

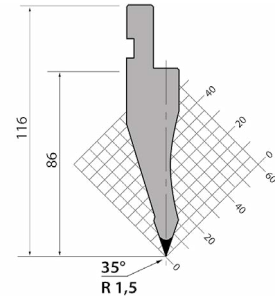

● **P.116.35.R15**

835 mm.
415 mm.
795 mm. Segmented
805 mm. Segmented

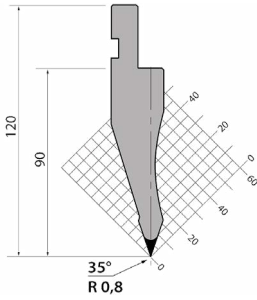

● **P.120.35.R08**

835 mm.
415 mm.
795 mm. Segmented
805 mm. Segmented

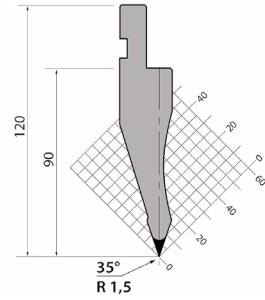

● **P.120.35.R15**

835 mm.
415 mm.
795 mm. Segmented
805 mm. Segmented

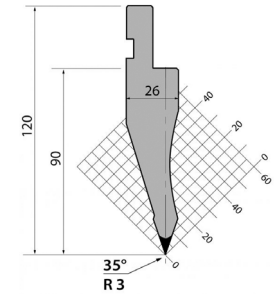

● **P.120.35.R3**

835 mm.
415 mm.
795 mm. Segmented
805 mm. Segmented

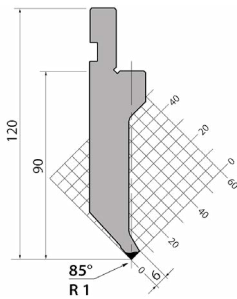

● **P.120.85.R1**

835 mm.
415 mm.
795 mm. Segmented
805 mm. Segmented

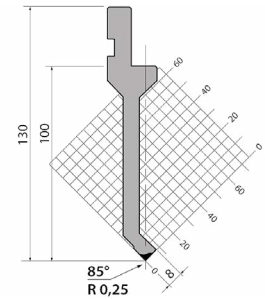

● **P.130.85.R025**

835 mm.
415 mm.
795 mm. Segmented
805 mm. Segmented

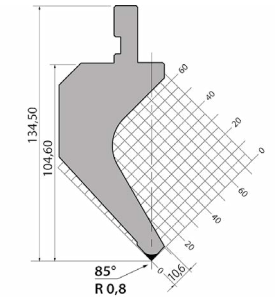

● **PK.135.85.R08**

835 mm.
415 mm.
795 mm. Segmented
805 mm. Segmented

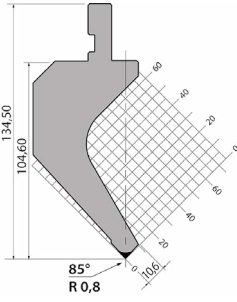

● **P.135.85.R08**

835 mm.
415 mm.
795 mm. Segmented
805 mm. Segmented

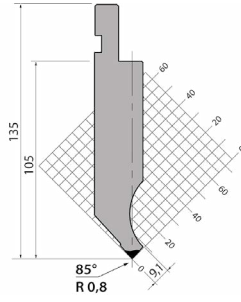

● **PS.135.85.R08**

835 mm.
415 mm.
795 mm. Segmented
805 mm. Segmented

Dies

For different sizes, please ask the manufacturer.

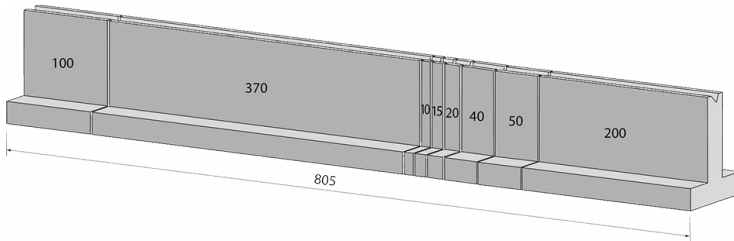

Segmented 805 mm

100, 370, 10, 15, 20, 40, 50, 200 mm

Segmented 795 mm

100, 250, 20, 25, 30, 35, 40, 45, 50, 200 mm

Segmented 495 mm

170, 100, 50, 45, 40, 35, 30, 25 mm

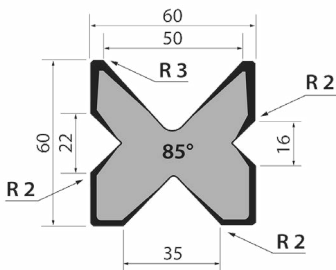

● **M.460.R**

835 mm.
415 mm.
795 mm. Segmented
805 mm. Segmented

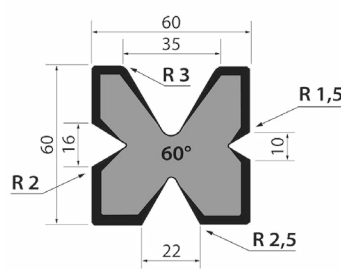

● **M.460.60**

835 mm.
415 mm.
795 mm. Segmented
805 mm. Segmented

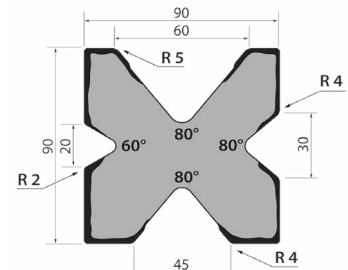

● **M.490**

835 mm.
415 mm.
795 mm. Segmented
805 mm. Segmented

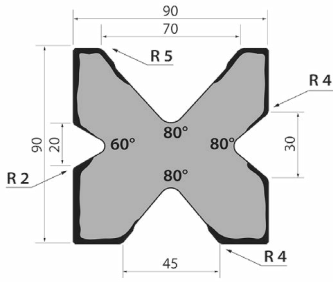

● **M.490.70**

835 mm.
415 mm.
795 mm. Segmented
805 mm. Segmented

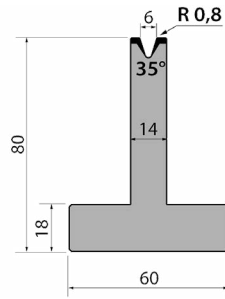

● **T80.06.35**

835 mm.
415 mm.
795 mm. Segmented
805 mm. Segmented

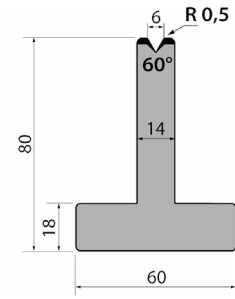

● **T80.06.60**

835 mm.
415 mm.
795 mm. Segmented
805 mm. Segmented

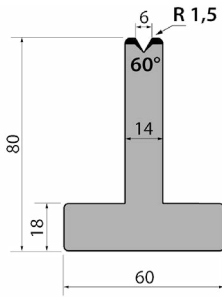

● **TR80.06.60**

835 mm.
415 mm.
795 mm. Segmented
805 mm. Segmented

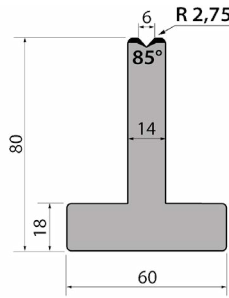

● **T80.06.85**

835 mm.
415 mm.
795 mm. Segmented
805 mm. Segmented

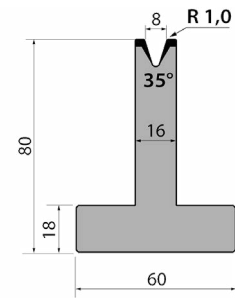

● **T80.08.35**

835 mm.
415 mm.
795 mm. Segmented
805 mm. Segmented

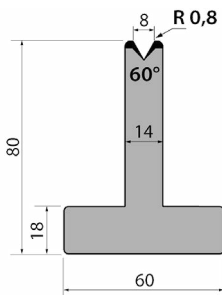

● **T80.08.60**

835 mm.
415 mm.
795 mm. Segmented
805 mm. Segmented

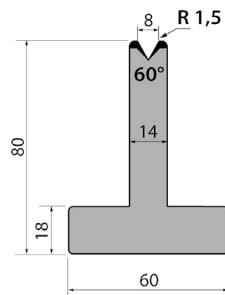

● **TR80.08.60**

835 mm.
415 mm.
795 mm. Segmented
805 mm. Segmented

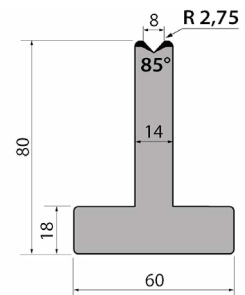

● **T80.08.85**

835 mm.
415 mm.
795 mm. Segmented
805 mm. Segmented

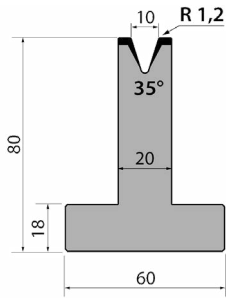

● **T80.10.35**

835 mm.
415 mm.
795 mm. Segmented
805 mm. Segmented

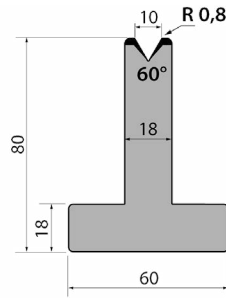

● **T80.10.60**

835 mm.
415 mm.
795 mm. Segmented
805 mm. Segmented

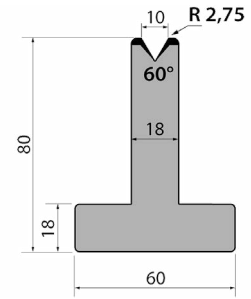

● **TR80.10.60**

835 mm.
415 mm.
795 mm. Segmented
805 mm. Segmented

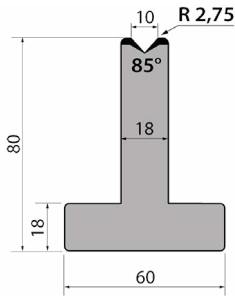

● **T80.10.85**

835 mm.
415 mm.
795 mm. Segmented
805 mm. Segmented

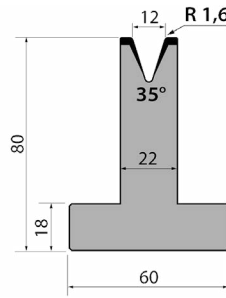

● **T80.12.35**

835 mm.
415 mm.
795 mm. Segmented
805 mm. Segmented

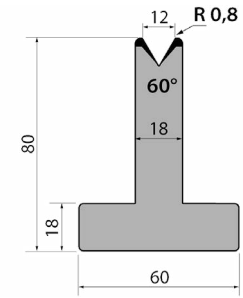

● **T80.12.60**

835 mm.
415 mm.
795 mm. Segmented
805 mm. Segmented

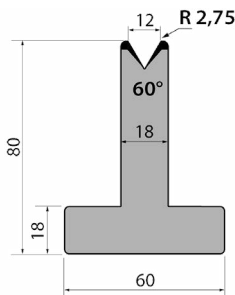

● **TR80.12.60**

835 mm.
415 mm.
795 mm. Segmented
805 mm. Segmented

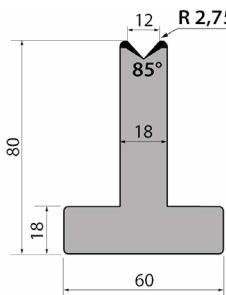

● **T80.12.85**

835 mm.
415 mm.
795 mm. Segmented
805 mm. Segmented

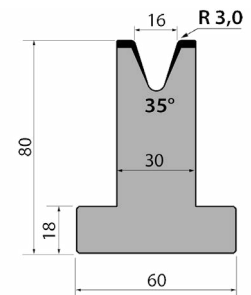

● **T80.16.35**

835 mm.
415 mm.
795 mm. Segmented
805 mm. Segmented

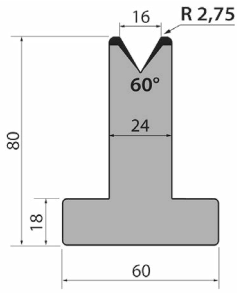

● **T80.16.60**

835 mm.
415 mm.
795 mm. Segmented
805 mm. Segmented

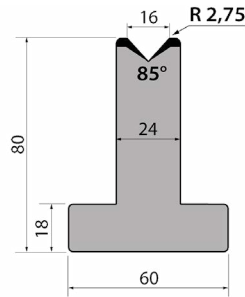

● **T80.16.85**

835 mm.
415 mm.
795 mm. Segmented
805 mm. Segmented

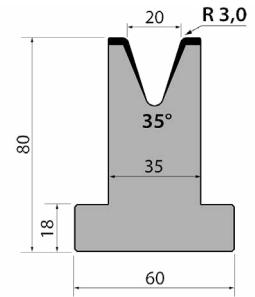

● **T80.20.35**

835 mm.
415 mm.
795 mm. Segmented
805 mm. Segmented

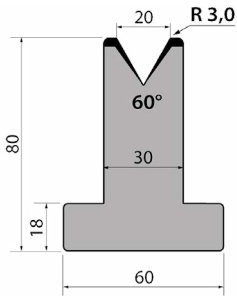

● **T80.20.60**

835 mm.
415 mm.
795 mm. Segmented
805 mm. Segmented

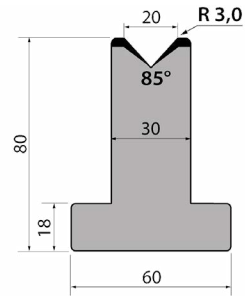

● **T80.20.85**

835 mm.
415 mm.
795 mm. Segmented
805 mm. Segmented
900 mm.

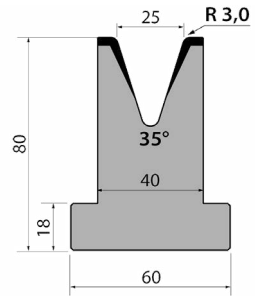

● **T80.25.35**

835 mm.
415 mm.
795 mm. Segmented
805 mm. Segmented

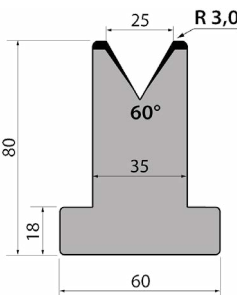

● **T80.25.60**

835 mm.
415 mm.
795 mm. Segmented
805 mm. Segmented

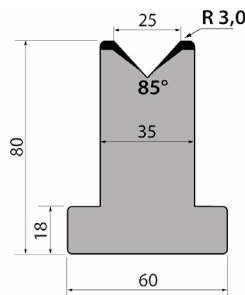

● **T80.25.85**

835 mm.
415 mm.
795 mm. Segmented
805 mm. Segmented
900 mm.

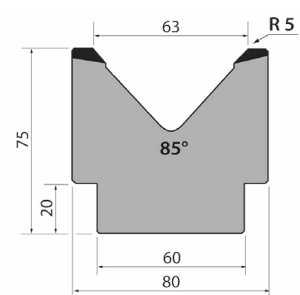

● **M75.85.63**

835 mm.
415 mm.
795 mm. Segmented
805 mm. Segmented

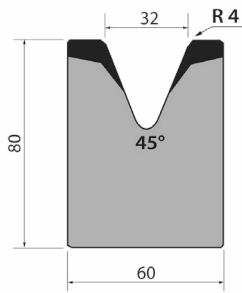

● **M80.45.32**

835 mm.
415 mm.
795 mm. Segmented
805 mm. Segmented

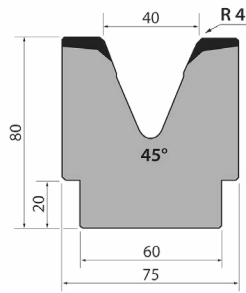

● **M80.45.40**

835 mm.
415 mm.
795 mm. Segmented
805 mm. Segmented

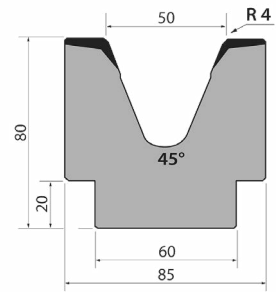

● **M80.45.50**

835 mm.
415 mm.
795 mm. Segmented
805 mm. Segmented

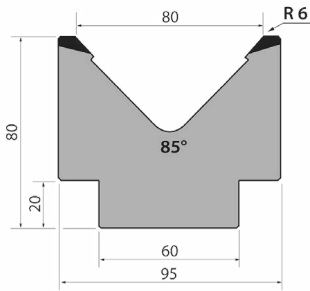

● **M80.85.80**

835 mm.
415 mm.
795 mm. Segmented
805 mm. Segmented

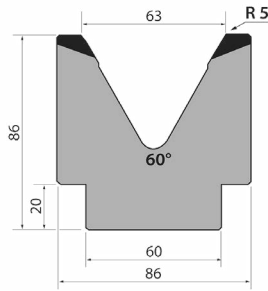

● **M86.60.63**

835 mm.
415 mm.
795 mm. Segmented
805 mm. Segmented

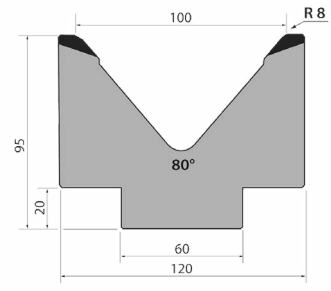

● **M95.80.100**

835 mm.
415 mm.
795 mm. Segmented
805 mm. Segmented

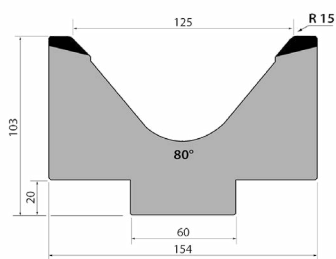

● **MK103.80.125**

835 mm.
415 mm.
795 mm. Segmented
805 mm. Segmented

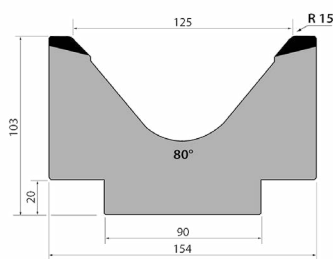

● **M103.80.125**

835 mm.
415 mm.
795 mm. Segmented
805 mm. Segmented

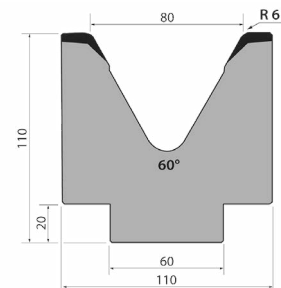

● **M110.60.80**

835 mm.
415 mm.
795 mm. Segmented
805 mm. Segmented

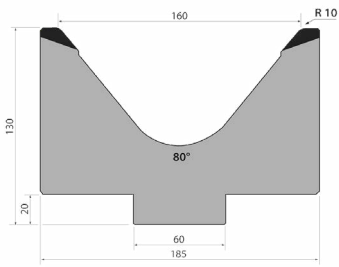

● **MK130.80.160**

835 mm.
415 mm.
795 mm. Segmented
805 mm. Segmented

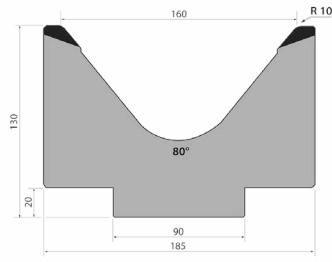

● **M130.80.160**

835 mm.
415 mm.
795 mm. Segmented
805 mm. Segmented

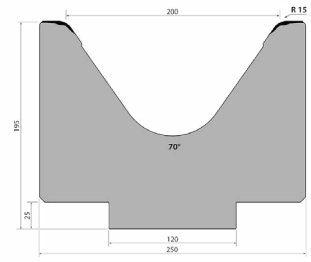

● **M195.70.200**

835 mm.
415 mm.
795 mm. Segmented
805 mm. Segmented

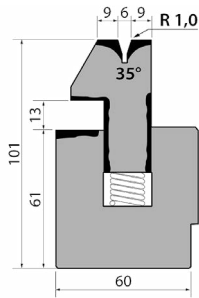

● **S101.35.06**

835 mm.
415 mm.

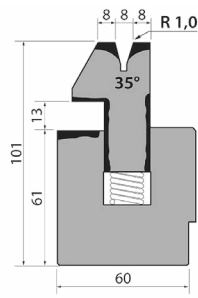

● **S101.35.08**

835 mm.
415 mm.

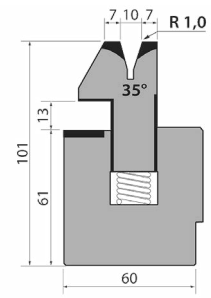

● **S101.35.10**

835 mm.
415 mm.

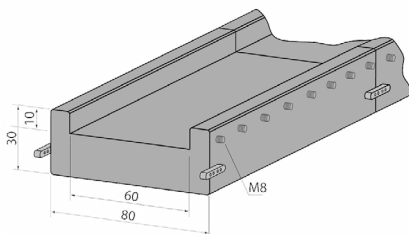

● **C1050/RS**

1050 mm.
520 mm.

MP1500CNC

- > Punch working speed: 8,3 mm/s.
- > Return speed of the punch: 120 mm/s.
- > Lowering speed of the punch: 200 mm/s.
- > Maximum punch displacement: 200 mm.
- > Inner folding length: 1250 mm.
- > Total folding length: 1500 mm.
- > Back gauge displacement: 600 mm.
- > Neck: 270 mm.



MP3003CNC

- > Punch working speed: 6,7 mm/s.
- > Return speed of the punch: 43,4 mm/s.
- > Lowering speed of the punch: 26,8 mm/s.
- > Maximum punch displacement: 160 mm.
- > Inner folding length: 2700 mm.
- > Total folding length: 3125 mm.
- > Back gauge displacement: 600 mm.
- > Neck: 320 mm.



OUR RANGE OF MACHINERY



IRON WORKERS



SECTION BENDING
MACHINES



NON-MANDREL PIPE
BENDER



HORIZONTAL PRESS
BRAKES



TWISTING/SCROLL
BENDING MACHINES



HYDRAULIC PRESS
BRAKES



HYDRAULIC SHEAR
MACHINES



GAS FORGES



IRON EMBOSSING
MACHINES



END WROUGHT IRON
MACHINES



BROACHING MACHINES



POWER HAMMERS



PRESSES FOR LOCKS

WARRANTY

Nargesa machines have 3 years warranty provided that the customer registers it in our website. Otherwise it would be only one year warranty. This one encloses any manufacturing default all along these 3 years for components. Any misuse is excluded from this condition. Labor, back and forth shipping and any eventual repair, are not included in this warranty.

Partner companies



SHIPMENT EVERYWHERE

Nargesa will arrange transport up to final destination, whenever the customers asks for so. There is also the possibility for the customer to arrange the shipment himself with his own agency.

TECHNICAL ASSISTANCE

All our customers have access to technical support quickly and efficiently.

90% of incidences are solved out on the phone, mail, Skype or videoconferencing in less than 24hours. In case of needing presencial technical assistance, we may as well send a technician to the customer's facilities.

Follow us on

PRADA NARGESA, S.L.

Ctra. De Garrigàs a Sant Miquel s/n
17476 Palau de Santa Eulalia (Girona) Spain
Tel. +34 972 568 085

www.nargesa.com

nargesa@nargesa.com



This information might undergo changes