

IRONWORKER MACHINE

MX340G

NS: 2023-1760

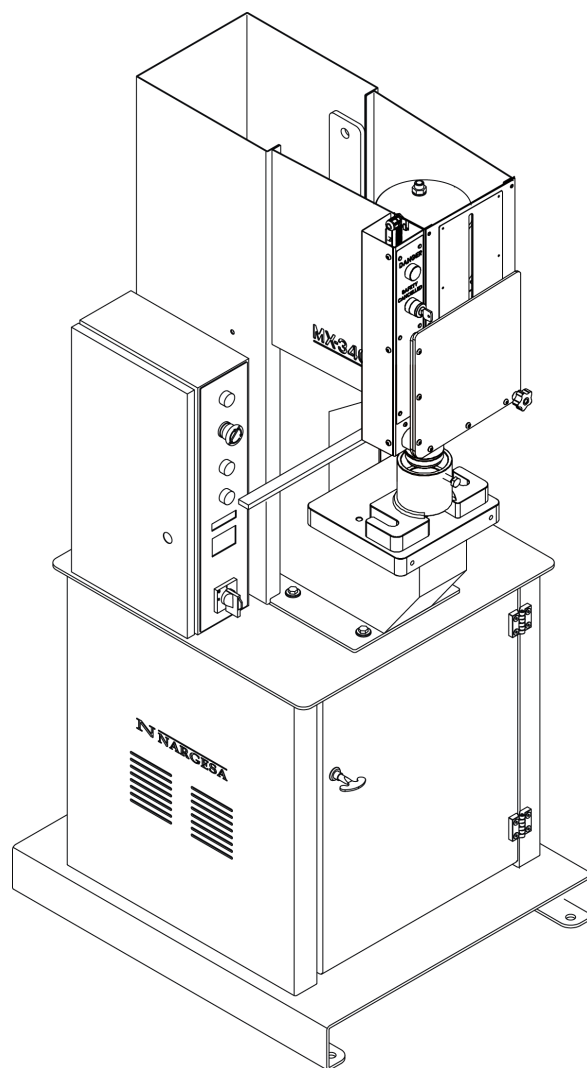

INSTRUCTIONS BOOK

PRADA NARGESA, S.L

Ctra. de Garrigàs a Sant Miquel s/n · 17476 Palau de Santa Eulàlia (Girona) SPAIN

Tel. +34 972568085 · nargesa@nargesa.com · www.nargesa.com

NARGESA CLIENTS

Prada Nargesa has more than 8.000 customers around the world. Some of our clients, those who offer service to third parties with the Nargesa machinery in their workshops, have been pleased to be part of this network that aims to connect them with possible future clients. In this way, all those people or companies that have a need for any part or tool that can be manufactured by using the Nargesa range of machinery, will be able to find a solution in their area to be able to satisfy their production requirements by hiring their services.



We have more than 8.500 customers in 150 different countries around the world

Discover its location on the interactive map on our website!

DO YOU WANT TO PARTICIPATE?

Send an email to nargesa@nargesa.com, include the following information and we will add you to this list.

We want to encourage all those who haven't participated yet in this great commercial network!

1. Company name
2. CIF/Tax Code
3. City
4. Country
5. Machine or machines

PRADA NARGESA

Prada Nargesa S.L. is a family business founded in 1970 located near Barcelona, Spain, with more than 50 years of experience in the sector of manufacturing of industrial machinery, and more than 10.000m² of facilities. Nargesa is a symbol of quality, reliability, warranty and innovation.

Our whole range of machines and accessories is manufactured entirely in Nargesa. We have a constant stock of 400 machines, and we have more than 16.800 machines sold all over the world.



OUR RANGE OF MACHINERY

Ironworker Machines

Ring Roller Bender and Pipe Bender

Non-mandrel Tube and Pipe Bender

Twisting / Scroll Bending Machines

Horizontal Press Brakes

End Wrought Iron Machines

Gas Forges

Iron Embossing Machines

Hydraulic Shear Machines

Hydraulic Press Brakes

Presses for Locks

Broaching Machines

Power Hammers

CERTIFICATES

Prada Nargesa has several certifications that backup both, the design and manufacturing processes, as well as the journey through exporting our products around the world and the quality of the manufacturing components we use for our machines. These facts turn into real advantages for our customers:



AUTHORIZED EXPORTER

- Faster customs procedures
- Reduction of tariff documentation
- Tariff preferences according to geographical location



INNOVATIVE SME

- Development in innovation, design and manufacturing technologies
- Certification and audit of efficiency in product and service
- Ability to foresee customer needs



R+D+I MANAGEMENT

- Manufacturing based on the R+D+I process
- Technological surveillance system

SUCCESS STORIES

At Prada Nargesa we believe that the testimony of our clients is our best guarantee, and that is why we like to expose some of the success stories that we have witnessed around the world:



Discover its location on the interactive map on our website!

DO YOU WANT TO PARTICIPATE?

Send an email to nargesa@nargesa.com including the following information and we will add you to our website

Company name

Testimonial name

Post in the Company

Country

Descriptive text

Photography with the machine

INDEX

1. FEATURES OF THE MACHINE	4
1.1. General dimensions	4
1.2. Description of the machine	4
1.3. Identification of the machine	5
1.4. General characteristics	6
1.5. Description of safety devices	6
2. TRANSPORT AND STORAGE	7
2.1. Transport	7
2.2. Storage conditions	7
3. MAINTENANCE	8
3.1. General maintenance	8
4. INSTALLMENT AND STARTING UP	9
4.1. Location of the machine	9
4.2. Dimensions and working site	9
4.3. Admissible outer conditions	9
4.4. Connection to power supply	10
5. OPERATION MANUAL	11
6.1. Introduction	12
6.2. Power supply of the machine	12
6.3. Activation of the machine	12
6.4. Working at manual mode	13
6.5. Working at automatic mode	13
6.6. Meter deletion	14
6.7. Desactivation of the machine	15
6.8. Unusual performance situations	15
7. WARNINGS	17
8. ACCESSORIES	18

TECHNICAL ANNEX

1. FEATURES OF THE MACHINE

Make	Nargesá
Type	Hydraulic press
Model	MX340G

1.1. General dimensions

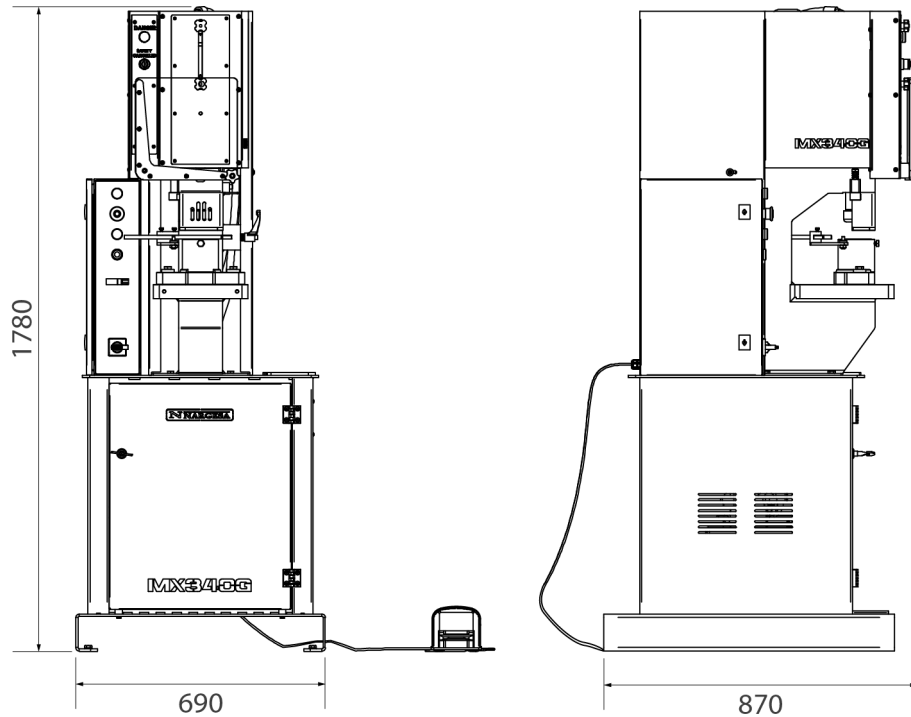

Picture 1. Outer dimensions of the MX340G

1.2. Description of the machine

MX340G, is specifically designed for punching metal pieces with different shapes depending on the kind of punch.

It may have some other uses by adapting the required accessories. It will be also usable at other services whenever the manufacturer's rules are followed. He will provide the user with all adjustable tooling for the machine.

MX340G is adapted to the current European regulations and normatives for machinery manufacturing.

1.3. Identification of the machine

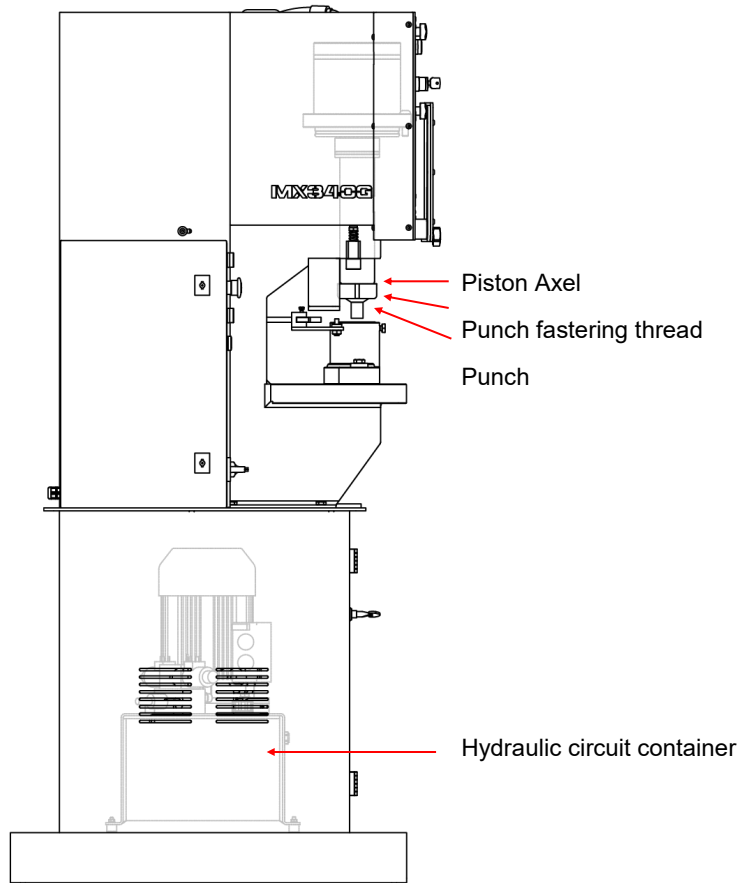
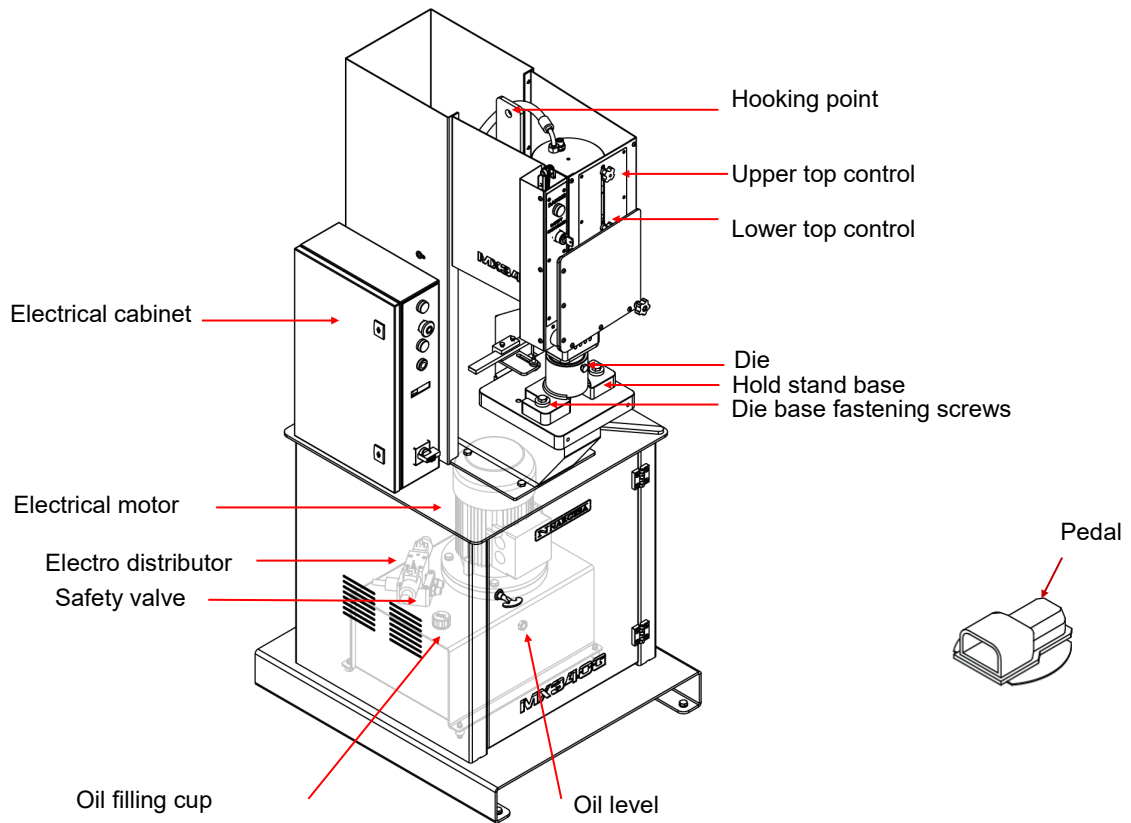



1.4. General characteristics

Engine power	2,2 Kw / 3 HP a 1460 r.p.m.
Tension	230/400V Three-Phase 230V Single-Phase
Consumption	9/5 A
Pump	7,5 l./m
Container	27 litros
Double effect piston	34 Tn
Hydraulic pressure	200 Kg/cm ² (20 MPa)
Structure material	Plaque
Total weight	615 Kg

1.5. Description of safety devices

One of the safety devices the MX340G's got is the extractor piece located in the front part of the machine to hold up the material and prevent from placing hands between the punch and the piece.

It has also got a screen to protect the user from any projections coming from the working piece. This screen has a safety system to avoid the punch from descending if the screen is up. It would only work if the user turns the key C to cancel this safety command, then it would be possible to work along with the hazard light D.

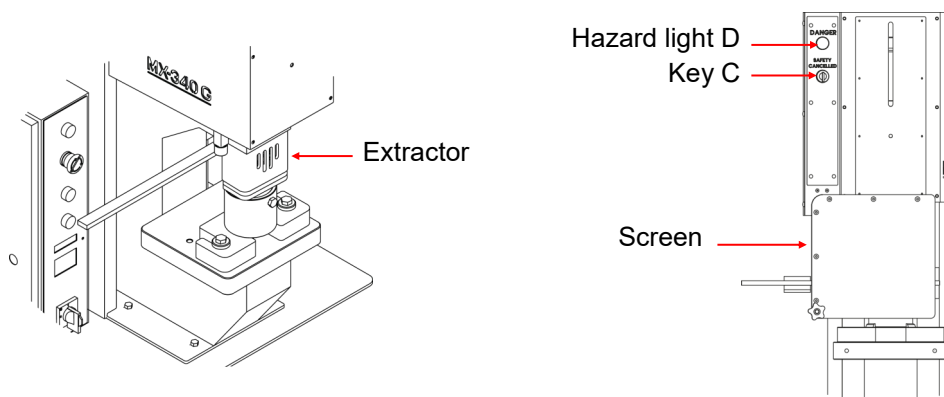

Picture 3. Protection devices of the machine

2. TRANSPORT AND STORAGE

2.1. Transport

The transport without lifting will be carried out by a transpalet, with elevation will be made by a crane, using the hooking spot marked below. although it must never be lifted more than 300mm, to prevent from a turnover.

Handrails on the base will only do for the transportation. Once the machine is placed on its final site it must be left so it can settle down on the ground.

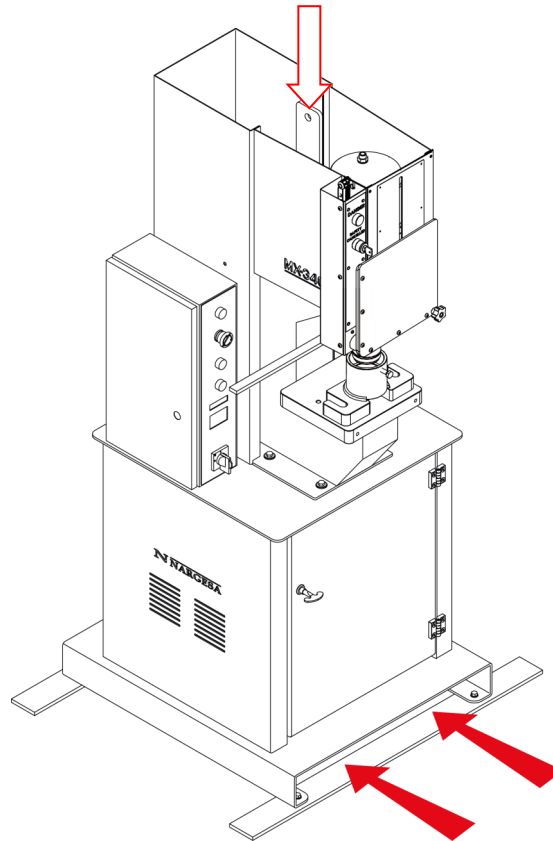

Picture 4. Transport of the machine

2.2. Storage conditions

The machine ought to be stored in a place that meets the following requirements:

- * Humidity between 30% and 95% without condensation.
- * Temperature from -25 to 55°C or 75°C for a length of time no longer that 24 hours (keep in mind that these temperatures are just for storage conditions).
- * It is advisable not to stack machines or heavy objets on them.
- * Do not dismantle it for storage.

3. MAINTENANCE

3.1. General maintenance

- Oil level container must be checked up every 500 hours of use.

In the frontal part of the container we can find the oil level cap. In case of lack of oil, please fill up the container until the oil cap shows 3/4 parts full. *Picture 5*

- Replace hydraulic oil of the container every 2000 hours of work or every 3 years.

Type: CEPESA HIDRAULICO HM 68

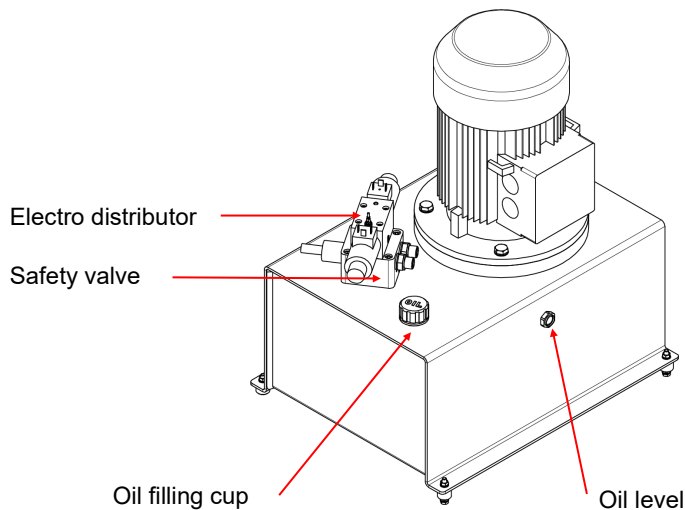

Picture 5. Identification of the Components of the hydraulic container

WARNING

Stop the machine and press the emergency stop to carry out the oil change. *Pictures 6 and 7*

Once the oil has been changed, start up the machine and press the pedal intermitently raising up the pressure time gradually until the circuit is full. You'll see the machine running its normal route.

- Grease punches periodically according to the use received.
- If t is daily and steadily used, grease it everyday.
- If it is daily used but just on and off, then grease ut every week.
- If the use is just sporadic, then grease it once a month.

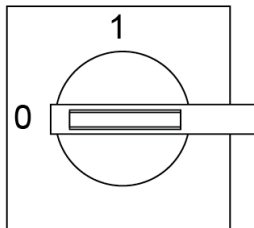

Picture 6. Stop The Machine

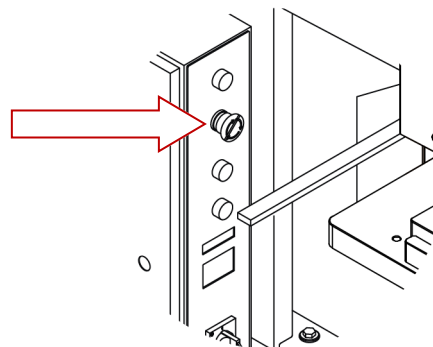

Picture 7. Press the emergency stop

4. INSTALLMENT AND STARTING UP

4.1. Location of the machine

Try to place the machine at first properly so it doesn't have to be moved, if not then follow the steps described in the *transport section (n°2)*. The surface to put the machine on must be flat and leveled to avoid vibrations and movements while it is performing. It is possible to get the machine fixed by using hinges, since it is provided with a lower base or stand with 4 perforations as shown in the *picture 8*.

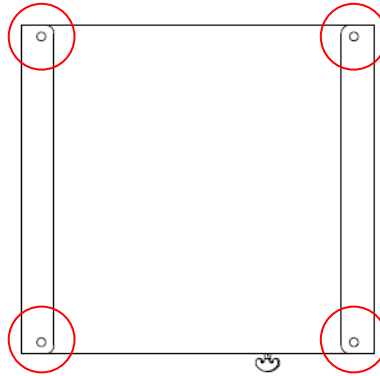

Picture 8. Description of the clamping holes to fix the machine

4.2. Dimensions and working site

When placing the machine it is necessary to take into account its size and dimensions, the operative working area and the different lengths of the parts to be worked.

The machine will be only used by one worker at the time, and he will be located at the front part of the machine, never on the side because he has to control the rest of the machine and the main protections are designed for the frontal use of the machine.

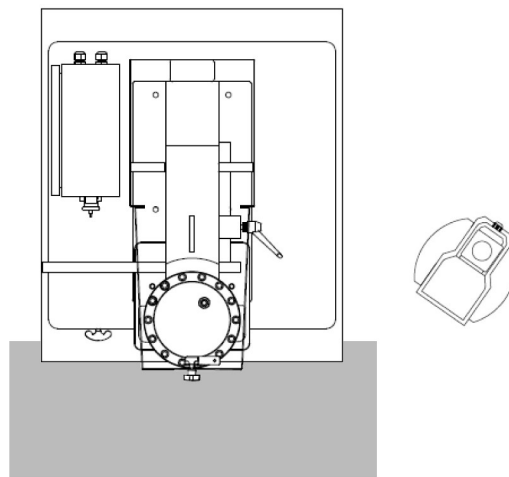

Picture 9. Operative's working area

4.3. Admissible outer conditions

- Temperature between +5°C and +40°C without overpassing an average temperature of +35°C during 24 hours
- Humidity between 30% and 90% without water condensation.

4.4 Connection to power supply

IMPORTANT

This must be connected to a power supply with ground wire.

MX340G, is equipped with an 230V/400V three phased engine, 2.2 Kw star connected to be connected to a 400v power supply. It could be connected to only one power supply in the power source indicated. If the line tension is not the one indicated then it is necessary to change the motor bobbins connection and the transformer as it is indicated in the pictures.

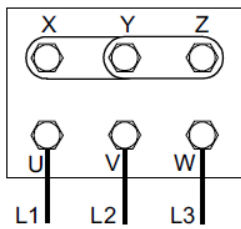

Picture 10. Star Picture for tension 400V

(preset)

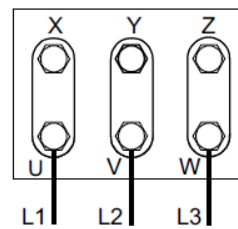

Picture 11. Triangle picture for tension 230V

In case of change of voltage from 400V to 230V, switch terminal 6 from 400V to 230V.

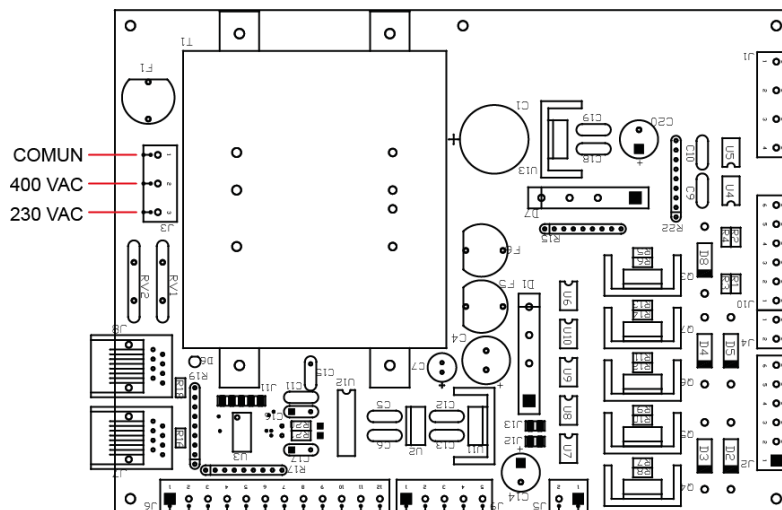

Picture 12. Location of Terminal 6 on the electric plate

5. OPERATION MANUAL

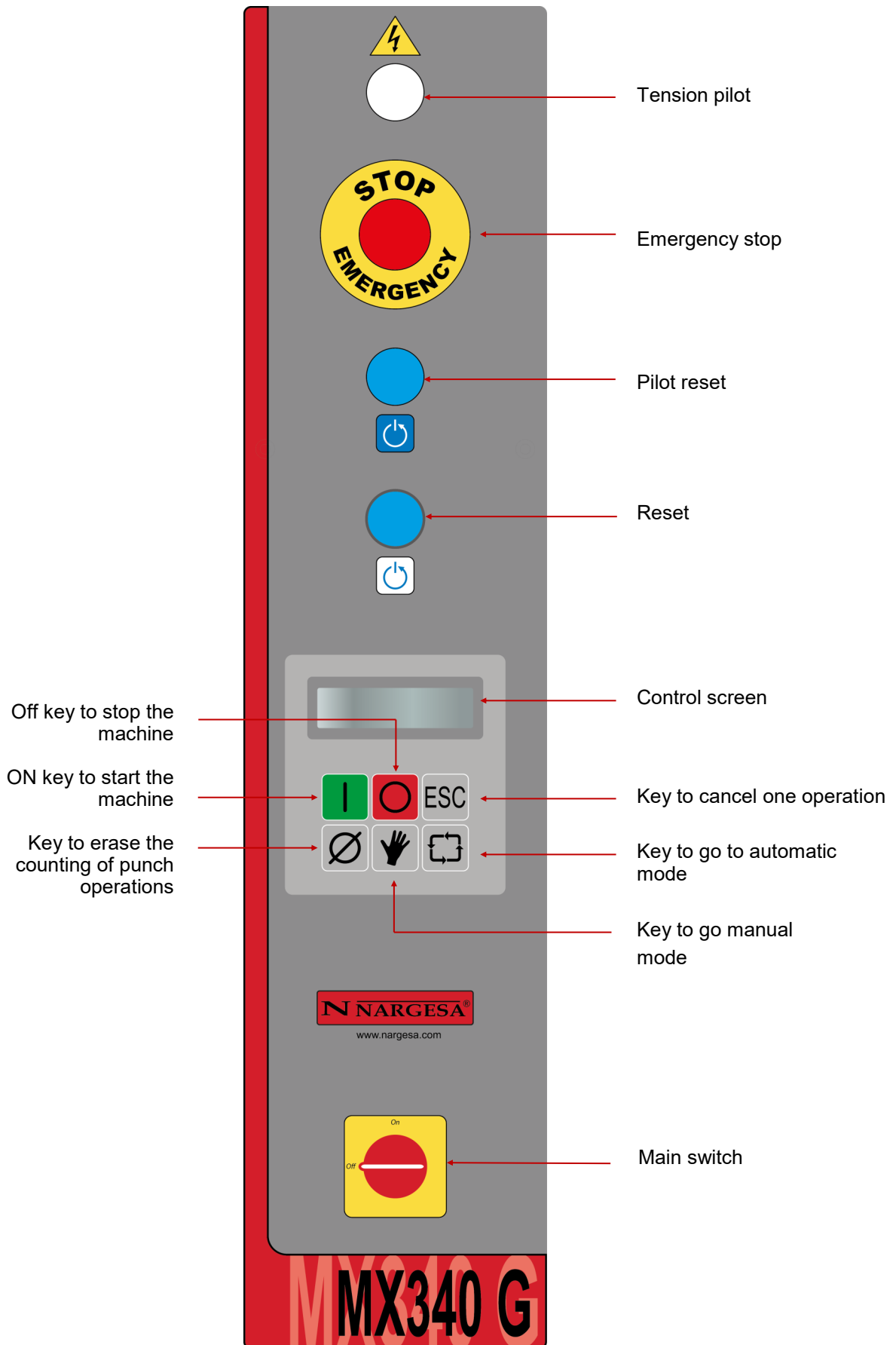

Picture 13. Control Panel

5.1. Introduction

This manual is designed to be an useful tooling for the MX340G user since it has important information about the usage and specifications of the machine. Therefore it is important to follow step by step all the points detailed in this manual so to get to achieve a better understanding of the performance of the machine.

5.2. Power supply of the machine

In order to feed up the machine, just set the **Start switch** to the CONNECTED position. Then, a label as the one below will show up on the screen.



Picture 14. Message system reset

Machine pilots for voltage and reset the system will illuminate. We perform the Reset by pressing the button on the control panel. The alarm lamp will turn off, if not so, make sure that there is no abnormal situation.

The machine is at the moment in a StandBy mode, where the machine is activated but it is in rest position awaiting any order.

5.3. Activation of the machine

Once the machine is initialized and in StanBy mode, you may activate it to work with it following the steps we describe below:

In order to do it correctly , please, press the **key ON**. Then you'll spot a label on the LCD screen reading what is said below:

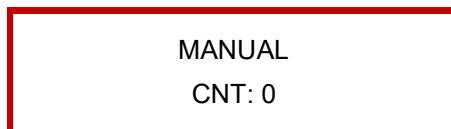

Picture 15. Label indicating the machine is activated

The information represented in the previous Picture shows the current operation mode, in the display (Manual or Automatic).In the lower line there is the meter of the machine which is increased every time the pedal is pressed.

5.4. Working at manual mode

In this mode, follow the steps described next: Press the pedal to make the punching operation. Then you will see on the LCD screen that the meter of the machine has been increased in one unit.

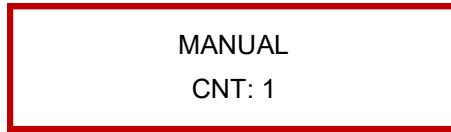

Picture 16. Information of the Manual Punching operation

In *picture 16*, you can see how the meter marks 1 punching operation now. Once that punching operation has been completed, you may get your foot off the pedal.

You must keep in mind that this mode of performance permits the piston rod descend bit by bit as you are pressing the pedal longer or not. When the lower route end is reached or when you raise your foot off the pedal, the rod movement stops.

According to this way of performance, you may adjust the Lower route end to graduate the the going down of the rod while you press the pedal and so you will be able to see how the machine keeps on descending until the aforesaid mentioned route end is reached.

Finally, it is important to remind that in this mode of performance the rod of the machine never goes in ascending direction, so in case you need it to go up, you should proceed as detailed in the following section.

5.5. Working at automatic mode

In order to go from MANUAL working mode to AUTOMATIC working mode, just press the **AUTOMATIC key**. In doing so, the machine will ask you a confirmation and we press the **AUTO key** again. Then the rod will activate going up. Such movement won't stop until the machine has reached the Upper End route. Except for that the AUTOMATIC mode is quite similar to the one described in the *section 5.4*.

However, we will point out below some of the differences we find:

Press the pedal to make the punching operation. Then you will see the meter of the machine increased in one unit.

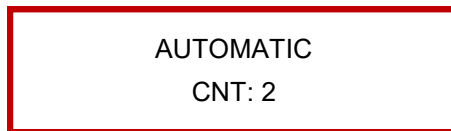

Picture 17. Information of the Automatic punching operation

In *picture 17*, you can see how the meter has increased again when pressing the pedal and now it is indicating a 2. Once this operation has been finished, you may leave your foot off the pedal. Nevertheless in this working mode, unlike in the other one, the piston rod will come back again to the rest position when it will start up the going up movement until the lower end route is activated.

You should keep in mind that this working mode will also allow the rod to descend bit by bit to adjust the going down by the positioning of the lower end route. Whenever you keep the pedal pressed the rod will make a descending movement that will be only interrupted when the route end is activated. When you raise the foot off the pedal the rod will invert the movement and will start up ascending.

5.6. Meter deletion

As you have read in the previous sections, MX340G has got a punching meter that increases everytime you press the pedal. This fact could be useful in case you need to count the punching operations required for either a specific piece or the operations a third user has carried out with your machine.

Obviously, this meter can be deleted. In order to do it right, and supposing there is a label like this one on the LCD screen, for instance, You have carried out 150 punching operations, keep on the following indications.

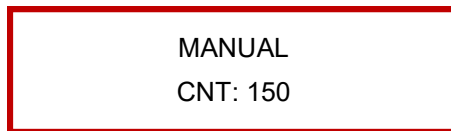

Picture 18. Information about the number of operations made.

It is important that the meter could be erased always and just when you find the machine ready to start working but without doing any operation (in StandBy mode it is not possible), so it is possible in Automatic or Manual mode.

Just press the **COUNTER key**. Then the message in the screen will change into this other one.

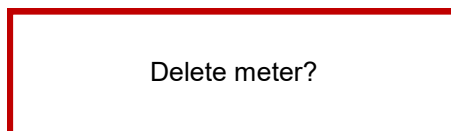

Picture 19. Message of information about the meter deletion.

It is obvious that if you press **ESC key**, the meter will not be affected and it will go back to the previous screen. On the other hand, in case you wish to delete the meter when you see the question made by the previous screen, just press **COUNTER key** again. the new message will show up as follows on the screen.



Figura 20. Information of the meter deletion

5.7. Desactivation of the machine

Any time that the activated machine is in rest position, you can deactivate it. If you wish so, please press the key OFF and the machine will deactivate and will go to the StandBy mode (See section 5.2).

5.8. Unusual performance situations

An unusual performance situations may happen any time, it implicates to stop any operation that is being carried out at the moment.

Unusual situations are divided into two big groups, Emergency situations and Error situations. Causes that lead to both groups are specified below.

Situations of emergency:

Activation of the Emergency Stop.



Figura 21. Information about the Emergency Stop

Error Situations:

Error in the Upper Route End of the machine.



Figura 22. Information about the Error in the Upper route end

Error in the Lower route End of the MX340G.

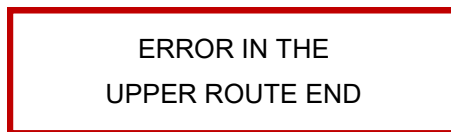

Figura 23. Information about error in the Lower Route End

So, when we face one the aforementioned situations, the machine goes to such a estate that it aborts any operation that is being performed at the moment, then a label will show up indicating the sort of unusual situation sthat has occurred.

For safety reasons, it is not permitted a new activation of the MX340G until the unusual situation has been solved ou. In case of Emerergency Situations, it can be solved out rearming the emergency Stop button. Once it has been done the machine will restart and it will go into a StandBy mode (please see *section 5.3* for a further activation of the MX340G).

In case an Error situation occurs, with the intention of preventing from bigger damages or hazardous situa-tions for the users, the MX340G will remain blocked and the corresponding label will come out on the screen. In this case the machine can be unblocked by unplugging it from the power supply and plugging it again afterwards. Anyways in case any of these situations occurs, please contact our Technical Service so the problem can be solved out as soon as possible.

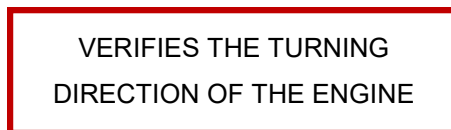
6. WARNINGS

- Do not handle any component while the machine is performing.
- Do not use the machine for any other purpose but the ones described in this manual.
- Wear safety gloves when handling all components of the machine and while performing the punching operations.
- Wear safety glasses and safety footwear according to the current European regulations.
- Do not work without the protection devices provided along with the machine.
- Keep a safety distance between the machine and the operative while the machine is performing.
- Do not use any other tooling but the ones provided by NARGESA.
- All tooling that can be fitted to the machine must be fixed to the base and also to the piston.
- In case of an accident due to the negligence of the operative for not following the usage and safety rules described in this manual, NARGESA S.L will not take any responsibility.

WARNING!

Never place pieces that don't stand both lateral sides of the EXTRACTOR

Never punch extremely narrow or flexible parts since they might bend in towards the extractor.

- Do not punch pieces that cannot symmetrically stand on the extractor.
- Do not punch if the piece is not leaning on both sides of the extractor

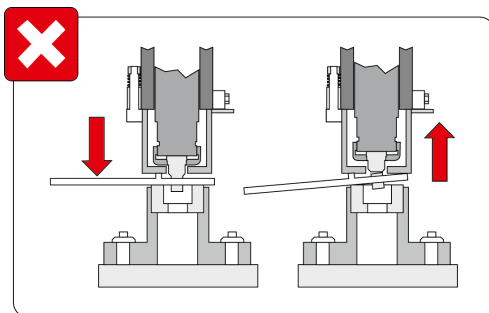

The punch breaks down when going back.

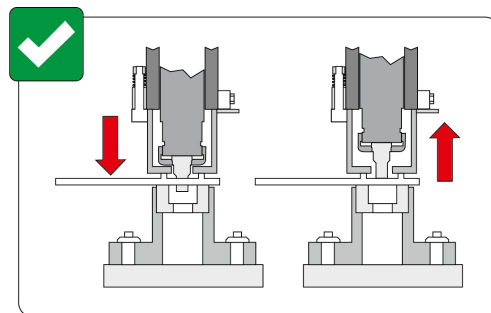

Correct extraction

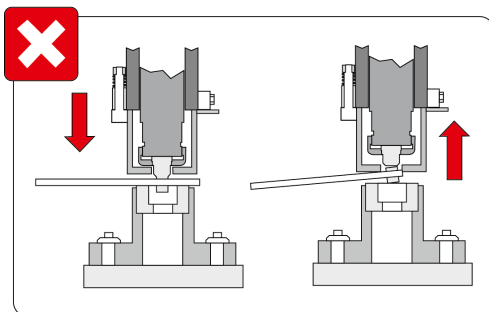

The punch breaks down when going back.

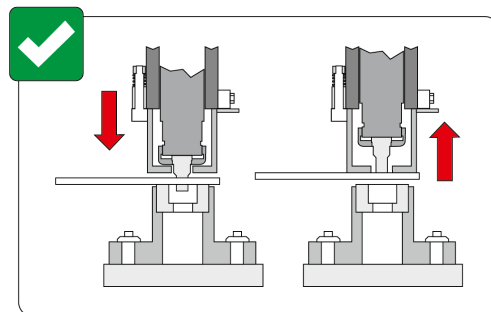

Correct extraction

Never punch a metal sheet thicker than the punch diameter

7. ACCESSORIES

All Nargesa Hydraulic Punching Machines are equipped with the punching tool that include the fitting nut for punches and the base holder for dies. The rest of accesories are optional, which means each customer equips his machine as desired.

► Fitting nuts for punches MX340

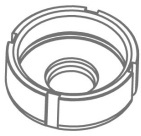

TAP



ATAP

Refference	Type	Fitting nuts for punches
120-02-01-00011	TAP28	Fitting nuts for punches N28 <i>Standard</i>
140-02-01-00019	TAP40	Fitting nuts for punches N40
140-02-01-00020	TAP50	Fitting nuts for punches N50
140-02-01-00021	TAP60	Fitting nuts for punches N60
125-02-01-00002	ATAP	Fitting part for TAP60

► Fitting parts for dies MX340



CAB

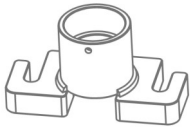

PORTABASES

Refference	Type	Fitting for dies
120-02-01-00012	N46	Fitting for dies N46 <i>Standard</i>
140-02-01-00024	N60	Fitting for dies N60
140-02-01-00025	N78	Fitting for dies N78
140-02-01-00037	N100	Base holder for dies N100
140-02-01-00038	N125	Base holder for dies N125

► Standard round punches MX340

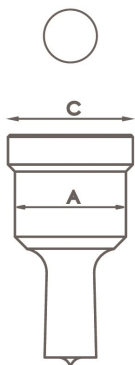

Type	Available sizes in mm Ø	A	B	C
N28	3/3'5/4/4'5/5/5'5/6/6'5/7/7'5/8/8'5 9mm up to 28mm from 0'5 in 0'5mm	28 mm	58 mm	31,5 mm
N40	29/30/31/32/33/34/35/36/37/38/39/40mm	40 mm	64 mm	43,5 mm
N50	41/42/43/44/45/46/47/48/49/50mm	50 mm	58 mm	54 mm
N60	52/54/56/58/60mm	60 mm	58 mm	64 mm
N75	62/64/66/68/70/72/74mm	75 mm	58 mm	79 mm
N100	76/78/80/82/84/86/88/90/92/94/96/98/100mm	100 mm	58 mm	104 mm

For different sizes, please ask the manufacturer.

► Standard square punches MX340

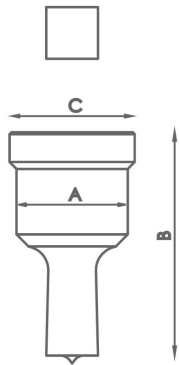

Type	Available sizes in mm Ø	A	B	C
N28	4/5/6/7/8/9/10/11/12/13/14/15/16/17/18/19/20mm	28 mm	58 mm	31,5 mm
N40	21/22/24/26/28mm	40 mm	64 mm	43,5 mm
N50	31/33/35mm	50 mm	58 mm	54 mm
N75	40/44/48/53mm	75 mm	58 mm	79 mm
N100	58/64/70mm	100 mm	58 mm	104 mm

For different sizes, please ask the manufacturer.

► Standard rectangular punches MX340

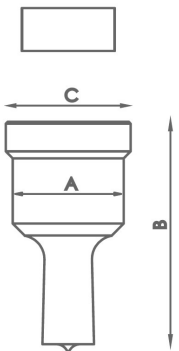

Type	Available sizes in mm Ø	A	B	C
N28	7x10/7x15/9x13/9x19/11x17/11x23 13x19/15x21mm	28 mm	58 mm	31,5 mm
N40	13x25/15x27/17x25/19x30/20x34mm	40 mm	64 mm	43,5 mm
N50	25x43mm	50 mm	58 mm	54 mm
N75	25x70mm	75 mm	58 mm	79 mm
N100	25x96mm	100 mm	58 mm	104 mm

For different sizes, please ask the manufacturer.

► Standard oval punches MX340

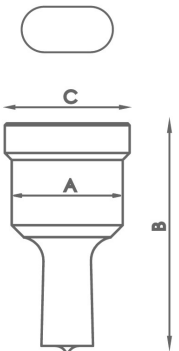

Type	Available sizes in mm Ø	A	B	C
N28	7x10/7x15/7x20/9x13/9x19/11x17/11x23/13x18 13x22/13x27/15x20/15x24/15x27/17x22/17x26 19x26/21x27mm	28 mm	58 mm	31,5 mm
N40	13x31/15x31/17x31/17x40/19x31 19x40/21x31/21x40mm	40 mm	64 mm	43,5 mm
N50	25x45/25x50mm	50 mm	58 mm	54 mm
N75	27x63/27x75mm	75 mm	58 mm	79 mm
N100	30x87/30x100mm	100 mm	58 mm	104 mm

For different sizes, please ask the manufacturer.

► Standard round dies MX340

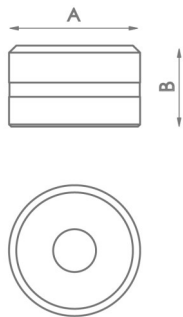

Type	Available sizes in mm	A	B
N46	3/3,5/4/4,5/5/5,5/6/6,5/7/7,5/8/8,5 9mm up to 28mm from 0,5 in 0,5mm	46 mm	28,5 mm
N60	29/30/31/32/33/34/35/36/37/38/39/40mm	60 mm	32 mm
N78	41/42/43/44/45/46/47/48/49/50mm	78 mm	28,5 mm
N100	52/54/56/58/60/62/64/66/68/70/72/74mm	100 mm	28,5 mm
N125	76/78/80/82/84/86/88/90/92/94/96/98/100mm	125 mm	28,5 mm

For different sizes, please ask the manufacturers.

► Standard square dies MX340

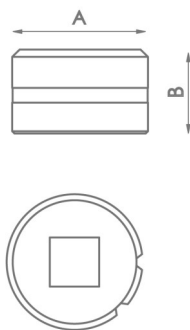

Type	Available sizes in mm	A	B
N46	4/5/6/7/8/9/10/11/12/13/14/15/16/17/18/19/20mm	46 mm	28,5 mm
N60	21/22/24/26/28mm	60 mm	32 mm
N78	31/33/35mm	78 mm	28,5 mm
N100	40/44/48/53mm	100 mm	28,5 mm
N125	58/64/70mm	125 mm	28,5 mm

For different sizes, please ask the manufacturers.

► Standard rectangular dies MX340

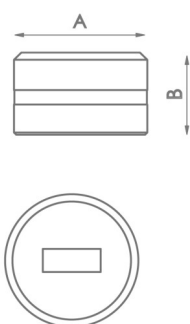

Type	Available sizes in mm	A	B
N46	7x10/7x15/9x13/9x19/11x17/11x23/13x19/13x25/ 15x21mm	46 mm	28,5 mm
N60	15x27/17x25/19x30/20x34mm	60 mm	32 mm
N78	25x43mm	78 mm	28,5 mm
N100	25x70mm	100 mm	28,5 mm
N125	25x96mm	125 mm	28,5 mm

For different sizes, please ask the manufacturers.

► **Oval dies MX340**

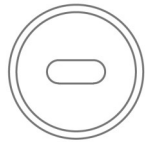
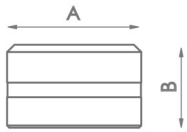

Type	Available sizes in mm	A	B
N46	7x10/7x15/7x20/9x13/9x19/11x17/11x23/13x18/13x22/13x27 15x20/15x24/15x27/17x22/17x26/19x26/21x27mm	46 mm	28,5 mm
N60	13x31/15x31/17x31/17x40/19x31/19x40/21x31/21x40mm	60 mm	32 mm
N78	25x45/25x50mm	78 mm	28,5 mm
N100	27x63/27x75mm	100 mm	28,5 mm
N125	30x87/30x100mm	125 mm	28,5 mm

For different sizes, please ask the manufacturers.

► **Tube notching tooling MX340**

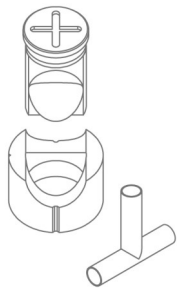

Reference	Available sizes in mm	Required fitting	
MAN28	Tube from 16 to 28mm	TAP 28	CAB 46
MAN40	Tube from 28,5 to 40mm	TAP 40	CAB 60
MAN50	Tube from 40,5 to 50mm	TAP 50	CAB 78
MAN60	Tube from 50,5 to 60mm	TAP 60	

For different sizes, please ask the manufacturers.

► **Corner rounding tooling MX340**



Reference	Available sizes in mm	Required fitting	
MRE28	Radius from 3 to 15mm	TAP 28	CAB 46
MRE40	Radius from 16 to 26mm	TAP 40	CAB 60
MRE50	Radius from 26,5 to 32mm	TAP 50	CAB 78

For different sizes, please ask the manufacturers.

► Flat bar round end tooling R1

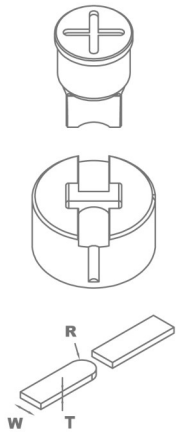

Reference	Model	Width size	Required fitting
MOR1-35A	A	From 20 to 35mm	TAP28 / TAP40
MOR1-35B	B	From 20 to 35mm	TAP28 / TAP40
MOR1-35C	C	From 20 to 35mm	TAP28 / TAP40
MOR1-35D	D	From 20 to 35mm	TAP28 / TAP40
MOR1-50A	A	From 40 to 50mm	TAP50 / TAP60 with ATAP
MOR1-50B	B	From 40 to 50mm	TAP50 / TAP60 with ATAP
MOR1-50C	C	From 40 to 50mm	TAP50 / TAP60 with ATAP
MOR1-50D	D	From 40 to 50mm	TAP50 / TAP60 with ATAP

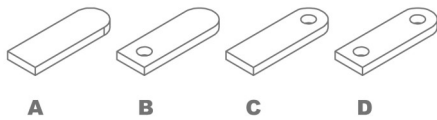

For different sizes, please ask the manufacturer.

When placing order it must be specified the REFFERENCE, MODEL, R (radius), W (flat bar width), T (flat bar thickness)

In models B, C and D specify diemeter of the hole.

The ear shaped legth is always adjustable.

Production capacity: 450 to 600 parts per hour.

► Flat bar round end tooling R2

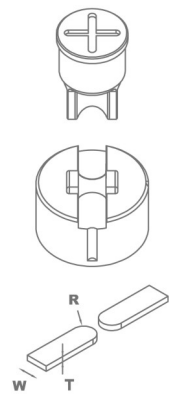

Reference	Model	Width size	Required fitting
MOR2-35A	A	From 20 to 35mm	TAP28 / TAP40
MOR2-35B	B	From 20 to 35mm	TAP28 / TAP40
MOR2-35C	C	From 20 to 35mm	TAP28 / TAP40
MOR2-50A	A	From 40 to 50mm	TAP50 / TAP60 with ATAP
MOR2-50B	B	From 40 to 50mm	TAP50 / TAP60 with ATAP
MOR2-50C	C	From 40 to 50mm	TAP50 / TAP60 with ATAP

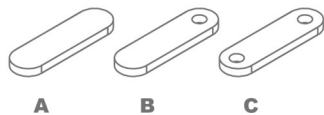

For different sizes, please ask the manufacturer.

When placing order it must be specified the REFFERENCE, MODEL, R (radius), W (flat bar width), T (flat bar thickness)

In models B and C specify hole diameter.

The ear shaped legth is always adjustable.

Production capacity: 450 to 600 parts per hour.

► Angle cutting tooling. MX340

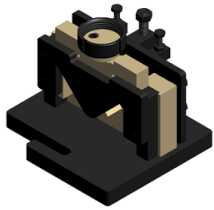

Reference: 140-02-01-00001
Angle cutting tooling, from 90° up to 45°.

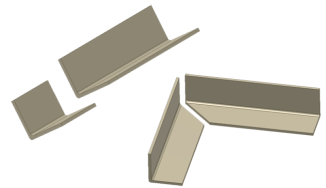

Units per machine	Max. Capacity for straight cut	Max. Cutting capacity for miter	Weight
1	60x60mm	50x50mm	32 Kg

► Flat bar cutting tooling. MX340

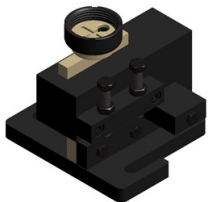

Reference: 140-02-01-00002
Tooling for cutting sheet or flat bars from 0.8mm up to 10mm thickness.

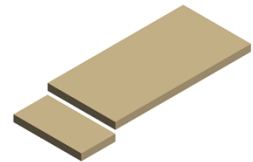

Units per machine	Max. Cutting capacity	Weight
1	100x10mm	28 Kg

► Folding tooling 170mm. MX340



Reference: 140-02-01-00004
Tooling for folding sheet and flat bar up to 170mm. 88° punch. Dies with V for 56mm and V for 26m.

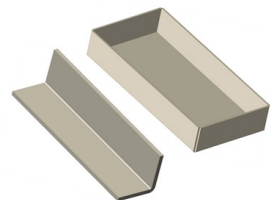

Units per machine	Max folding length	Max folding thickness	Weight
1	170mm	8 to 12mm	12 Kg

► Stripping tooling to 90° adjustable 100x100 MX340

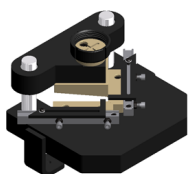

Reference: 140-02-01-00005
Stripping tooling for angle etc. Adjustable up to 100x100mm to 90° fijos.

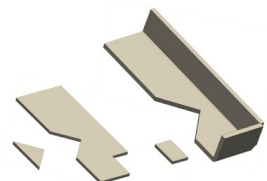

Units per machine	Max. Cutting capacity	Weight
1	100x100x4	21 Kg

▶ Arrow tooling for metal sheet MX340



Reference: 140-02-01-00006
 Tooling for punching metal sheet in arrow shapes for fences.

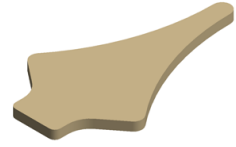

Units per machine	Max. Sheet Thickness	Weight
1	3mm	21 Kg

▶ Arrow tooling for pipes MX340

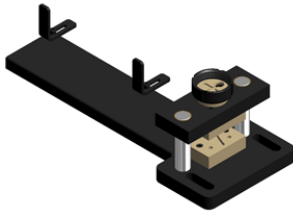

Reference: 140-02-01-00007
 Tooling to flatten and cut arrow shaped pipes end. Suitable for different diameters.

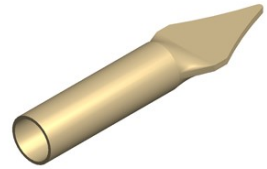

Units per machine	Pipe max. Diameter	Min. Pipe diameter	Weight
1	30x2mm	10x2mm	19 Kg

▶ Ventilation grip tooling. MX340

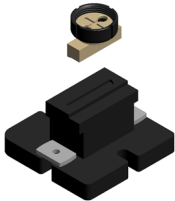

Reference: 140-02-01-00010
 Tooling to make ventilation grips in metal sheet. Adjustable amount of punchings. They are to made one by one.

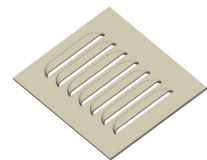

Units per machine	Punchings sizes	Max. thickness	Weight
1	100x20mm	2mm	20Kg

▶ Angle & U profile punching tooling MX340

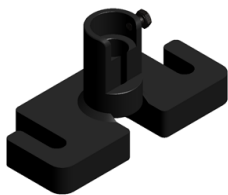

Reference: 140-02-01-00031
 Base holder for angle punching. Suitable for punches and dies of different diameters, exchangeables.



Units per machine	Max. Hole diameter	Min. Hole diameter	Weight
1	28mm	2mm	7 Kg

▶ Round bar cutting tooling. MX340

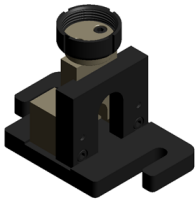

Reference: 140-02-01-00035
Tooling for cutting round bar from 3mm up to 35mm.

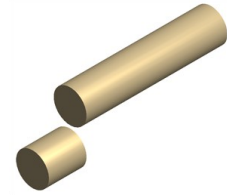

Units per machine	Max. Cutting diameter	Min. Cutting diameter	Weight
1	35mm	3mm	15 Kg

▶ Locks punch and die MX340



Reference: 140-02-01-00036
Set for making the lock hole in metal sheet.
Necessary complements: CAB60 and TAP40



Parts per set	Max. Thickness	Weight
2	6mm	1 Kg

▶ Flattening tooling MX340

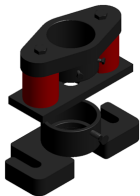

Reference: 140-02-01-00039
It's an extractor which acts as the flat bar holder at the punching time to prevent the flat bar from deformation while being punched.

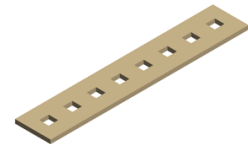

Parts per tooling	Flat Bar Max Thickness	Weight
3	15mm	15 Kg

▶ Fence post end tooling MX340

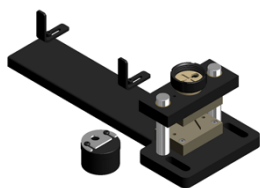

Reference: 140-02-01-00040
Tooling to flatten and punch the pipe for fences. It admits different pipe diameters. Exchangeable hole size.

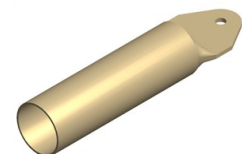

Parts per tooling	Max. Pipe diameter	Min. Pipe diameter	Hole diameter	Weight
2	50mm	10mm	Intercambiable	23 Kg

Technical annex

Hydraulic press MX340G

All parts

Electric map · THREEPHASE MACHINE



Electric map · SINGLEPHASE MACHINE

Hydraulic map

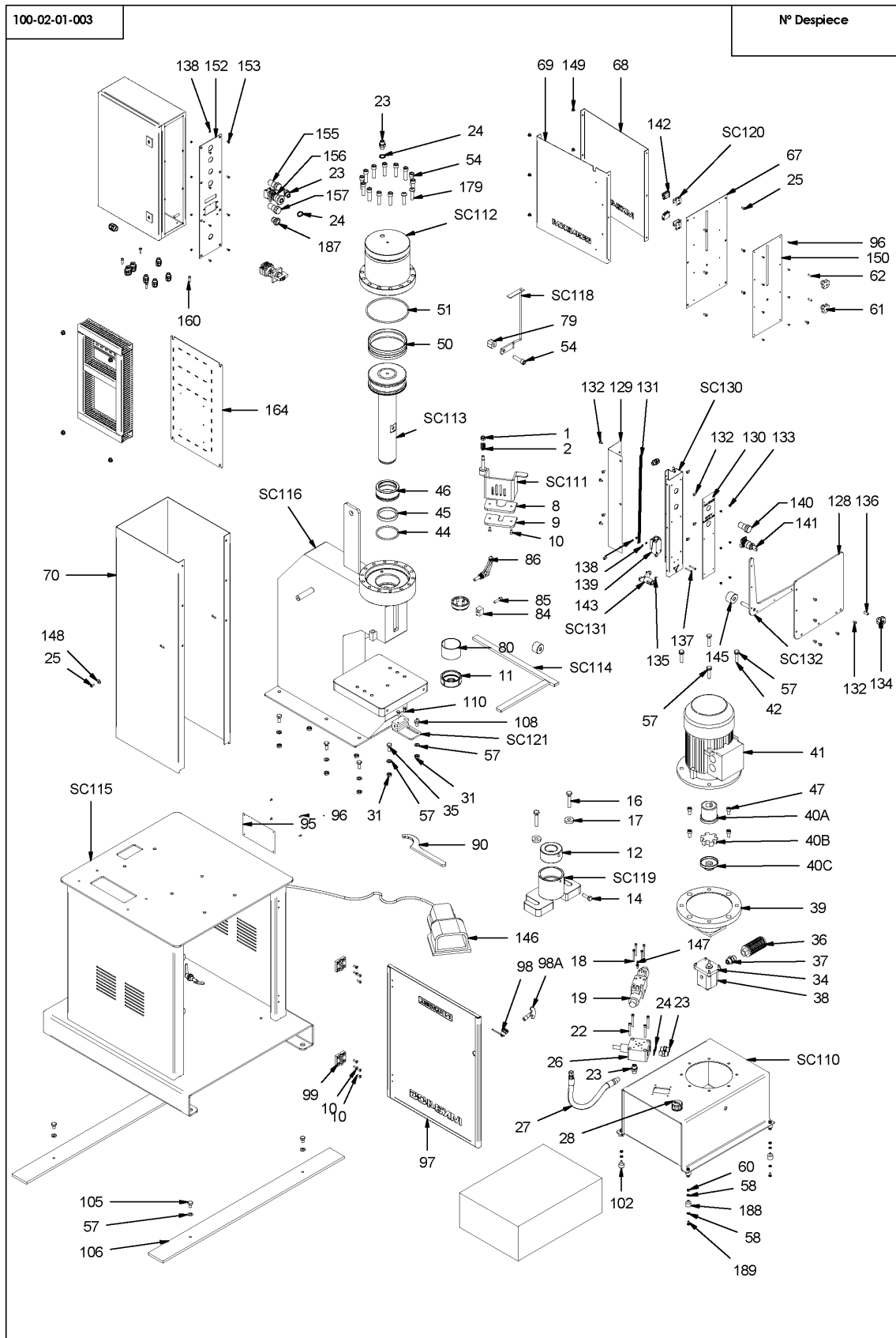



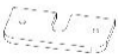

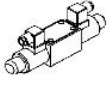





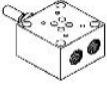

A1. All parts







Este plano es propiedad de Prada Nargesta S.L. No podrá ser reproducido, comunicado a terceros o utilizado para otro fin que no sea el acordado sin su permiso escrito.













Nº ORDEN	DIBUJO	Nº PIEZA	CANTIDAD	DESCRIPCION
1		020-DIN985-M10	1	TUERCA AUTOBLOCANTE DIN 985 M10
2		031-MUC-00001	1	MUELLE Ø13xØ18xØ2.5x23.5
8		120-02-01-00008	1	CHAPA EXTRACTORA DE 37
9		120-02-01-00009	1	CHAPA EXTRACTORA DE 18
10		020-DIN7991-M6X16	2	TORNILLO ALLEN DIN 7991 M6X16
11		120-02-01-00011	1	TUERCA ACOPLAMIENTO PUNZON de Ø28
12		120-02-01-00012	1	ADAPTADOR BASE DE CORTE Ø46 CAB3-N46
14		020-DIN933-M10X35	1	TORNILLO HEXAGONAL DIN 933 M10X35
16		020-DIN933-M12X60	2	TORNILLO HEXAGONAL DIN 933 M12X60
17		120-02-01-00017	2	ARANDELA Ø35XØ13X8
18		020-DIN912-M5X50	4	TORNILLO ALLEN DIN 912 M5x50
19		040-ELV-00005	1	ELECTROVALVULA DOBLE 5EVP3D1C02D24-NAG3
22		020-DIN912-M6X50	4	TORNILLO ALLEN DIN 912 M6X50
23		040-RMM-00003	5	RACOR MACHO MACHO 3/8"

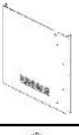



HYDRAULIC PRESS MX340G

Nº ORDEN	DIBUJO	Nº PIEZA	CANTIDAD	DESCRIPCION
24		040-JMG-00004	6	JUNTA METAL GOMA 3/8"
25		020-ISO7380-M6X12	9	TORNILLO ALLEN CABEZA REDONDA ISO 7380 M6X12
26		040-VLP-00002	1	VALVULA LIMITADORA DE PRESION
27		040-MF-00007	1	Manguera Hidraulica macho - hembra con tuerca giratoria 3/8" Gas long:450mm
28		040-TLL-00003	1	TAPON DE LLENADO 1/2"
29		040-NA-00001	1	NIVEL DE ACEITE 3/8"
31		020-DIN934-M10	7	TUERCA DIN 934 M10
34		020-DIN912-M6X20	4	TORNILLO ALLEN DIN 912 M6X20
35		020-DIN933-M10X25	6	TORNILLO HEXAGONAL DIN 933 M10X25
36		040-FL-00002	1	FILTRO DE ASPIRACION 1/2"
37		040-RMM-00004	1	RACOR MACHO MACHO 1/2"
38		040-BH-00002	1	BOMBA HIDRAULICA 1LO7.5DE10R
39		040-CA-00002	1	CAMPANA ACOPLAMIENTO BOMBA LO MOTOR 3 CV
40A		040-AE-00007	1	ACOPLAMIENTO ELASTICO LADO MOTOR PARA BOMBA TIPO LO MOTOR 3 CV

Nº ORDEN	DIBUJO	Nº PIEZA	CANTIDAD	DESCRIPCION
40B		040-AE-00009	1	ESTRELLA ACOPLAMIENTO 3/4/5.5 Cv
40C		040-AE-00008	1	ACOPLAMIENTO ELASTICO LADO BOMBA PARA BOMBA TIPO LO MOTOR 3 CV
41		050-ME-00003	1	Motor Eléctrico 2.2Kw 1500RPM 50-60Hz B5 220/380V
42		020-DIN933-M10X45	4	TORNILLO HEXAGONAL DIN 933 M10X45
44		040-JT-00023	1	JUNTA TORICA Ø80X5 90 Shore
45		040-BA-00010	1	JUNTA COLLARIN BA Ø70XØ80X11.4
46		120-02-01-00046	1	DOLLA DE BRONCE Ø90XØ70 X39
47		020-DIN912-M10X20	4	TORNILLO ALLEN DIN 912 M10X20
50		040-DPS-00003	1	DPS Ø150XØ133X20X40
51		040-JT-00006	1	JUNTA TORICA Ø158X5 90 Shore
53		020-I7380-M12X45	2	TORNILLO ALLEN ISO 7380 M12x45
78		020-DIN912-M12x45	13	TORNILLO ALLEN DIN 912 M12x45
57		020-DIN125B-M10	15	ARANEDLA DIN125B M10













HYDRAULIC PRESS MX340G

Nº ORDEN	DIBUJO	Nº PIEZA	CANTIDAD	DESCRIPCION
60		020-DIN934-M6	6	TUERCA DIN 934 M6
61		031-POMH-00009	2	POMO HEMBRA MATE EN ESTRELLA M6 D32 ALTO 20
62		020-DIN913-M6X16	2	ESPARRAGO ALLEN DIN 913 M6X16
67		120-02-01-00067	1	CHAPA FRONTAL AJUSTE FC
68		120-02-01-00068	1	CHAPA LATERAL DERECHA
69		120-02-01-00132	1	CHAPA LATERAL IZQUIERDA
70		120-02-01-00150	1	ENVOLTORIO POSTERIOR
79		120-02-01-00079	1	TOPE PISTON MX340
80		030-DP-00033	1	DOLLA PARTIDA-70-75-50
84		120-02-01-00084	1	Tope Extractor
85		020-DIN912-M8X30	1	TORNILLO ALLEN DIN 912 M8X30
86		031-MAG-00003	1	MANETA GRADUABLE M10x30
90		031-LLGU-8090	1	LLAVE GANCHO UÑA 80/90
95		122-PLC-0000-001	1	PLACA CARACTERISTICAS GENERAL

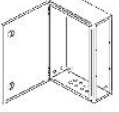



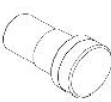







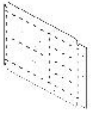

Nº ORDEN	DIBUJO	Nº PIEZA	CANTIDAD	DESCRIPCION
96		020-DIN7337-3X8	12	Remache De Clavo DIN 7337 De Al Ø3x8
97		120-02-01-00097	1	Puerta MX340G
98		031-CLT-00001	1	CIERRE DE LENGÜETA CON TRIANGULO 8 M20
98A		031-LLT-00001	1	LLAVE PARA CIERRE TRIANGULO DE 8 FLOTANTE NIQUELADA
99		031-BP-00001	2	BISAGRA DE PLASTICO 30
100		020-DIN7991-M6X12	8	TORNILLO ALLEN DIN 7991 M6x12
102		031-SIB-00001	2	SILENT BLOCK Ø20X15 M6
103		031-SIB-00002	2	SILENT BLOCK Ø20X15 M6 DOBLE ESPARRAGO
105		020-DIN933-M10X16	4	TORNILLO HEXAGONAL DIN 933 M10X16 8.8 PAVONADO
106		120-02-01-00106	2	PASAMANO ANCLAJE MÁQUINA
108		120-02-01-00108	1	TETÓN TOPE
110		020-DIN933-M6X16	2	TORNILLO HEXAGONAL DIN 933 M6X16
128		120-02-01-00128	1	POLICARBONATO PROTECCION
129		120-02-01-00129	1	LATERAL TAPA

HYDRAULIC PRESS MX340G

Nº ORDEN	DIBUJO	Nº PIEZA	CANTIDAD	DESCRIPCION
130		120-02-01-00130	1	CHAPA FRONTAL INOXIDABLE
131		031-MUE-00001	1	MUELLE PROTECCION FRONTAL
132		020-ISO7380-M6X10	16	TORNILLO ALLEN ABOMBADO ISO 7380 M6X10
133		020-DIN7337-4X10	6	REMACHE DE CLAVO DIN 7337 Ø4X10 ALUMINIO
134		031-POMH-00002	1	POMO DIAMETRO 40 M8
135		020-DIN913-M6X8	1	ESPIGA ALLEN DIN 913 M6x8
136		020-DIN913-M8X20	1	ESPARRAGO ALLEN DIN 913 M8X20
137		020-ISO7380-M4X30	2	TORNILLO ALLEN ISO 7380 M4x30 PAVONADO
138		020-DIN934-M4	10	TUERCA DIN 934 M4
139		020-DIN125B-M4	2	ARANDELA DIN 125-B M4
140		050-PL-00009	1	PILOTO SEÑALIZACIÓN ROJO Ø22
141		050-SLL-00001	1	SELECTOR DE LLAVE 2 POSICIONES Ø22
142		050-FC-00007	2	CAMARA FINAL DE CARRRA NC
143		050-FC-XCKP	1	FINAL DE CARRERA

Nº ORDEN	DIBUJO	Nº PIEZA	CANTIDAD	DESCRIPCION
144		050-PE-00002	7	PRENSAESTOPA PG-9
145		120-02-01-00122	1	SOPORTE EJE PROTECCION
146		050-PED-003	1	PEDAL DE ACCIONAMIENTO
147		050-IND-00002	1	DETECTOR BALLUF M5X0.5
148		020-DIN9021-M6	2	ARANDELA ANCHA DIN 9021 M4
149		020-DIN7337-6.5X12	6	REMACHE DE CLAVO DIN 7337 Ø6,5X12 ALUMINIO
150		122-CAL-0201-002	1	CALCA FRONTAL ALUMINIO
151		050-ARM-00002	1	ARMARIO ELECTRICO
152		120-02-01-00152	1	CHAPA FRONTAL CUADRO MX340G
153		020-DIN7991-M4X10	8	TORNILLO ALLEN DIN 7991 M4X10
154		122-CAL-0201-003	1	CALCA CUADRO MX340G
155		050-PL-00002	1	PILOTO SEÑALIZACIÓN BLANCO Ø22
156		050-PEM-22	1	PULSADOR PARO DE EMERGENCIA Ø22
157		050-PL-00008	1	PILOTO SEÑALIZACIÓN AZUL Ø22

HYDRAULIC PRESS MX340G

Nº ORDEN	DIBUJO	Nº PIEZA	CANTIDAD	DESCRIPCION
158		050-PUL-00004	1	PULSADOR AZUL Ø22
159		050-IG-00001	1	INTERRUPTOR GENERAL KG10AK300
160		020-ISO7380-M6X20	4	TORNILLO ALLEN ISO 7380 M6x20 PAVONADO
161		050-PE-00003	4	PRENSAESTOPA PG 13.5
162		130-02-01-00153	2	PANEL ELÉCTRICO MX340G
163		020-D9623-M8	4	TUERCA HEXAGONAL CON COLLAR BISELADO M8
164		120-02-01-00153	1	CHAPA SOPORTE ARMARIO ELECTRICO
165		040-MF-00005	1	Manguera hidraulica flexible cno codo 90º en ambos lados defasados 180º y tuerca giratoria de 3/8" gas long:2000
166		040-MF-00006	1	Manguera hidráulica flexible con codo de 90º - tuerca giratoria de 3/8" gas long: 1750 mm
167		120-02-01-00158	1	SUPLEMENTO ROSCA VASTAGO MX340
168		030-D7979D-00013	2	PASADOR CILINDRICO DIN7979/D D5X20
169		020-D6912-M8X25	2	TORNILLO ALLEN DIN 6912 M8X25
SC110		130-02-01-00201	1	DEPOSITO HIDRAULICO MX340G
SC111		130-02-01-00111	1	EXTRACTOR PROTECTOR ESTANDAR

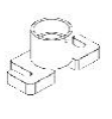
Nº ORDEN	DIBUJO	Nº PIEZA	CANTIDAD	DESCRIPCION
SC112		130-02-01-00205	1	CILINDRO MX340G
SC113		130-02-01-00209	1	PISTÓN MX340
SC114		130-02-01-00114	1	TOPE POSICIONADOR
SC115		130-02-01-00202	1	ARMARIO MX340G
SC116		130-02-01-00204	1	CUERPO CENTRAL MX340G
SC118		130-02-01-00118	1	CONJUNTO VARILLA REGULACION CARRERA
SC119		130-02-01-00119	1	PORTAMATRICES DE 85
SC120		130-02-01-00120	2	SOPORTE MICRO
SC121		130-02-01-00121	1	SOPORTE ÚTIL TOPE
SC130		130-02-01-00130	1	CONJUNTO SOPORTE PROTECCION
SC131		130-02-01-00131	1	CONJUNTO BIELA TOPE
SC132		130-02-01-00132	1	CONJUNTO PROTECCION

A2. Electric map · THREEPHASE MACHINE

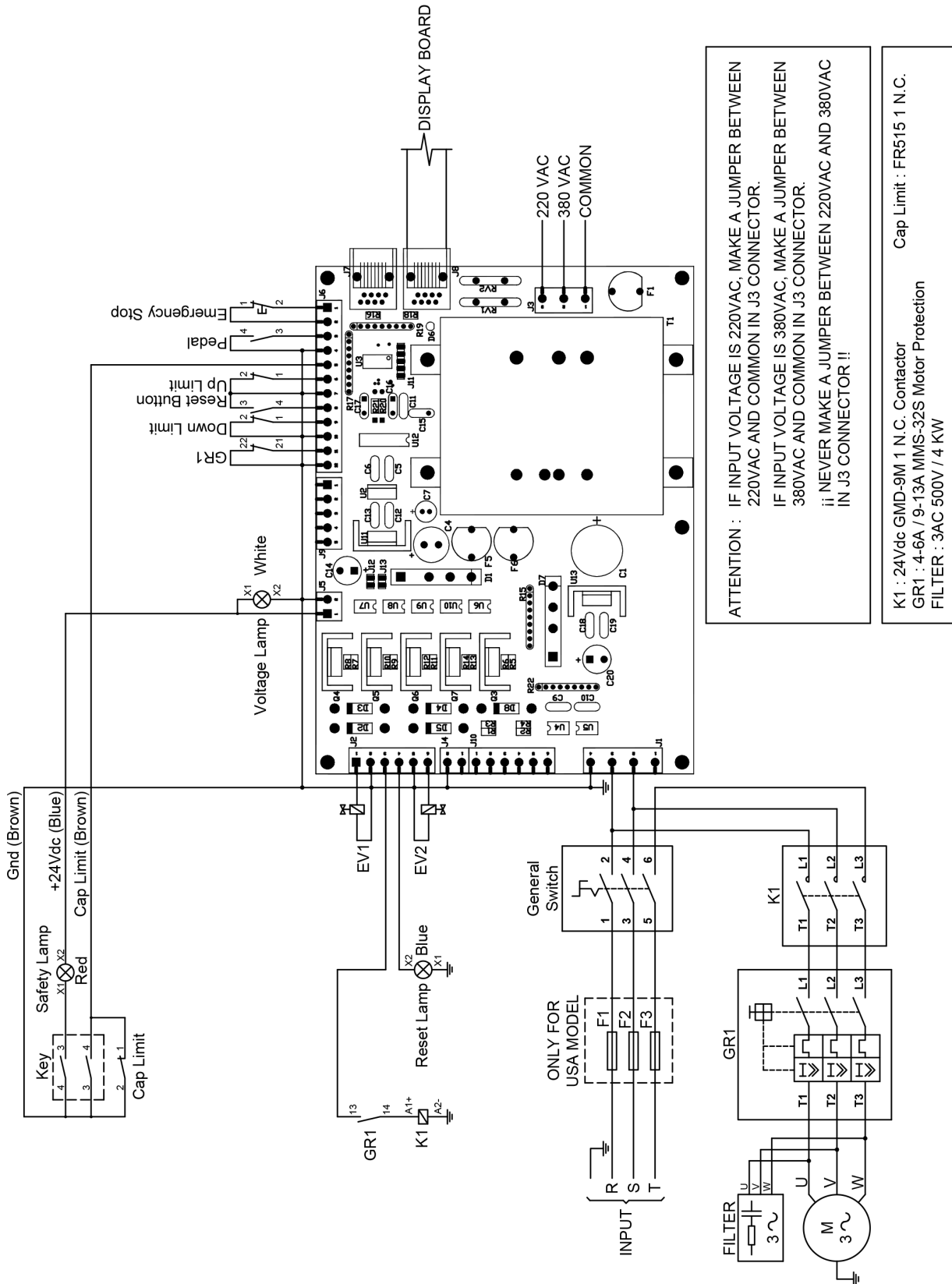

A3. Electric map · SINGLEPHASE MACHINE

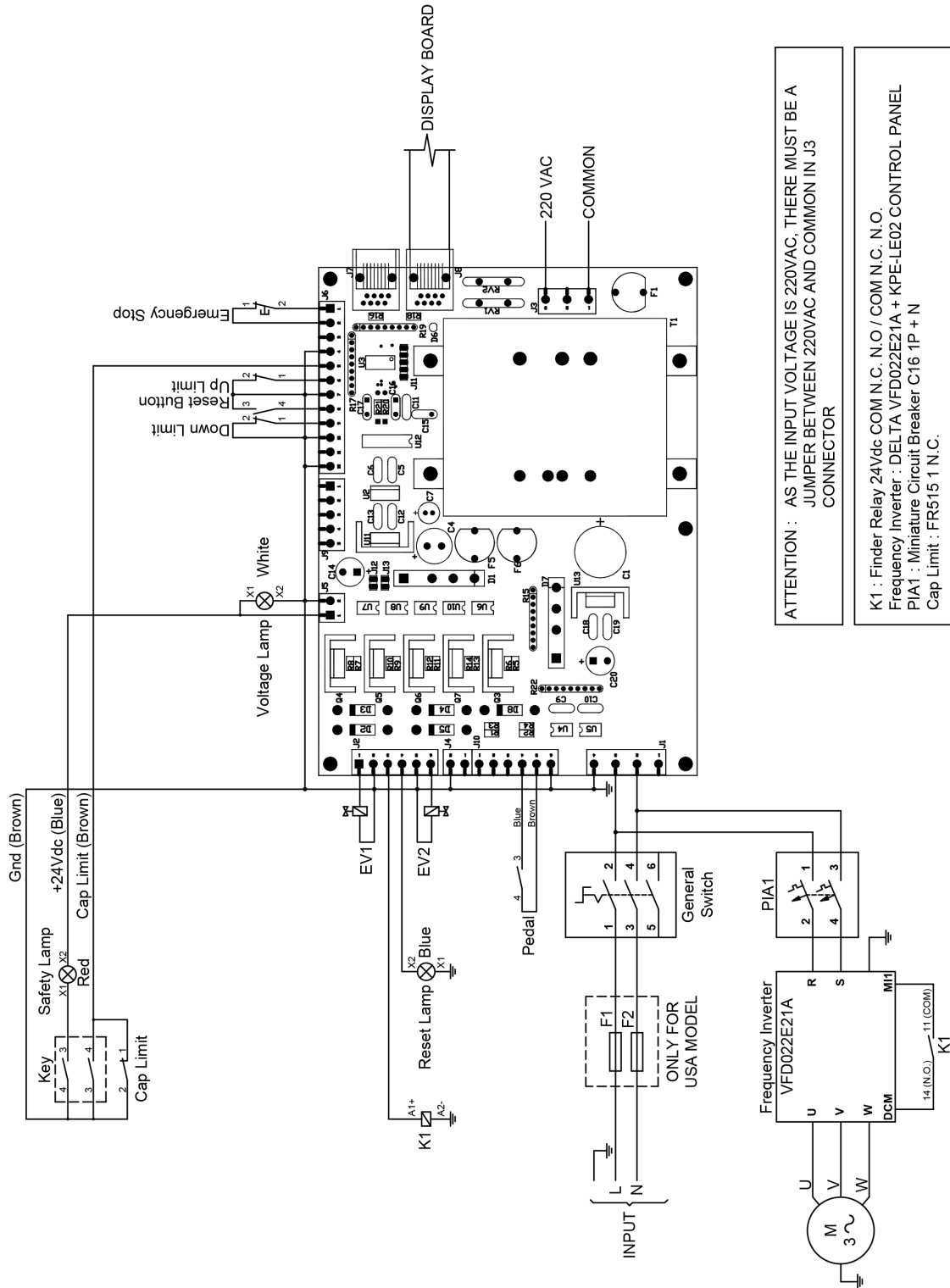

ATTENTION : AS THE INPUT VOLTAGE IS 220VAC, THERE MUST BE A JUMPER BETWEEN 220VAC AND COMMON IN J3 CONNECTOR

K1 : Finder Relay 24Vdc COM N.C. N.O. / COM N.C. N.O.
 Frequency Inverter : DELTA VFD02E21A + KPE-LE02 CONTROL PANEL
 PIA1 : Miniature Circuit Breaker C16 -1P + N
 Cap Limit : FR515 1 N.C.

A4. Hydraulic map

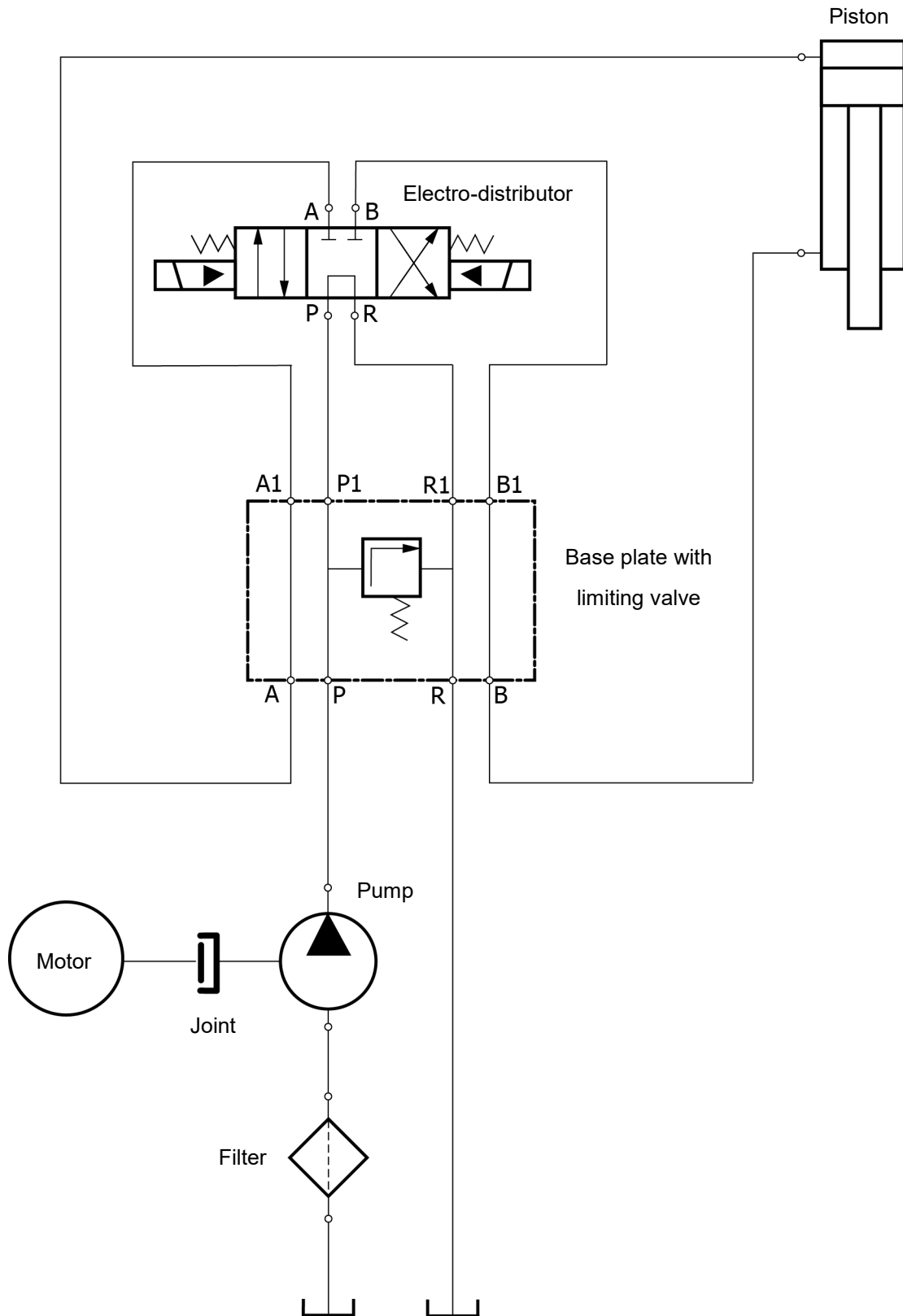

OUR RANGE OF MACHINERY



IRON WORKERS



SECTION BENDING MACHINES



NON-MANDREL PIPE BENDER



HORIZONTAL PRESS BRAKE



TWISTING/SCROLL BENDING MACHINES



HYDRAULIC PRESS BRAKES



HYDRAULIC SHEAR MACHINES

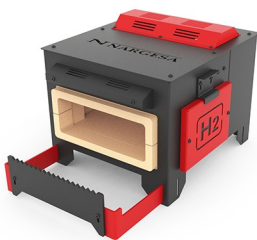

GAS FORGES



IRON EMBOSSING MACHINES



END WROUGHT IRON MACHINES



BROACHING MACHINES



POWER HAMMERS



PRESSES FOR LOCKS