

TWISTING MACHINE

MT500A

NS: 2023-517

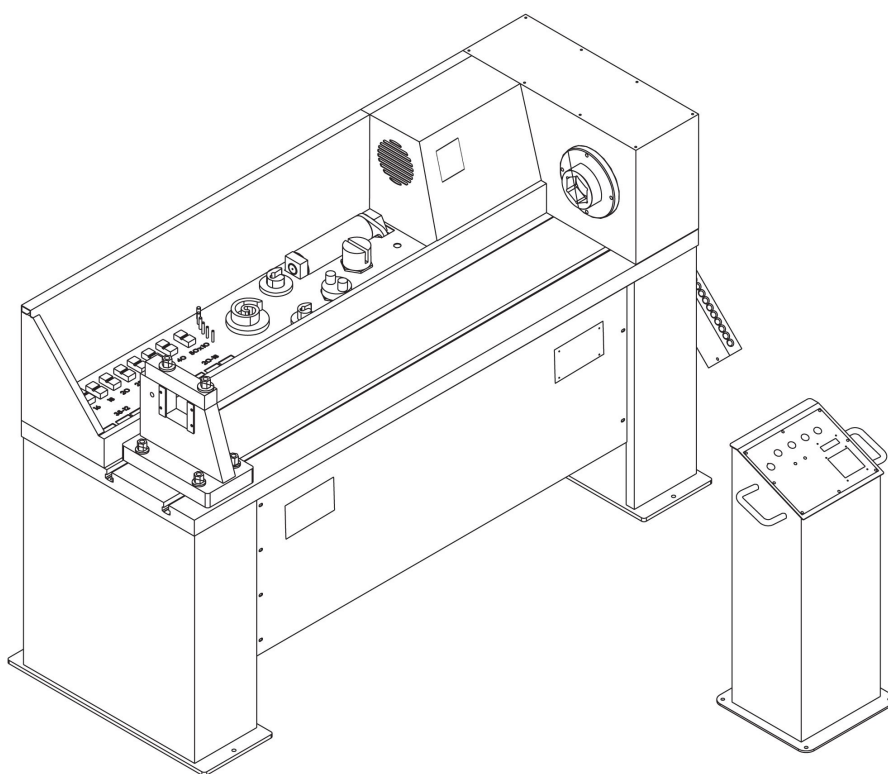

INSTRUCTIONS BOOK

PRADA NARGESA, S.L

Ctra. de Garrigàs a Sant Miquel s/n · 17476 Palau de Santa Eulàlia (Girona) SPAIN
Tel. +34 972568085 · nargesa@nargesa.com · www.nargesa.com

Thank you for choosing our machines



www.nargesa.com

INDEX

1. INFORMATION ABOUT THE MACHINE	5
1.1. Machine identification.....	5
1.2. Normal usage of the machine	5
1.3. Noise caused by the machine	5
1.4. Vibrations	5
1.5. Operative's natural working place	5
1.6. Description of the machine	6
1.7. Description of accessories	6
1.8. Description of safety devices	6
1.9. Basic characteristics of the tooling that can be fitted to the machine	7
1.10. Information related to the electrical equipment	7
1.11. Instructions to connect it to the power supply	7
1.12. Dimensions	7
2. TRANSPORT AND STORAGE	8
2.1. Transport	8
2.2. Storage conditions	8
3. INSTALMENT AND STARTING UP	9
3.1. Instructions to fix it	9
3.2. Admisible outer conditions	9
3.3. Safety systems for the operative	9
3.4. Periodicity of revisions	9
4. INSTRUCTIONS	10
4.1. Instructions for the adjustmen	10
4.2. Residual hazard. Danger caused by fitted elements	10
4.3. Information about forbidden usage methods	10
4.4. Instructions for learning	10
5. DETAILED EXPLANATION OF ITS PERFORMANCE	11
5.1. Introduction	11
5.2. Definition of the system	11
5.3. Frequency inverter	11
5.4. Description of the machine control	12
5.5. Equipment performance	12
5.6. Manual mode	12
5.7. Automatic mode	13

5.8. Using the equipment	15
5.8.1. Activation of the machine	15
5.8.2. Starting up the machine	15
5.8.3. Machine in StandBy	15
5.8.4. Left turning direction	16
5.8.5. Machine in StandBy	16
5.8.6. Right turning direction	16
5.8.7. Machine in StandBy	16
5.8.8. Programming the torsion of one piece	17
5.8.8.1. Finding the starting point	17
5.8.8.2. Confirm the starting point of the torsion	17
5.8.8.3. Definition of the kind of torsion	18
5.8.8.4. Performing the torsion	18
5.8.8.4.1. Square torsion	18
5.8.8.4.2. Circle torsion	18
5.8.8.5. Finishing the torsion	19
5.8.8.6. Pulling out	19
5.8.9. Machine in StandBy	19
5.8.10. Repetition of an existing torsion	19
5.8.10.1. Selection of the memory to be repeated	19
5.8.10.2. Performance of the selected memory	20
5.8.11. Machine in StandBy	21
5.8.12. Counting of manufactured pieces	21
5.8.12.1. Selection of the memory to be displayed	21
5.8.12.2. Delete the counting of manufactured pieces	22
5.8.12.3. Do not delete the counter for manufactured pieces	22
5.9. Solution of problems and emergency situations	22
5.9.1. Emergency stop	22
5.9.2. Interruption of electrical supply	23
5.9.2.1. When there was no torsion in process	23
5.9.2.2. When there was a torsion in process	24
5.9.3. Loss of reference	24
5.10. Selection of language and model	25
6. STANDARD TOOLING	27
7. OPTIONAL TOOLING	30
8. MAIN STEPS TO FOLLOW FOR A FAST PROGRAMMING OF THE MACHINE	32
8.1. Starting screen	32

THECHNICAL ANNEX

1. INFORMATION ABOUT THE MACHINE

1.1 Machine identification

Trademark	Nargesa
Type	Twisting machine
Model	MT500A

1.2 Normal usage of the machine

The machine has been basically designed to shape cold forge materials. It scrolls bars, it makes spirals of flat bars, etc. All drawings that can be made with a rotary head and a stand point will be easily makeable by using this machine. It will only be limited by the room it occupies and the engine power.

A set of standard tooling is supplied along with the machine, with which you will be able to make most of the basic shapes. However the manufacturer can provide the user with the fitting mould for the head, so he can create his own shapes.

Si se produce un accidente por negligencia del operario, por no atenerse a las normas de seguridad expuestas en el manual, PRADA NARGESA S.L no se hace responsable.

1.3 Noise caused by the machine

In this case noise could be considered as non-existent under normal working conditions.

1.4 Vibrations

Like noise, vibrations are almost non-existent for this a fixed machine and it has got a low head rotation speed.

1.5 Operative's natural working place

The first zone is the machine bench, to the left of the drive where the twisting operation and the coil making is made.

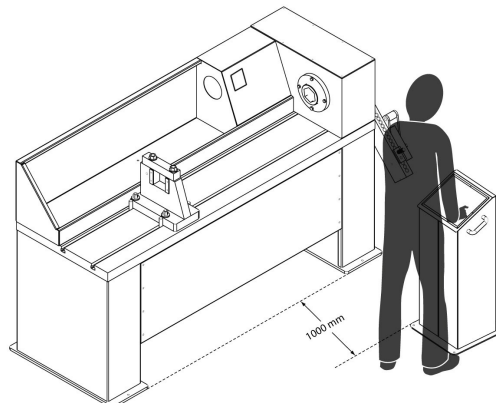

The second zone is the tooling area, to the right of the drive, where we make shapes by using a rotary drive and a fulcrum.

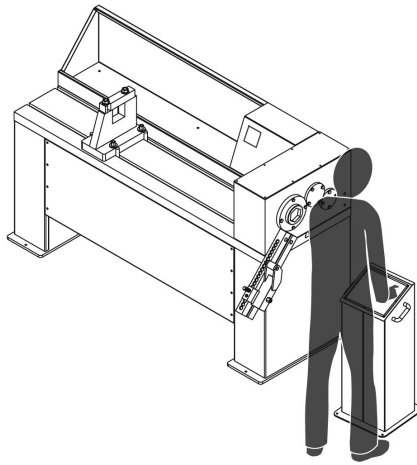

1.6. Description of the machine

The machine is equipped with a 5 HP engine and the reductor which transmits rotation to the head by means of a cog wheel.

It has a box to keep the tooling and a stand table made of a welded and folded steel plate.

Engine power	4 KW / 5,5 CV
Tension	230 / 400 V Three-Phase 230 V Single-Phase
Rotary speed	Adjustable from 0 to 10 r.p.m.
Twisting maximum capacity	40 mm o 1 3/8"
Bending Maximum capacity	25 mm o 1"
Max. scrolling & bending in flat bar	50x10 mm o 2"x3/8"
Max. Continued scrolling length	1.620 mm
Dimensions	2200x800x1270 mm
Weight	1350 Kg

1.7. Description of accessories

The basic accessories the machine has are the ones to fit the head to make the different shapes. It is provided with different stand points, and clamping spots for materials. In the last chapter of this manual there are a series of operations all of them explained step by step by means of photographs.

1.8. Description of safety devices

Gears and moveable parts are covered with the exception of the rotary head.

1.9. Basic characteristics of the tooling that can be fitted to the machine

Making sure that the accessories that are to be fitted to the machine have the same clamping so they can be thrown out or get loose is the only thing to bear in mind to use them.

1.10. Information related to the electrical equipment

The machine has a 230/400V three phase engine, connected star like when the line tension is 400V and connected in triangle when the three phased line tension is 230V, as it is indicated below:



Likewise it is necessary to change the input transformer terminals for the change of tension. Input 400 V. (Terminals “0” and “400”). Input 230 V. (Terminals “0” and “230”).

This modification must be carried out in the connector to the electric card.

See the sketch to get the steps in detail:

1.11. Instructions to connect it to the power supply

It must be only connected to one power supply in the indicated source. If the line tension is not the correct one, then it will be necessary to change the connection of the engine bobins, the frequency inverter must be replaced by one with three phase 230V input.

It is very important to connect properly the machine to the ground socket.

1.12. Dimensions

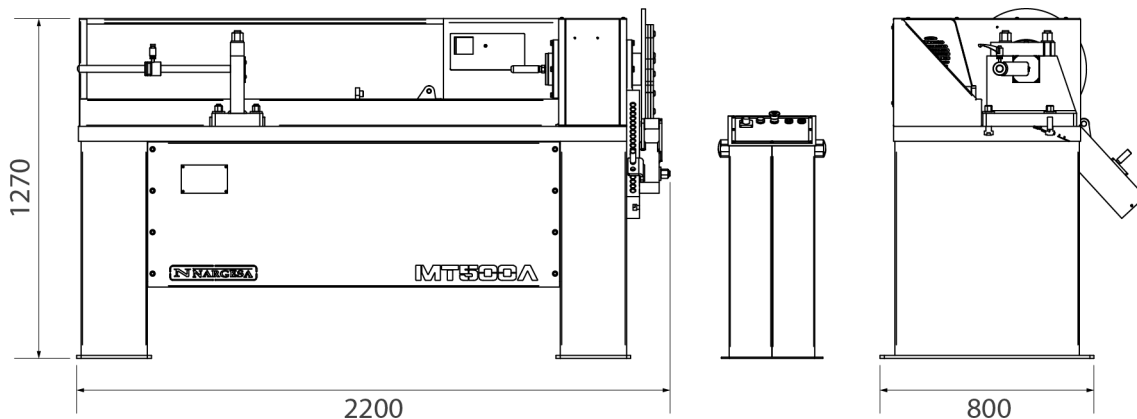

2. TRANSPORT AND STORAGE

2.1. Transport

Transport will be made by means of a forklift truck.

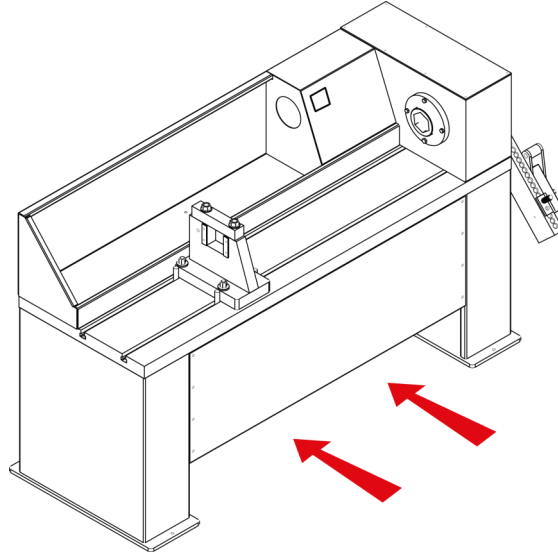

2.2. Storage conditions

The machine should be stored in place with the following requirements:

- Humidity between 30% and 95% without condensation.
- Temperature from -25°C to $+55^{\circ}\text{C}$ or $+75^{\circ}\text{C}$ for a length of time no longer than 24 h.
- It is advisable not to pile up machines or heavy objects on top of them.
- Do not disarm for its storage.

3. INSTALMENT AND STARTING UP

3.1. Instructions to fix it

When the machine is put down by the crane it will be necessary to do it correctly so it doesn't have to be moved once it is on the floor. If it isn't possible then put in a moveable base in order to transport it to the final proper location.

The machine will be fixed on the floor by its own weight, thus it is very important to put it in a flat and even surface.

3.2. Admissible outer conditions

- Environmental temperature: Between +5°C and +40°C without exceeding +35°C as average temperature during 24h.
- Humidity: Between 30% and 90% without water condensation.

3.3. Safety systems for the operative

The final place location for the machine must be estimated counting on the space that the material bar will be occupying while being shaped.

Never ever touch the material bar while the machine is performing.

3.4. Periodicity of revisions

Check up the oil level every 2000 hours of performance.

4. INSTRUCTIONS

4.1. Instructions for the adjustment

This machine hasn't got any adjustable element with the exception of any kind of repair.

4.2. Residual hazard. Danger caused by fitted elements

Always keep in mind not to put hands in the moveable parts of the head since it may cause the shearing off of arms or fingers.

4.3. Information about forbidden usage methods

Do not use tooling that are not provided by the manufacturer to prevent from the breaking of any element that might cause damage to the user.

4.4. Instructions for learning

In order to learn how to use this machine, placing the basic tooling and notice how to place the stand points, please, see the sequence of pictures in the last section of this manual. There are different thick parts and tops in the tooling box to adjust the proper height to fit them.









5. DETAILED EXPLANATION OF ITS PERFORMANCE

5.1. Introduction

The electronic control system has been designed in a specific way to rule, either MT500A, or MT150A. Since these two machines have similar characteristics, what's above will be easily understandable and therefore, from now on, when we refer to any of them we will just mention a generic name, such as "the machine".

5.2. Definition of the system

The plate described has a control zone on its right side, and it is composed by a two lines display with 16 features each, that is to say, a 2x16 display and a 16 keys keyboard with the following functions.

-  Left turning
-  Right turning
-  Control of manufactured pieces or CNT
-  Escape
-  Programming
-  Definition of square torsion
-  Definition of circle torsion
-  Pull out
- | | | | |
|---|---|---|---|
| 1 | 2 | 3 | 4 |
| 5 | 6 | 7 | 8 |

 Memory for pieces

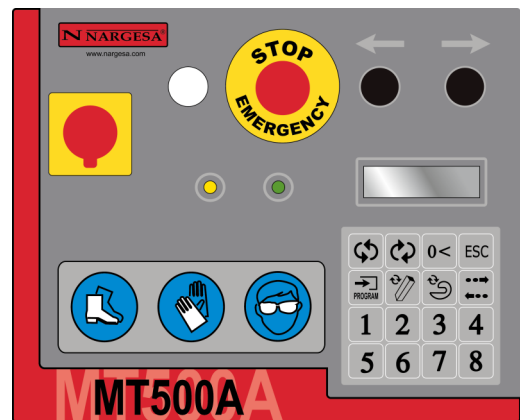

Frequency inverter

The frequency inverter allows us to modify the head turning speed.

Máximum values for admisible frquency are the ones indicated on the chart attached, according to the size of the material to be twisted.

MAXIMUM FRQUENCY	MATERIAL SIZE
100 Hz	12 mm
100 Hz	14 mm
100 Hz	16 mm
100 Hz	18 mm
100 Hz	20 mm
90 Hz	25 mm
80 Hz	30 mm
65 Hz	35 mm
60 Hz	40 mm

5.3. Description of the machine control



Left and right turning of the head. In order to use the machine manually, just press one of them.



Key to delete the counter of one memory



Press this key to initialize the machine each time is started up or the stop button is pressed. Press "Escape" key in order to cancel one operation.



This key is used to program the starting point



These two keys allow the selection of the kind of torsion. If the circle torsion is selected then the machine will only permit the torsion to the left direction.



This key is to validate the programmed extraction

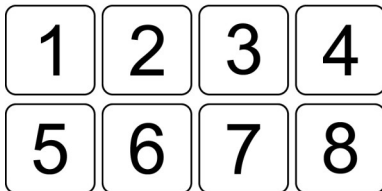

All keys for the memories. They can save up to 8 kinds of torsion. The head will find the starting point programmed in the memory when one of these keys is pressed. The second time it is pressed the machine will start scrolling the programmed torsion. Each memory has its own counter and it could be set to zero whenever desired.

5.4. Equipment performance

The exposed system offers the possibility to work in two different modes, manual and automatic.

5.5. Manual mode

The machine works on this manual mode on default, however it is to be pointed out that when it comes to a mass production of pieces in a same memory, the best way is to work on the automatic mode.

In this manual mode it is permitted to turn right and left by using the two buttons mentioned before, so the user can twist the pieces as he likes.

Performance is as simple as to press one of the buttons, then the lathe turns until the user quite pressing the button.

When the user decides that he's got a good point to start the piece, He inserts it in the mould of the lathe and makes the torsion of it, either in one direction or the other depending on the selected button. In order to end up the torsion just quit pressing the button that was being pressed.

Now that you have the twisted piece, it is advisable to press the button for "Turning left" or "Turning right" so the lathe goes back a few degrees, opposite to the direction the torsion had been made, in order to make the piece goes out easily, all since it is a bit difficult at times to get the piece out of the mould. (Keep in mind all restrictions according to the kind of torsion, the pulling out will be always carried out the opposite direction to the one the torsion has been made).

5.6. Automatic mode

The performance principle of the machine is the same one of that in the manual mode, the only difference is that this mode is used more for the mass production, in which it comes to be a bit slow the use of the machine in the manual mode.

As in our starting point, the user must specify the starting point of the torsion to be made, once the die has been inserted in the machine. It is required to press the *Programar* key (there will appear a message in the display Reading *Define the starting point of torsion*). Then, he must specify the starting point the machine needs to define the torsion by using the keys for *Turning left* and *Turning right*. So when a proper point is found to introduce the piece in the die stop pressing the turning button to one or other direction and press again the *Programar* (it appears in the display a label reading *Define kind of torsion*). Once here the user must select whether he wants to make a circle or square torsion since he has already inserted the piece into the die This is made by means of the proper button, may be the key for *Circle torsion*, or the key for *Square torsion* (it appears a label on the display reading "Define torsion, N°P:00 Ref:0000"). It is important to point out that in the circle torsion is only permitted to make torsions to the left direction for safety reasons. On the other hand, regarding the square torsion, the user can make torsions to both directions, however once the torsion has been started, it is not possible to go back or change direction until it is completely finished.

Now the user should be pressing the Turn left , or Turn right button (keep in mind restrictions regarding each kind of torsion), to make the torsion of your piece. When you estimate the piece is finished, you should press the button according to one of the 8 available memories (Buttons for *Memory*, in order to register the piece that has been made (a label will show up on the display reading: *Registering torsion n. Ref: nnnn*

Afterwards, (another message will show up Reading *Do pull out*. Now by using the buttons for *Turning right* and *Turning left* the user must specify the required point for the further extraction of the piece.

Then, he must be pressing the button for *Turning Right* or *Turning Left* bearing in mind all restrictions regarding the kind of torsion, the extraction of the piece will be always made in the opposite direction to the one the torsion has been made. Once the piece has been released, the user should press the button according to (Pulling out), in order to register the extraction operation on it once it has been carried out. However it is necessary to point out that in case the extraction operation does not allow to take the piece out easily, it will be necessary to repeat the whole process for programming the torsion.

In order to make the different part, the only thing to do is follow the steps up to now and then end up the operation by registering those torsions in the different memories.

It is not necessary to delete one memory in order to make one new torsion once you have all memories filled since the memory will be automatically deleted just by overwriting on an already existing memory.

In order to repeat one torsion that is already saved in a given memory, just press the button for the memory that defines the torsion to be made and follow the clear indications that are shown in the LCD display.

Moreover the user has the possibility to control the number of pieces made with each of the 8 memories that are available. For that, when it appears the label *Nargesa MT150A, in Stand By* or *Nargesa MT500A, in Stand By* (depending on the machine that he's working with), the user should press the button for *Control of the fabricated pieces* (a label will show up on the display Reading *Select Memory*). Once this has been done just select the memory to be visualized so a label will show up on the screen Reading: *Memory n°: 01, CNT to be deleted*. In case the user wants to delete this memory once he has checked the number of manufactured pieces on it, just press again the control key *CNT*.

Apart from what has been said up to now, the user has one key to escape *Escape* which enables him to go back to the screen on default *Nargesa MT150A, in Stand By*, which can be used whenever there is no torsion in process if it is so, then it is necessary to finish it before going back to stand by.

This system has also a safety device that makes the machine locate the starting point from which all references are taken, each time the machine is activated after having been stopped. So even though the machine makes a torsion again, it will find the memory that had been chosen for the torsion that is required now.

It also has a system for automatic control to spots if the machine has lost the point of reference by any given reason. It doesn't usually happen, however just in case, the user must follow the steps that are clearly indicated on the LCD display.

Last but not least, it is to be pointed out that the developed system has been designed according to the safety regulations, and that in case an emergency stop situation occurs the machine won't be able to be used again until it recovers all its normality when it will find the starting point of the machine again whenever the user presses the button for *Escape*, according to the new situation and following the indications given on the LCD display,) in order to guarantee that all references are still reliable.

5.7. Using the equipment

A graphic way is shown below detailing the steps to follow for reaching a correct performance of the machine, it comes to be like a part of the previous section. The different screens appearing at each moment with the aim of making it easier for the user to understand the functioning of MT150A and MT500A.

5.7.1. Activation of the machine

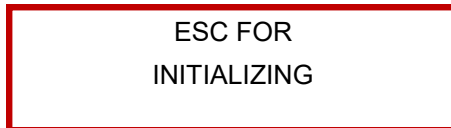

Picture 1. Screen for starting up the machine.

5.7.2. Starting up the machine

The user presses the "Esc" button

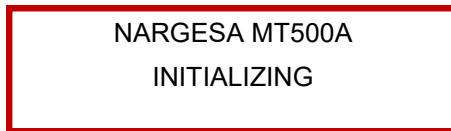

Picture 2. Screen for Initializing

In this moment the machine makes one turn, then it stops to locate its starting point. Then it will take the references according to this point.

5.7.3. Machine in StandBy

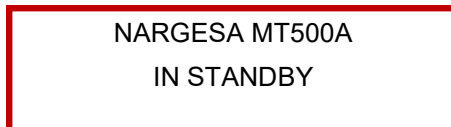

Picture 3. Screen for StandBy on default.

5.7.4. Left turning direction

The user presses the button for “Left Turning”



Picture 4. Screen for left turning.

5.7.5. Machine in StandBy

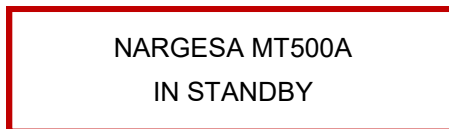

Picture 5. Screen for StandBy on default

When the user is not pressing any of the buttons, the machines enters into a StandBy mode.

5.7.6. Right turning direction

The user presses the button for “Right turning”.

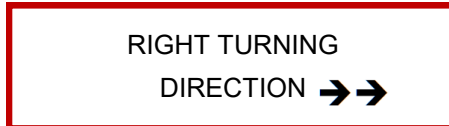

Picture 6. Screen for right turning

5.7.7. Machine in StandBy



Picture 7. Screen for StandBy on default

When the user is not pressing any of the buttons, the machine enters a StandBy.

5.7.8. Programing the torsion of one piece

The user presses the button for “Programming”.



Picture 8. starting screen to define onetorsion

5.7.8.1. Finding the starting point

The user I can either press te button for “Left Turning”

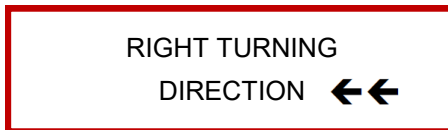

Picture 9. Screen for left turning

Or press the button for “Right turning”

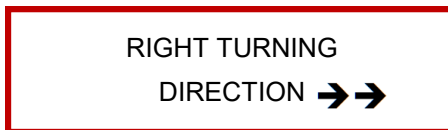

Picture 10. Screen for right turning

Until it reaches the point he thinks is the proper one to start twisteing the piece.

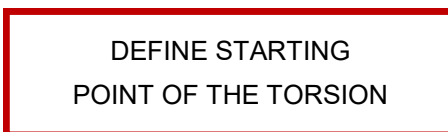

Picture 11. Starting screen for defining one torsion

5.7.8.2. Confirm the starting point of the torsion

The user presses the button for “Programming”



Picture 12. Screen to define the kind of torsion

5.7.8.3. Definition of the kind of torsion

The user can either press the button for “Square torsion”, or press the button for “Circle torsion”.

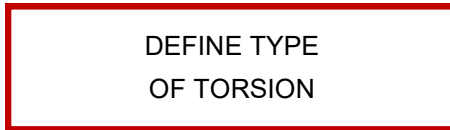

Picture 13. Screen to define the torsion

5.7.8.4. Performing the torsion

5.7.8.4.1. Square torsion

The user either press the button for “Turning left”, or the one for “Turning right”

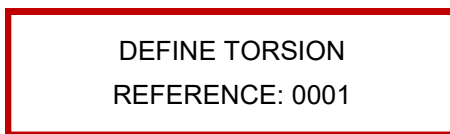

Picture 14. The reference shows the current situation of the torsion

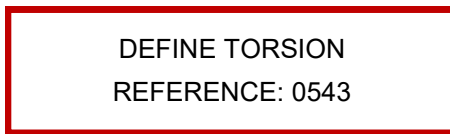

Picture 15. Until the piece has reached the desired torsion

5.7.8.4.2. Circle torsion

The user can only press the button for “Turning left”

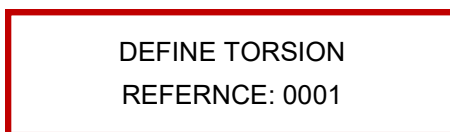

Picture 16. The reference shows the current situation of the torsion

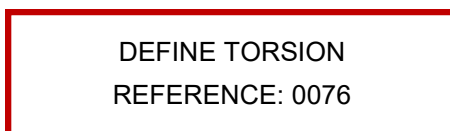

Picture 17. The reference shows the current situation of the torsion

Until the piece has reached the desired torsion

5.7.8.5. Finishing the torsion

The user should press one of the 8 buttons for “Memory”

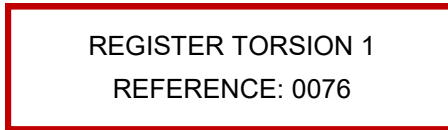

Picture 18. Screen for finishing the torsion

5.7.8.6. Pulling out

The user can only press the button for “Left turning”, or “Right turning”, according to the torsion direction



Picture 19. Screen for pulling out the torsion

The user should press the buttons for “Pulling out”

5.7.9. Machine in StandBy

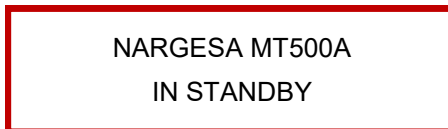

Picture 20. Screen for StandBy on default

5.7.10. Repetition of an existing torsion

5.7.10.1. Selection of the memory to be repeated

The user presses one of the 8 buttons for “Memory”, where there is a torsion registered



Picture 21. Automatic screen search of the starting point of the selected torsion

The machine turns until it finds the starting point of the selected torsion.



STARTING POINT 1
FOUND

Picture 22. Screen for the found starting point of the torsion.

5.7.10.2. Performance of the selected memory

The user presses again the same button for "Memory" he pressed before.



STARTS TORSION 1
N.P: 01 REF: 0000

Picture 23. Starting screen for performing the selected torsion

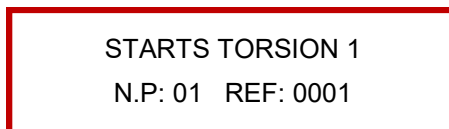

STARTS TORSION 1
N.P: 01 REF: 0001

Picture 24. The selected torsion starts to be made

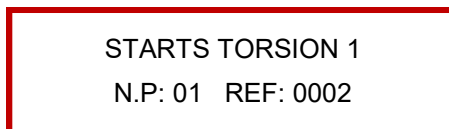

STARTS TORSION 1
N.P: 01 REF: 0002

Picture 25. The reference indicates de current situation of the torsion

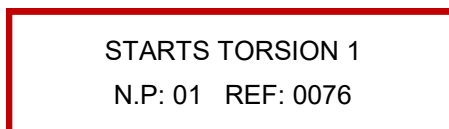

STARTS TORSION 1
N.P: 01 REF: 0076

Picture 26. The torsion is finished, it reaches the previously specified reference

The machine does the automatic Pull Out of the piece opposite direction to the one the torsion has been carried out.



Picture 27. The torsion is finished and the number of pieces has been increased in one unit.

5.7.11. Machine in StandBy

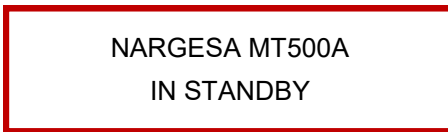

Picture 28. Screen for StandBy on default.

5.7.12. Control of manufactured pieces

The user presses the "CNT" button



Picture 29. Screen for the selection of the memory to be checked

5.7.12.1. Selection of the memory to be displayed

The user presses one of the 8 buttons for "Memory" according to the memory from which we need to keep control of the manufactured pieces.

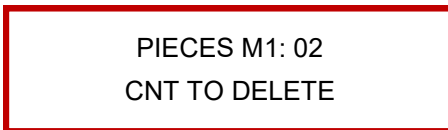

Picture 30. Screen for the control of the manufactured pieces

5.7.12.2. Delete the counting of manufactured pieces

The user press the “CNT” button

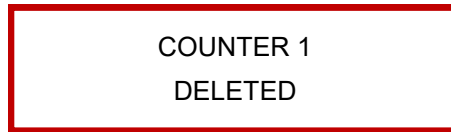

Picture 31. Screen informing about the deleted counter.

This screen will disappear 1 sec later and the machine enters in StandBy mode.

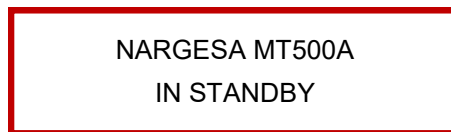

Picture 32. Screen for StandBy on default.

5.7.12.3. Do not delete the counter for manufactured pieces

The user presses the “Escape” button”

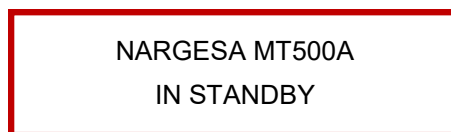

Picture 33. Screen for StandBy on default.

5.8. Solutions of problems and emergency situations

5.8.1. Emergency stop



Picture 34. Screen to indicate one emergency stop

Once the emergency situation is solved, the user should pull out the button for “Emergency stop”

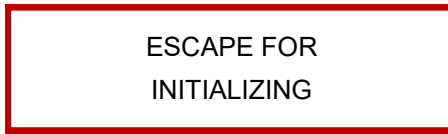

Picture 35. Screen to indicate it is necessary to re-start the machine.

The user should press the “Escape” button, bearing in mind that there might be one piece in the machine (It is possible to extract the piece before taking out this action by using the buttons for “Left turning” and “Right turning”)

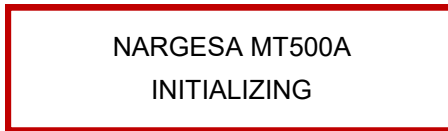

Picture 36. Screen for starting up

The machine will turn until it reaches its starting point, from which on all references are taken. It is then when the machine stops and enters in STandBy.



Picture 37. Screen for StandBy on default

5.8.2. Interruption of the electrical supply

5.8.2.1. When there was no torsion in process

Please, see section: 5.7.1. Activate the machine

5.8.2.2. When there was a torsion in process or any anomalous situation occurs

When the electrical supply is restored the machine shows the following label on the screen.



Picture 38. Screen to indicate there is a piece in the machine.

The user should take out the piece from the machine for his own safety. In order to do that and just in case, he can help himself from the movement the machine does if the buttons for "Left turning" and "Right turning" are pressed.

Once this has been done, the user should press the "Escape" button

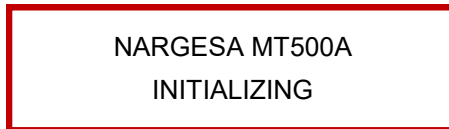

Picture 39. Screen to initialize the machine.

Now the machine turns until it reaches its starting point, from which all references for the torsion. The machine stops at this moment and enters in StandBy.



Picture 40. Screen for StandBy on default.

5.8.3. Loss of reference

Although it is not usual that a situation like this occurs, it might happen that the machine loses reference.

In case it happens the machine will show the following label in order to avoid the other pieces from being manufactured under wrong references.

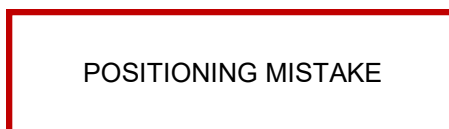

Picture 41. Screen indicating the loss of reference.

After some intermittencies, the machine shows on screen the following message.

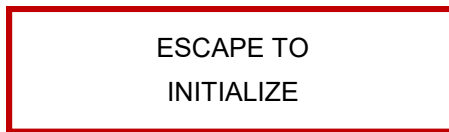

Picture 42. Screen to indicate the machine awaits confirmation to initialize.

The user should press the "Escape" button



Figura 43. Pantalla de inicialización.

Now the machine turns until it finds its starting point. In this moment the machine stops and goes to StandBy.

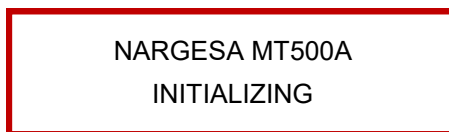

Picture 44. Screen for StandBy on default

5.9. Selection of language and model

This section is the most complicated of the control, because in case a mistake occurs when programming **It could cause irreparable damage to the machine and the control.**

So considering this, the user should obey and follow all steps described below.

Here the user will find the different screens presented at each moment in a detailed way in order to ease the understanding of the functioning of this machine.

By pressing the key "Left Turning Key" it will be possible to access this menu while the machine is being electrically supplied by the general switch. Once this has been carried out there comes the following information on screen.

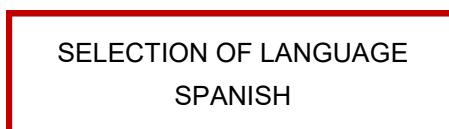

Picture 45. Screen for selecting the language

In order to change the language of the machine just press the following keys:

Key 1 : Español

Key 2 : English

Key 3 : Français

Key 4: Italian

 Polish

Then you will be able to see the selected language on the LCD screen. To confirm it, press the key for “Right Turning”.

Once here, the information on the screen will change into this other one:

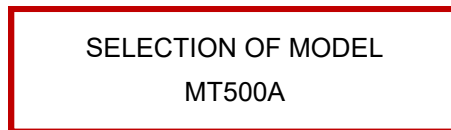

Picture 46. Screen for selecting the model

You can select among three different models by pressing these keys:

Key 5 : MT150A Single phase

Key 6 : MT150A Three phase

Key 7 : MT500A Three phase

Getting one of these options, the change of information will be shown in the screen. Once you agree with the model you want to choose, just press the key for “Right turning” in order to confirm it.

When you do that, there will appear one message on screen for initializing the memories to adjust them to the new model and the machine will restart for a correct performance.

6. STANDARD TOOLING

Tooling for Rings of 80mm.

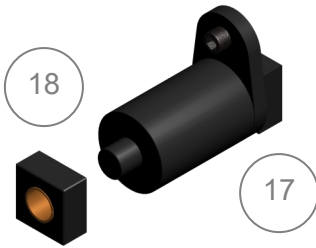

Tooling made of steel F1140 to make rings with inner diameter 80mm either in round or square bar.

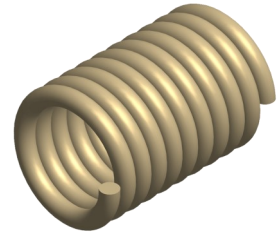

Tooling for links and hooks

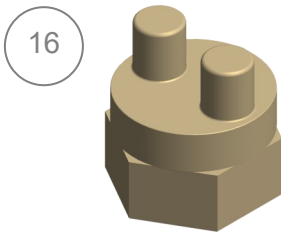

Microfusion treated tooling to make all kinds of folding operations, hooks, links, hooks, chains, etc...

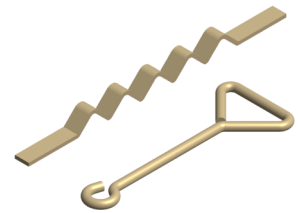

Flat bar bent Die

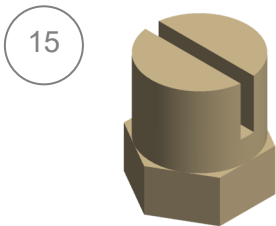

Treated Steel die for making flat bar folding operations, handrails or clods in all kinds. Folding with minimum external radius.

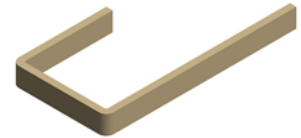

Spiral Tooling Diam. 120mm

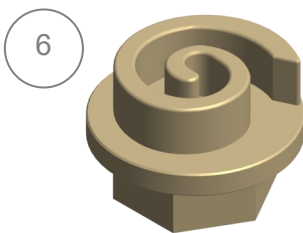

Tooling made of treated steel F1140 to make the second operation of the spiral in flat bar, square or round max. 10mm thickness.

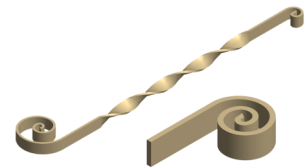

Spiral tooling Diam. 220mm

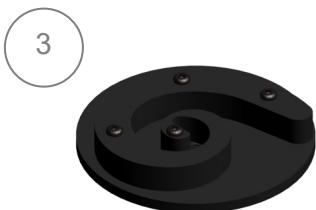

Tooling made of steel F1140 to make the second operation of the spiral in flat bar, square or round max 16mm thickness.

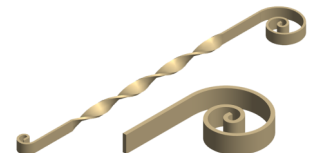

Spiral Tooling Diam. 450mm

1



Tooling made of steel F1140 to make the second operation of the spiral in flat bar, square or round max. 25mm thickness.



Tooling for Spiral Start Diam. 100mm

4

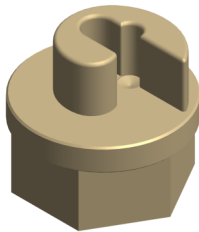

Tooling made of treated steel F1140 to make the start of the spiral in flat bar, square or round, 16mm maximum thickness.

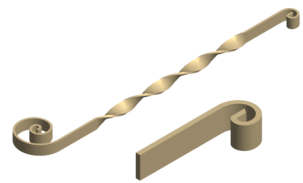

Tooling to make Spiral Start Diam. 180mm

2

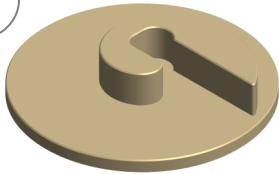

Tooling made of treated steel F1140 to make the start of the spiral in flat bar, square or round max. 10mm thickness.

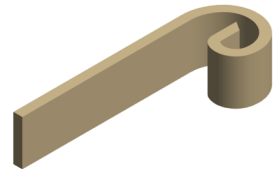

Tooling to make the Spiral Start Diam. 80mm

5

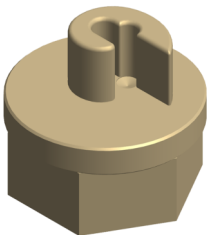

Tooling made of treated steel F1140 to make the start of the spiral in flat bar, square or round max. 10mm thickness.

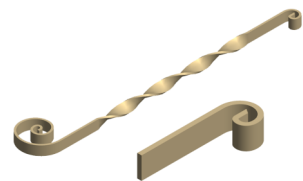

Tooling to twist square bar 12 and 35mm or 1/4" and 1 1/2" Inches Whitworth

20



Tooling made of treated steel F1140 to make twisting in 12x12mm and 35x35mm square bar or 1/4x1/4" and 1 1/2"x1 1/2" Inches Whitworth, in conventional carbon steel.

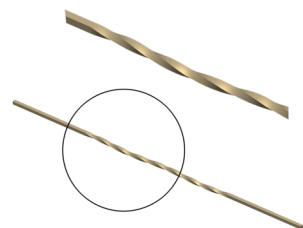

Tooling to Twist square 14 and 30mm or 3/8" and 1 1/4" inch Whitwort

21

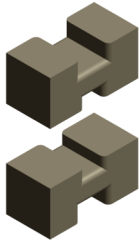

Tooling made of treated steel F1140 to make twisting operations in square 14x14mm and 30x30mm or 3/8"x3/8" and 1 1/4"x1 1/4" inches Whitwort, in Carbon coal.

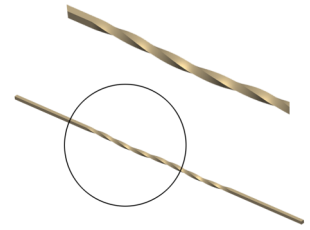

Tooling to twist square 16 and 25mm or 1" and 1/2" inches Whitwort

22



Tooling made of treated steel F1140 to make the twisting for 16x16mm square bar and 25x25mm or 1"x1" and 1/2"x1/2" inches Pulgadas Whitwort, in conventional carbon steel.

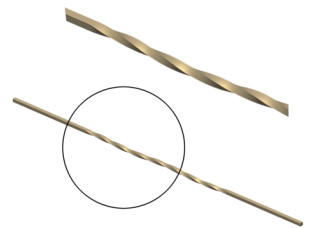

Tooling to scroll 18 and 20mm square bar or 3/4" and 5/8" inches Whitwort

23



Tooling made of treated steel F1140 to make twisting in 18x18mm and 20x20mm square bar or 3/4"x3/4" and 5/8"x5/8" inches Whitwort, in conventional carbon steel.

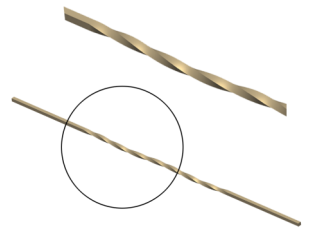

Tooling for Scrolling 40mm square and Flat bar 50x10 mm or 1 3/4" and 2"x3/8" inches Whitwort

24

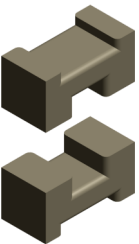

Tooling made of treated steel F1140 to make the scrolling in 40x40mm square bar and 50x10mm flat bar or 1 3/4"x1 3/4" and 2"x3/8" inches Whitwort, in conventional carbon steel.

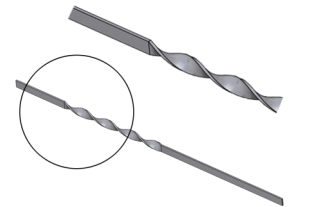

7. OPTIONAL TOOLING

Belly Top Railing



Steel die to make Belly top railing commonly used in balconies and windows.



Inner diameter

225 mm

Max. Capacity

Round or square 16 mm

Weight

12 Kg

Flat bent rings

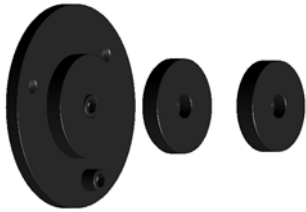

Steel Die to make round or square bent, the so called English railing.

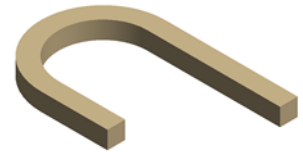

Inner diameter

96, 100, 110 mm

Max. Capacity

Round or square 16 mm

Weight

10 Kg

Edge scrolls die

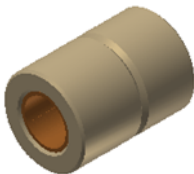

Treated Steel bar to make scrolls or edge spirals in order to give it a different styling touch, it is very used in specific countries.



Max. Capacity

Round or square 25 mm

Weight

0,400 Kg

Oval scrolls die

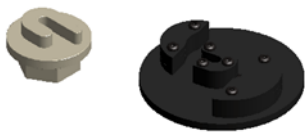

Steel die to make oval scrolls for all kind of railings.



Outer diameter

240x190 mm

Max. Capacity

Round or square de 16 mm

Weight

11 Kg

Bent pipe die up to 180°



Steel die to make curves in pipes with fixed and adjustable radius to different degrees..

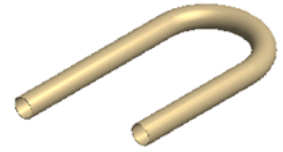

Pipe max. diameter	Pipe min. thickness	Piece radius	Degrees	Weight
40 mm	3 mm	3 x diam. del tubo	Max.180 grados	15/35 Kg

Double eye tooling



Steel die to make the shape known as double eyed bent, it is very used in balconies, railings and many other ornamental utilities.

Right, left and double operations.



Max. Capacity	Weight
Round 16 mm	35 Kg

Baskets tooling



Tooling to make all kinds of baskets, different sizes in square or round bars.

Available tooling for millimeter and inch square sizes



Max. Capacity	Weight
4 Square or round de 12 mm	55 Kg

8. MAIN STEPS TO FOLLOW FOR A FAST PROGRAMMING OF THE MACHINE

8.1. Starting screen



1 - Press it only once when we start the machine or when an emergency stop has been done.

ESCAPE TO
INITIALIZE



2 - Press it to enter programming.

NARGESA MT500A
IN STANDBY

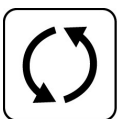

3 - Find the starting point of the torsion to be made by using the black set of buttons.

DEFINE THE TORSION
STARTING POINT



4 - Press for a second time to confirm the programming of the starting point of the torsion to be made.

DEFINE KIND
OF TORSION



5 - Choose one out of the 2 programming options, square or circle. With the first one it is possible to program in both turn directions, with the second option it will only be possible to program clockwise.

DEFINE TORSION
REF: 0000



6 - Make the torsion by using the black set of buttons, at once if possible. It is advisable to make the torsion using some material because of the different material hardness. The steps for the torsion operation could be seen on the screen.

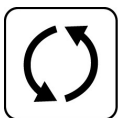

7 - Once the torsion has been made, the user should register it in one of the 8 memories of the number keys. Then the message below will show up on screen.

MAKE UNLOCK





8 - Do the pull out by using the black set of buttons, until you can get the material out.



It will only enable you to make the movement of the head the opposite direction to the one the torsion has been made.

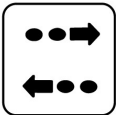

9 - Then press the pull out key and the torsion will be saved along with its pull out operation.

9.2. Mass production of pieces

10 - Once the operation is saved in a memory, if you press the head once it will find the starting point. Place the material in when it has stopped and fix it, then press the same key of the memory and the head will start making the torsion. These two operations are the ones you should be doing so you can make scrolls.

Technical annex

Forging twisting machine MT500A

Electric maps · Three-phase machine

Electric maps · Single-phase machine

Annex of electrical map

List of parts

Electric maps · Three-phase machine

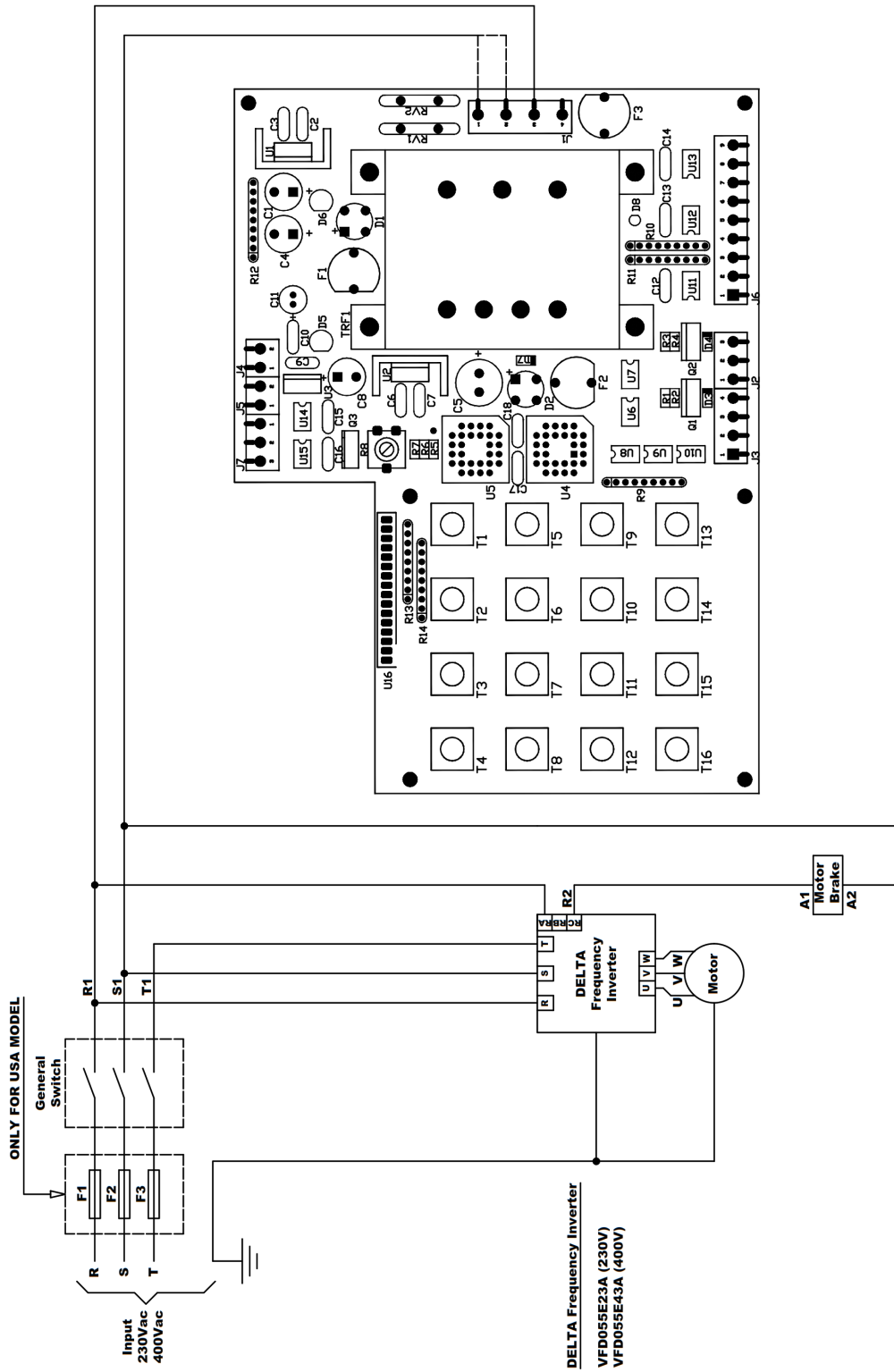

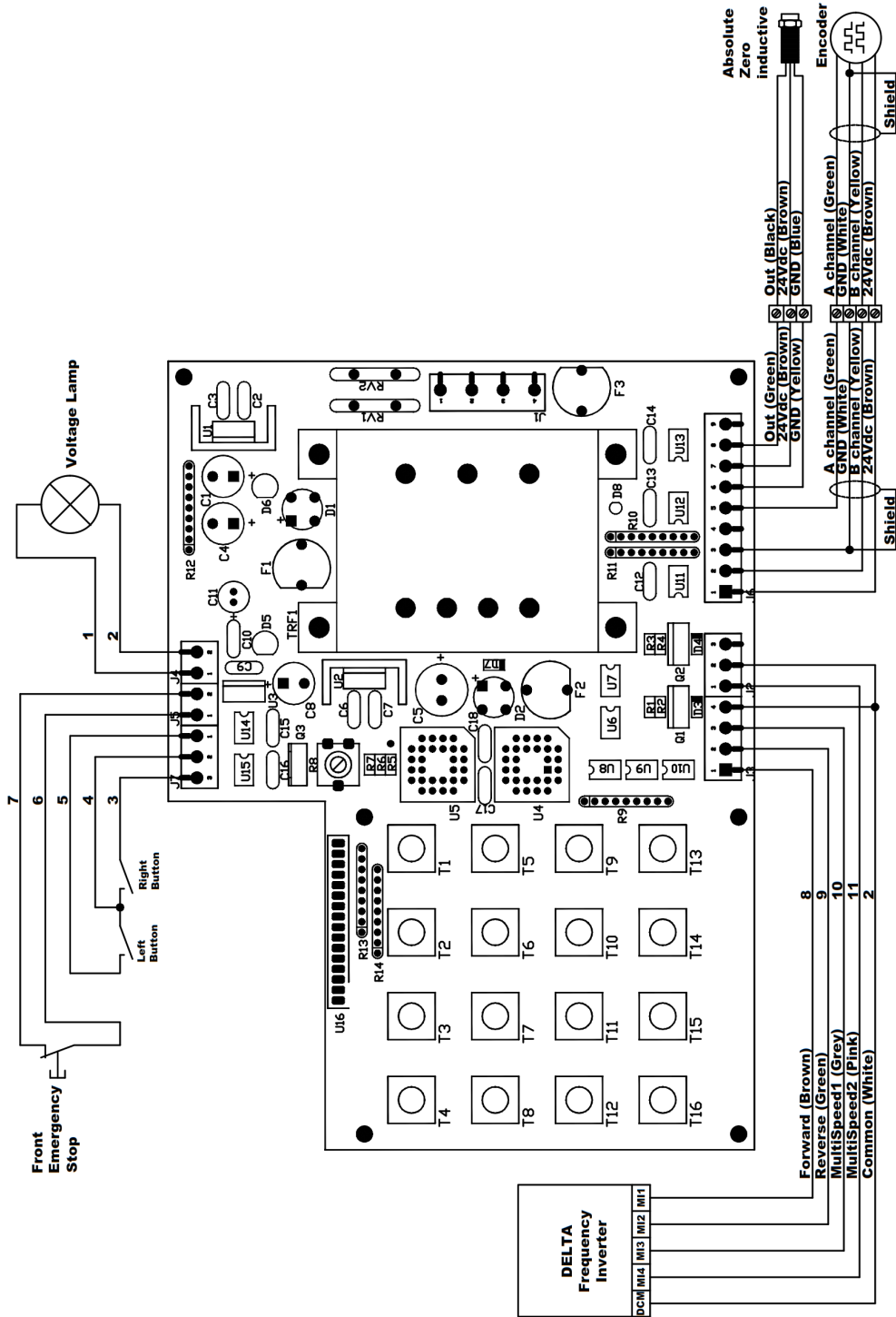

Annex of electrical map

Para 400 V

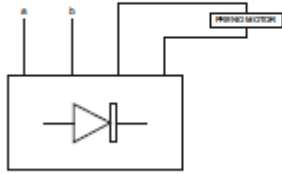

SS 2

Para 230 V

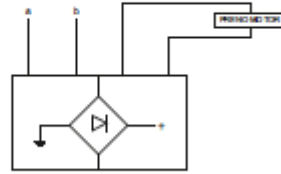

R 40 N

OUR RANGE OF MACHINERY



IRON WORKERS



SECTION BENDING MACHINES



NON-MANDREL PIPE BENDER



HORIZONTAL PRESS BRAKE



TWISTING/SCROLL BENDING MACHINES



HYDRAULIC PRESS BRAKES



HYDRAULIC SHEAR MACHINES

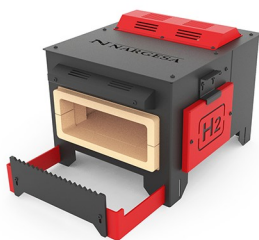

GAS FORGES



IRON EMBOSHING MACHINES



END WROUGHT IRON MACHINES



BROACHING MACHINES



POWER HAMMERS



PRESSES FOR LOCKS