

HORIZONTAL PRESS BRAKE

PP200CNC

NS: 2024-731

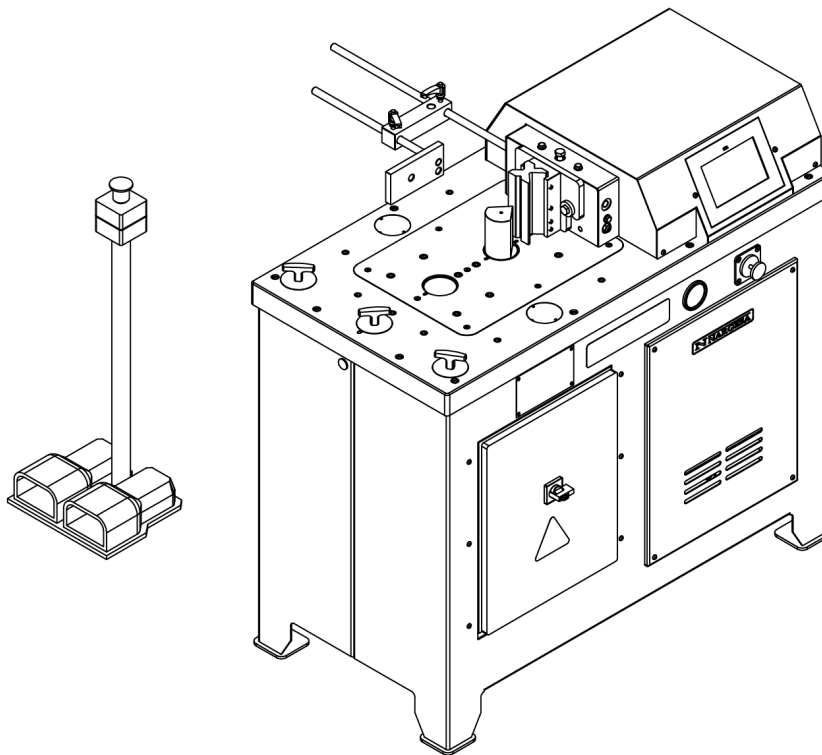

INSTRUCTIONS BOOK

PRADA NARGESA, S.L

Ctra. de Garrigàs a Sant Miquel s/n · 17476 Palau de Santa Eulàlia (Girona) SPAIN

Tel. +34 972568085 · nargesa@nargesa.com · www.nargesa.com

NARGESA CLIENTS

Prada Nargesa has more than 8.000 customers around the world. Some of our clients, those who offer service to third parties with the Nargesa machinery in their workshops, have been pleased to be part of this network that aims to connect them with possible future clients. In this way, all those people or companies that have a need for any part or tool that can be manufactured by using the Nargesa range of machinery, will be able to find a solution in their area to be able to satisfy their production requirements by hiring their services.



We have more than 8.500 customers in 150 different countries around the world

Discover its location on the interactive map on our website!

DO YOU WANT TO PARTICIPATE?

Send an email to nargesa@nargesa.com, include the following information and we will add you to this list.

We want to encourage all those who haven't participated yet in this great commercial network!

1. Company name
2. CIF/Tax Code
3. City
4. Country
5. Machine or machines

PRADA NARGESA

Prada Nargesa S.L. is a family business founded in 1970 located near Barcelona, Spain, with more than 50 years of experience in the sector of manufacturing of industrial machinery, and more than 10.000m² of facilities. Nargesa is a symbol of quality, reliability, warranty and innovation.

Our whole range of machines and accessories is manufactured entirely in Nargesa. We have a constant stock of 400 machines, and we have more than 16.800 machines sold all over the world.



Ironworker Machines

Ring Roller Bender and Pipe Bender

Non-mandrel Tube and Pipe Bender

Twisting / Scroll Bending Machines

Horizontal Press Brakes

End Wrought Iron Machines

Gas Forges

Iron Embossing Machines

Hydraulic Shear Machines

Hydraulic Press Brakes

Presses for Locks

Broaching Machines

Power Hammers

CERTIFICATES

Prada Nargesa has several certifications that backup both, the design and manufacturing processes, as well as the journey through exporting our products around the world and the quality of the manufacturing components we use for our machines. These facts turn into real advantages for our customers:



AUTHORIZED EXPORTER

- Faster customs procedures
- Reduction of tariff documentation
- Tariff preferences according to geographical location



INNOVATIVE SME

- Development in innovation, design and manufacturing technologies
- Certification and audit of efficiency in product and service
- Ability to foresee customer needs



R+D+I MANAGEMENT

- Manufacturing based on the R+D+I process
- Technological surveillance system

SUCCESS STORIES

At Prada Nargesa we believe that the testimony of our clients is our best guarantee, and that is why we like to expose some of the success stories that we have witnessed around the world:



Discover its location on the interactive map on our website!

DO YOU WANT TO PARTICIPATE?

Send an email to nargesa@nargesa.com including the following information and we will add you to our website

Company name

Testimonial name

Post in the Company

Country

Descriptive text

Photography with the machine

INDEX

1. CHARACTERISTICS OF THE MACHINE	3
1.1. Machine identification	3
1.2. General dimensions	3
1.3. Machine description	3
1.4. Identification of components	4
1.5. General characteristics	5
1.6. Identification of protective panels	5
2. TRANSPORT AND STORAGE	6
2.1. Transport	6
2.2. Storage conditions	6
3. MAINTENANCE AND CLEANING	7
3.1. Hydraulic maintenance	7
3.2. Cleaning	7
4. INSTALLATION AND START UP	8
4.1. Placement	8
4.2. Work area	8
4.3. Acceptable external conditions	9
4.4. Electrical connection	9
5. START MENU	10
6. PUNCHING	11
7. FOLDING	14
7.1. Folding correction	17
7.2. Automatic Mode and Manual Mode	17
8. SHEARING	18
9. MANUAL POSITIONING MODE	20
10. SAVING PROGRAMS	22
11. MENU	25
11.1. Remote assistance	25
11.2. Importing/exporting parameters, materials and programs	26
11.3. Touch screen calibration	27
11.4. Tool Management	28
11.4.1. Punching tools	29
11.4.2. Bending tools	31
11.4.3. Cutting tools	35
12. ADJUSTMENT OF THE WORKING STRENGTH	36
13. FAULT FINDING	37
12.1. Electrical faults	37
14. CAUTION	38
15. TOOLING	39

TECHNICAL ANNEX

TECHNICAL FEATURES - TOOLING

1. CHARACTERISTICS OF THE MACHINE

1.1. Machine Identification

Trademark	Nargesa
Type	Horizontal Press Brake
Model	PP200CNC

1.2. General Dimension

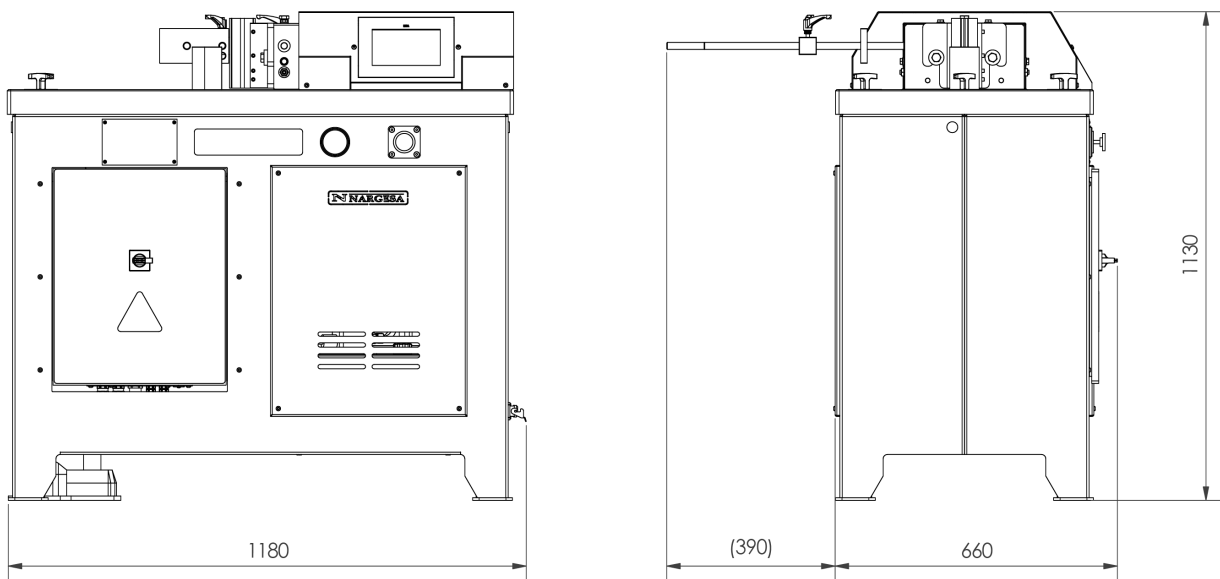

Figure 1. External Dimensions of the Horizontal Press Brake

1.3. Machine description

The versatility of the Horizontal Press Brake NARGESA PP200CNC allows us to carry out a large number of forging parts and operations depending on the need. This machine curves, cuts, shapes etc... depending on the type of accessory used.

A sample of the different types of accessories that can be applied is listed at the end of this manual.

1.4. Identification of Components

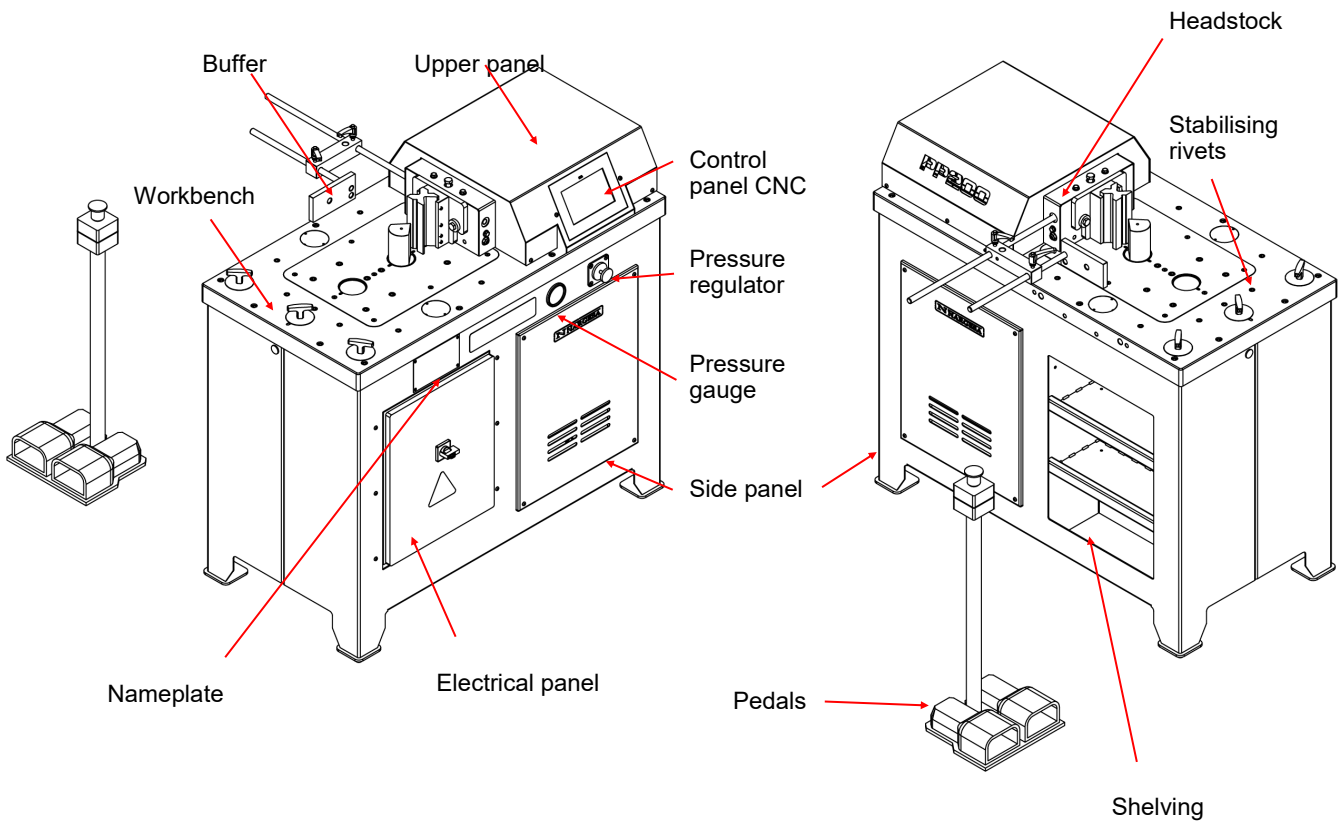

N NARGESA®		www.nargesa.com	CE
PRADA NARGESA, S.L. - CTRA. DE GARRIGAS A SANT MIQUEL S/N 17476 PALAU DE STA. EULALIA (GIRONA) SPAIN - TEL.(+34) 972568085			
TRADEMARK NARGESA	MODEL PP200		
YEAR OF MANUFACTURE	SERIAL N°		
DIMENSIONS 660x1180x1130	mm.	WEIGHT 665	Kg.
POWER 2,2 Kw.	INTENSITY 9/5 A.	VOLTAGE V.	Hz 50/60

1.5. General characteristics

Electric motor	2.2 Kw / 3CV at 1400 r.p.m.
Electrical power	230/400V Three-Phase 50/60 Hz 230V Single-Phase 50/60 Hz
Intensity	9/5 A
Hydraulic pressure	215 Kg/cm ² (21,5 MPa)
Hydraulic pump	7.5 litres/minute
Tank	27 litres
Maximum displacement	250 mm
Working strength	20.000 Kg (200 KN)
Dimensions	660x1180x1130 mm
Weight	665 Kg

1.6. Identification of Protective panels

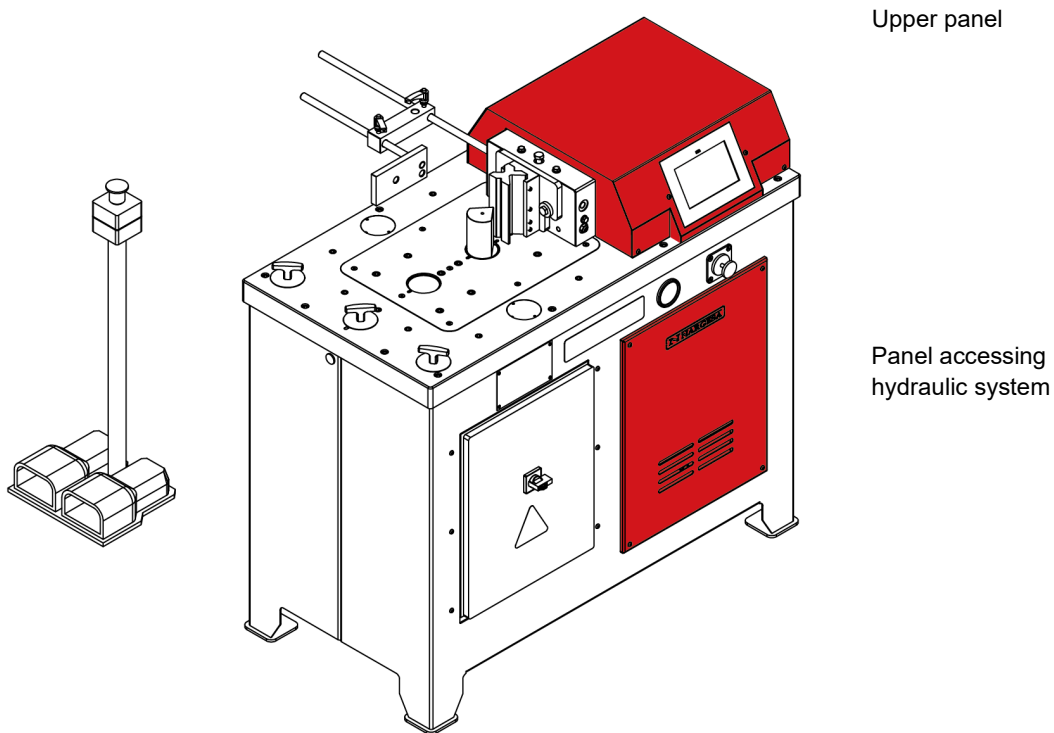

Figure 4. Position of security panels

It is PROHIBITED to work without the protective panels in place and should only be removed in case of a breakdown (if necessary) and always with the machine in the OFF position.

2. TRANSPORT AND STORAGE

2.1. Transport

The machine must be transported in an upright position using a forklift or a pallet jack fixed to the base of the machine (pre-designed for this purpose).

Please take into account the risk of the machine tipping over.

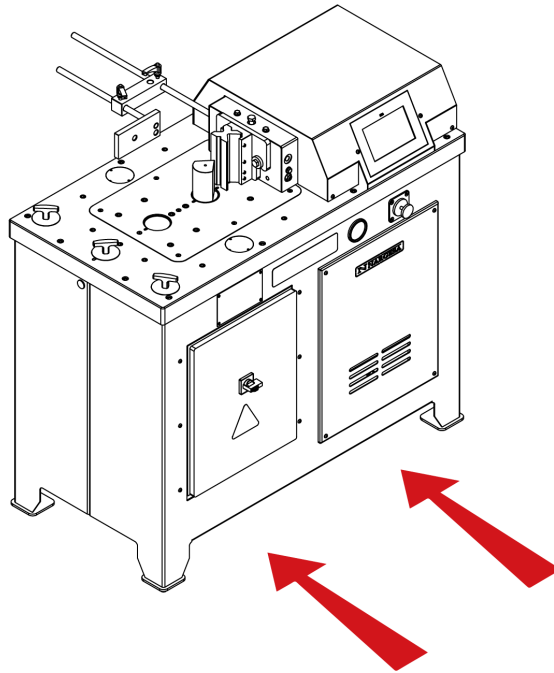

Figure 5. Transport of the machine

2.2. Storage conditions

- Humidity between 30% and 95% without condensation.
- Temperature between 15°C and 55°C.
- Don not place articles on top of the machine.
- Do not disassemble the machine for storing.

3. MAINTENANCE AND CLEANING

There are two aspects to take in to account with respect to the maintenance and cleaning of the Horizontal Press Brake NARGESA PP200CNC, these are:

- Hydraulic Maintenance
- Cleaning maintenance

3.1. Hydraulic maintenance

As the Horizontal Press Brake NARGESA PP200CNC possesses a hydraulic mechanism, it is necessary to periodically check the oil level tank. The machine is equipped with a low oil indicator (1) which permits us to observe the level of oil. This should be carried out with the machine on the standby and off position.

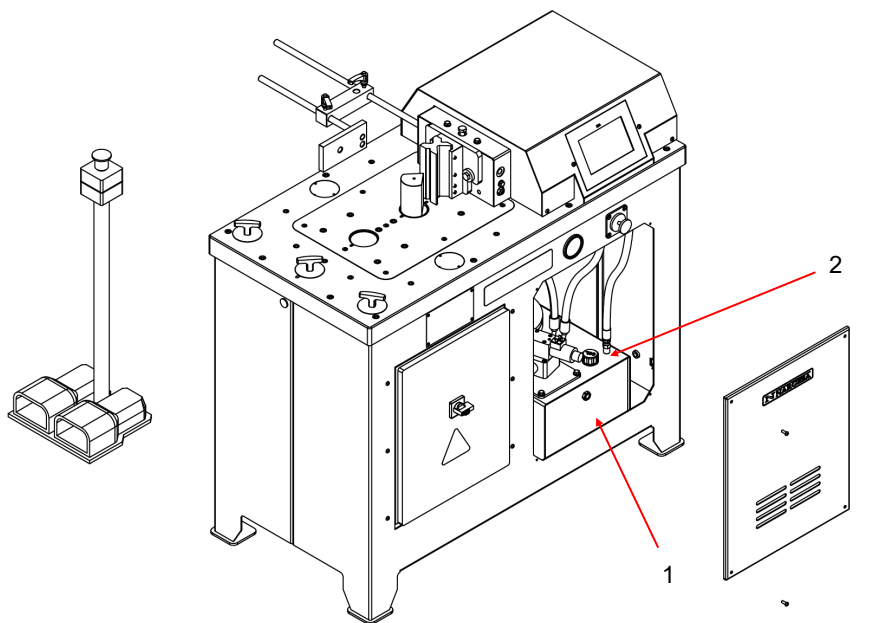

Figure 7. Positions of the Hydraulic maintenance elements

If the level is low it should be filled with hydraulic oil HM68 through the tank cap (2) until it is visible in the low oil indicator (1) (approximately half way up the indicator). This level should be checked once every three months.

3.2. Cleaning

The daily usage of the Horizontal Press Brake NARGESA PP200CNC can generate metallic waste such as (slag, shavings, etc.) which can damage the running of the machine. We recommend that the machine be cleaned, especially the work area, at the end of each day.

4. INSTALLATION AND START UP

4.1. Placement

The Horizontal Press Brake NARGESA PP200CNC should be placed on a flat, level surface. It is possible to secure it to the floor using the pre-made holes on the base of the machine for this purpose.

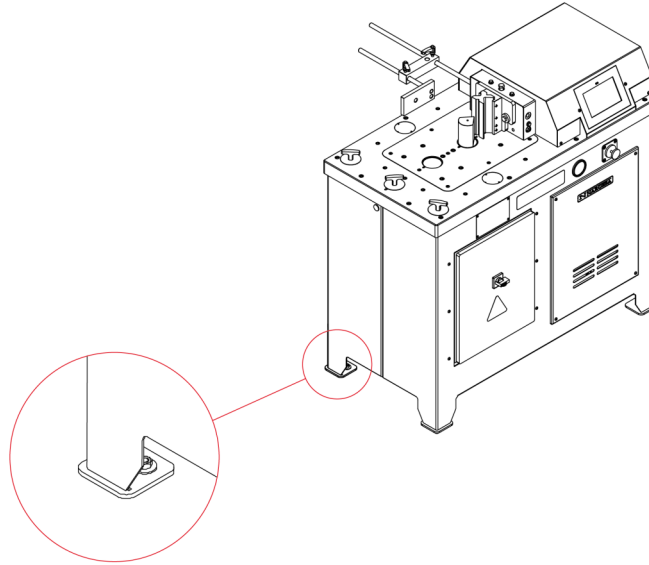

Figure 8. Anchor points

4.2. Work Area

Given the versatility of the Horizontal Press Brake NARGESA PP200CNC it is important to have the necessary working space, especially at the perimeters of the machine, taking into account that the maximum or minimum limitations will depend on the accessory used. The operator should stand behind the machine together with the pedals.

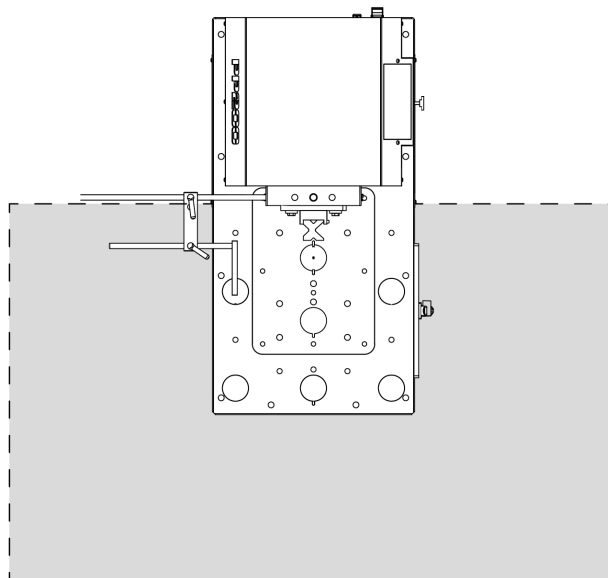

Figure 9. Work area

4.3. Acceptable external conditions

The working conditions of the machine can fluctuate between +5°C and +50°C being the maximum temperature and not exceeding an average temperature of +45° in a 24 hour period.

The humidity can fluctuate between 30% and 90% without condensation.

4.4. Electrical connection

The Horizontal Press Brake NARGESA PP200CNC is designed to be connected to a three-phase power supply of 230/400 volts at 50/60Hz.

Once connected ensure that the electric motor is turning in the correct direction (the direction indicated on the sticker placed on the motor) if this is not so, one of the phases must be relocated.

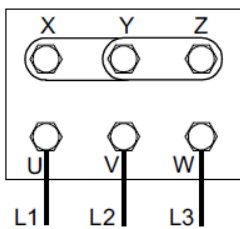

Star figure
(predetermined)
For 400V

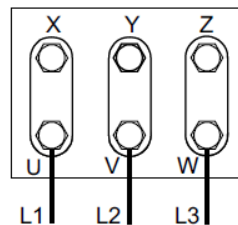

Triangular figure
For 230V

NOTE: If there is a change in voltage it will be necessary to modify the protectors of the electric motor following the table below:

VOLTAGE	MOTOR GUARD CONTACTOR
230 V	7 - 10 A
400 V	4 - 6 A

5. START MENU

To supply power to the machine, we must put the Start Switch in the “Connected” position. The initial interface or Start Menu shows up on the screen:



At this moment the machine is in Standby, that is to say, the machine is ON, but it remains in StandBy waiting to perform any function:



Punching



Folding



Shearing



Manual positioning mode

It is of utmost importance to remember at this point that PP200 press is delivered in “eco” mode. Why is this so important? Well, the reason is that the machine features an energy saving mode which firstly allows us to align ourselves with the necessary measures to slow down irreversible climate change (we’re an environmentally-aware company). And, secondly but not least importantly, it allows you as the customer to save the most energy when working so your end product is more price-competitive.

This “eco” mode basically turns off all tasks that consume the most energy if it detects a relatively long period of inactivity. Nonetheless and in order to avoid having to re-enable all the tasks you wish to work with, they will automatically turn on when you simply press the pedal.

6. PUNCHING

The following screen shows up when acceding to the Punching function:

To perform the punching function we must enter the following parameters in the CNC. In order to do this, we will press each of the following icons to select each parameter:



We press the key  to select the punch from the library

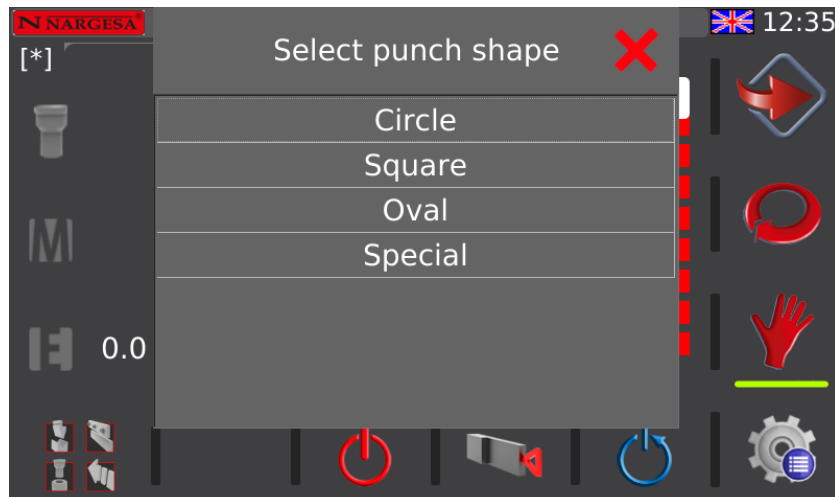

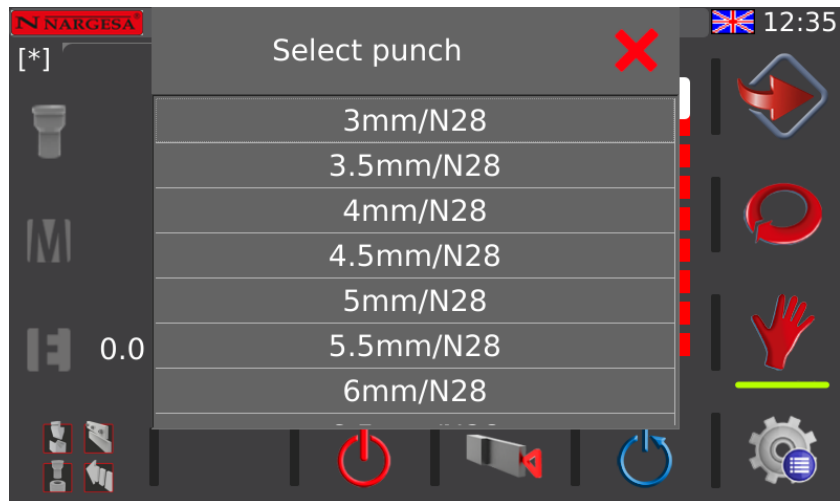

We note that the CNC automatically selects one or the other based on our choice. It means that, if when we select a punch, the CNC selects the appropriate die for that punch.

We press the key  to select the material

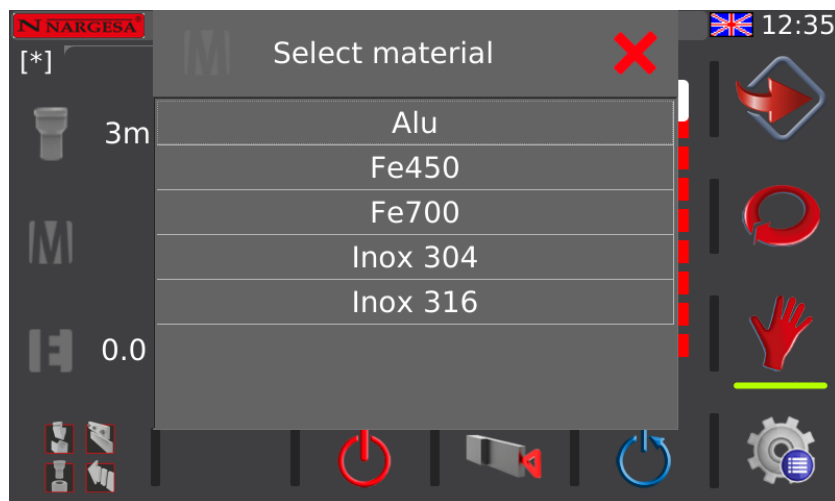

We press the  key to insert the material thickness in millimeters or inches, depending on the settings:

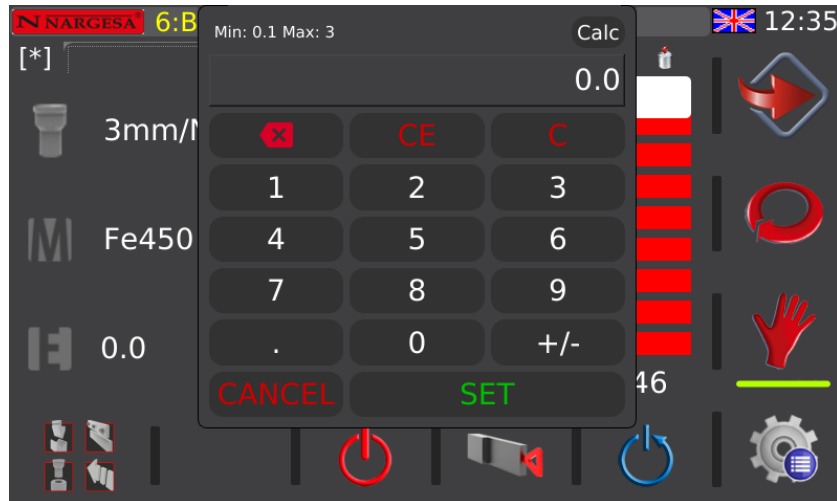

Once we enter the numerical value, we press the **SET** key to validate.

To the right of the **P** icon is the value of power required for punching. This value does not usually need to be changed. However, it can be done to reduce or increase the power you wish to use for work operations.

Finally, we will use the progress bar or the numerical field that is located at the bottom of it to regulate the end of the stroke of the punch.

Note: *It is important to regulate the stroke of the piston so that it doesn't go further than what it should, unnecessarily increasing the time of each punch.*



Once we complete these parameters, we press the button  to start the machine. We will introduce the material in the punching area and press the pedal to carry out the operation.

If you look at the vertical menu at the right side of the screen, you'll see the  icon is selected. This indicates you're in "Manual operating mode" mode; in other words, the piston is moved forward with the forward pedal but you need to switch pedals and press the reverse pedal in order to reverse the piston.

You can switch to "Automatic operating mode" by pressing the  icon. In this mode, reversing the piston does not require operator intervention; therefore, it does not require alternating between the two physical pedals on the machine to do the work.

It is important to remember that we can alternate between these sub-modes whenever necessary just by pressing the corresponding icon.

7. FOLDING

When accessing the Folding function, this screen shows up:



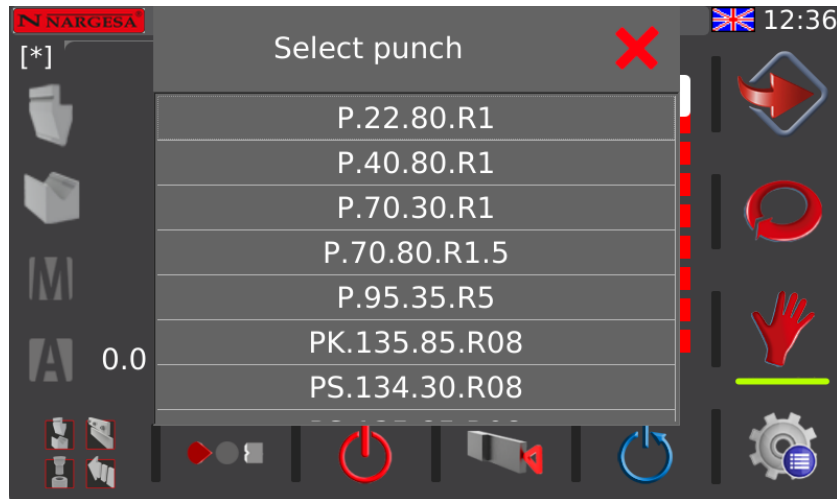

To perform the bending function we must enter the following parameters in the CNC.

We'll press the  to select the punch from the library:

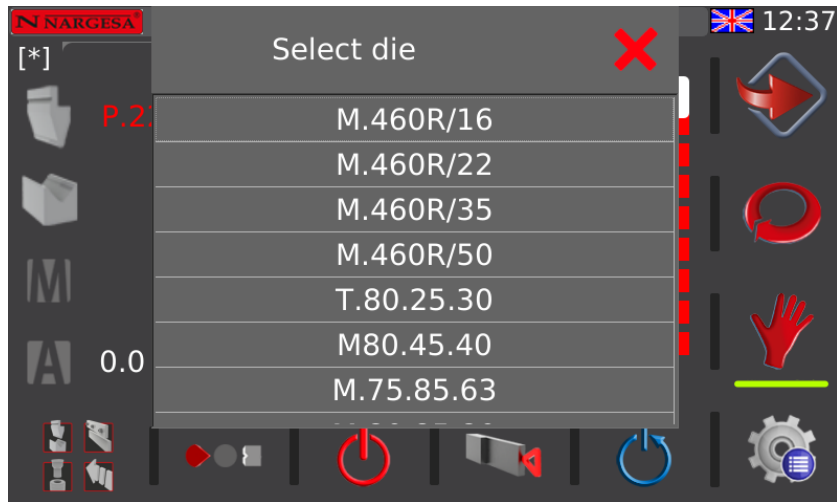

We press the key  to select the die from the library:



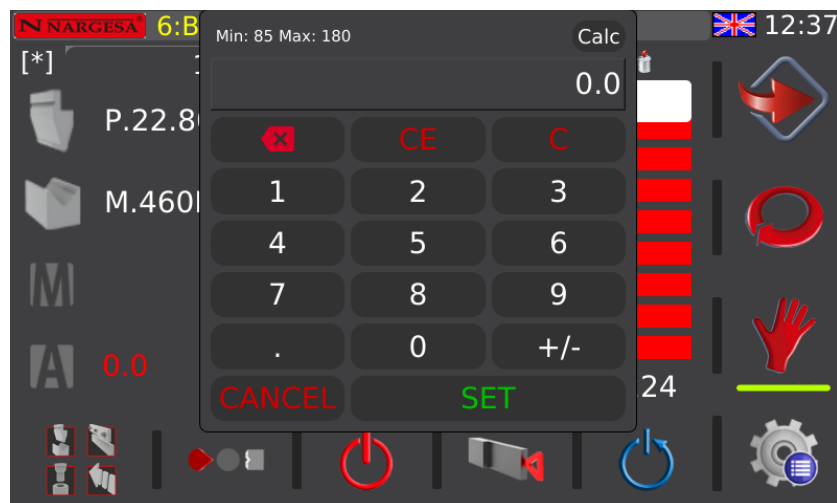

We press the key  to indicate the folding angle:



Once we enter the numerical value, we press the **SET** key to validate.

Then we indicate the position of the punch by pressing the following image, to indicate that:

 The punch is in position 1

 The punch is in position 2

We press the key **M** to select the material from the library:

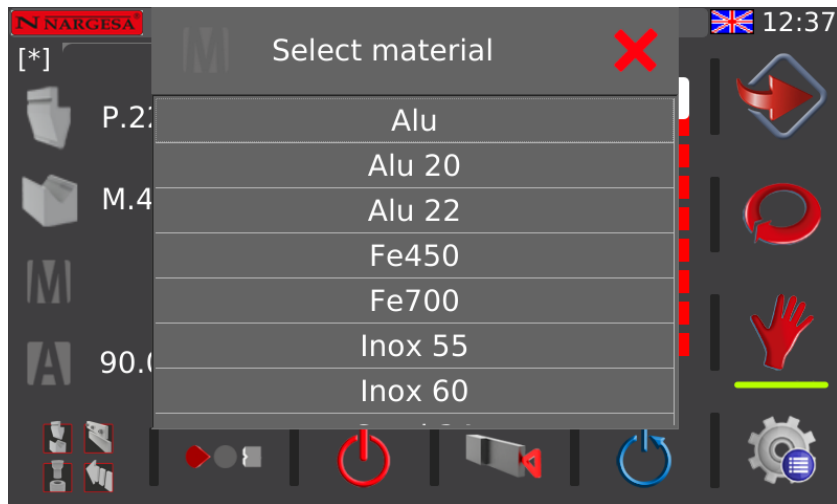

We press the key **E** to introduce the material thickness:

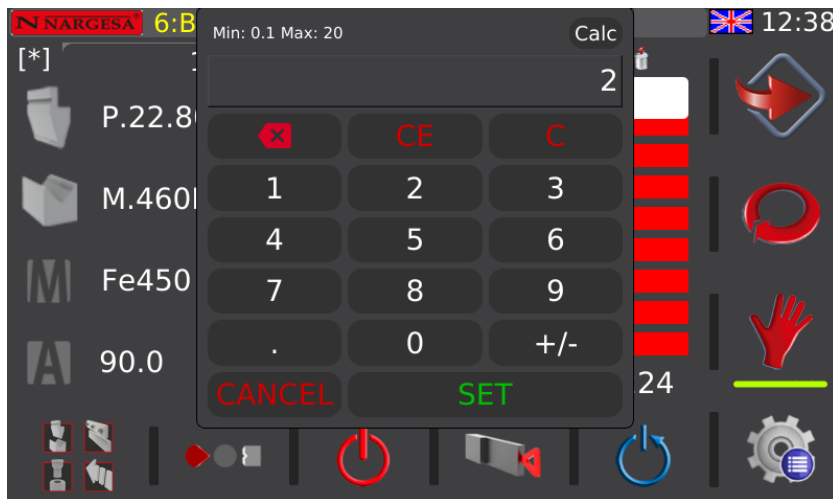

We press the **SET** key to validate the information.

Finally, we will use the progress bar or the numerical field that is located at the bottom of it to regulate the end of the stroke of the punch.



Note: It is important to regulate the stroke of the piston so that it does not go further than needed, unnecessarily increasing the time of each bend.

Once these parameters are completed, we will press the button  to start running the machine.

Introduciremos el material en la zona de plegado y presionaremos el pedal para realizar la operación.

7.1. Folding correction

If we need a correction in the folding angle, we must stop the folding process and indicate the necessary correction. We press the  icon and introduce the number of degrees to correct.

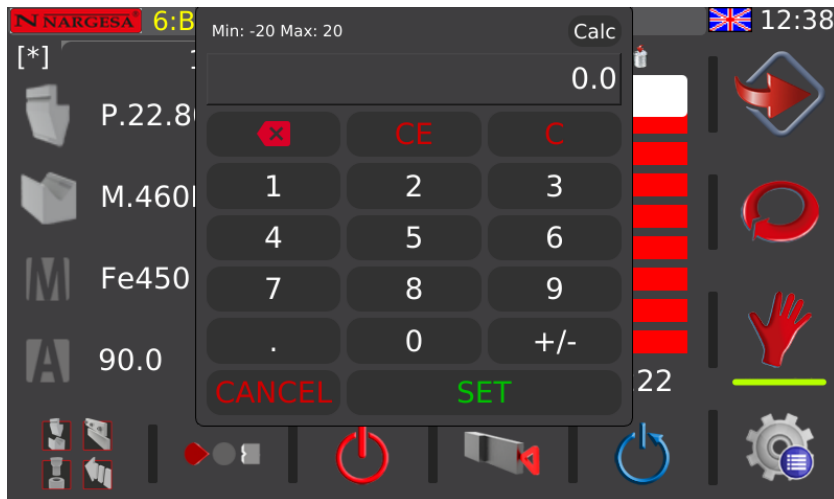

By pressing the **SET** key, we confirm and proceed with another folding.

Automatic Mode and Manual Mode

Up to now, all bending operations have been done in manual mode (the mode indicated on the vertical menu at the right with the  icon). In this mode, the piston is moved forward and backward by pressing the corresponding pedals which means the operator must do an action to forward or reverse it.

However, when creating many parts, it may be uncomfortable to have to constantly switch pedals. If this is the case, you can use the automatic bending mode. To select it, you simply need to press the  icon located to the right of the screen.

Now, after finishing each bend, look at how the piston automatically reverses to the position indicated along the vertical bar. Upon pressing the bend pedal again, the piston will move forward and backward again after finishing the operation. Thus, the operator does not need to constantly switch pedals which speeds up and simplifies the work.

8. SHEARING

When accessing the function SHEARING, this screen shows up:

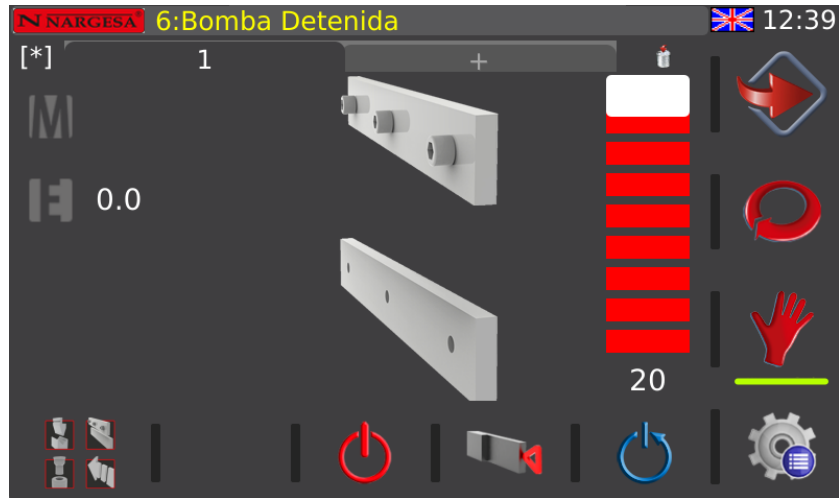

To carry out the Shearing function, we must enter the following parameters in the CNC.

Press the **M** key to select the material:

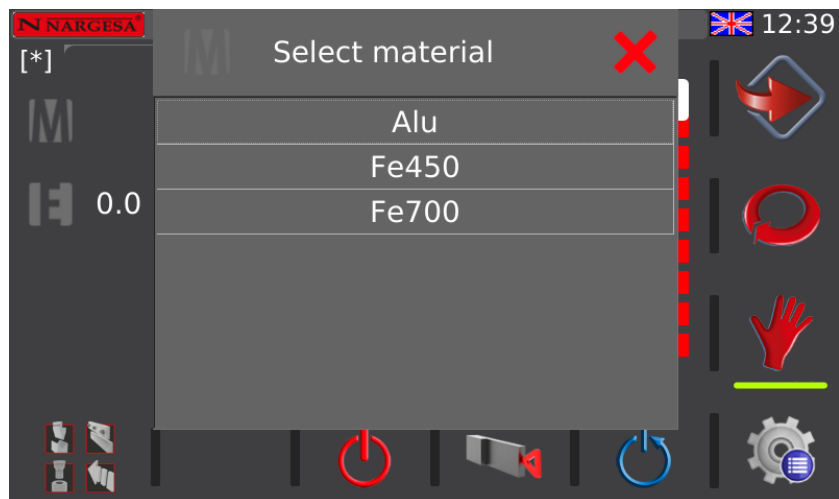

Press the **E** key to insert the material thickness in millimeters or inches depending on the settings:

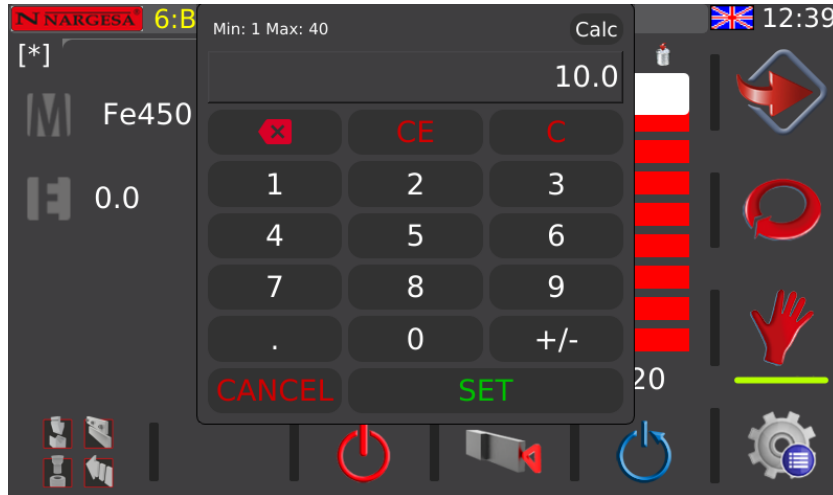

Once we introduce the numerical value, we press the **SET** key to validate it.

Finally, we will use the progress bar or the numerical field at the bottom of it to regulate the end of the blade.

Note: *It is important to regulate the stroke of the piston so that it does not go further than what it requires, unnecessarily increasing the time of each cut.*



Once we complete these parameters, we press the  button to start running the machine.

We introduce the material in the cutting area and press the pedal to make the operation

Remember that when doing the cutting operation, the sub-modes are the same as already explained for bending. These sub-modes are “Manual” and “Automatic” and they work in the same way. Manual mode requires the forward pedal and reverse pedal to operate. And automatic mode does not require any reverse pedal as such action is done autonomously at the end of each operation.

9. MANUAL POSITIONING MODE

Upon accessing “Manual positioning mode”, this screen appears:

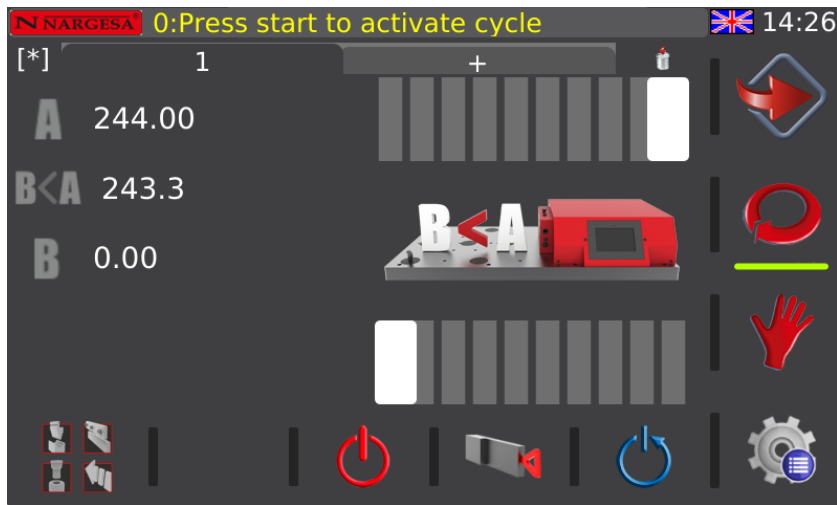

To carry out any function in Manual Mode, we must enter the following parameters in the CNC.

We press the **A** key to introduce the starting dimension of the piston:

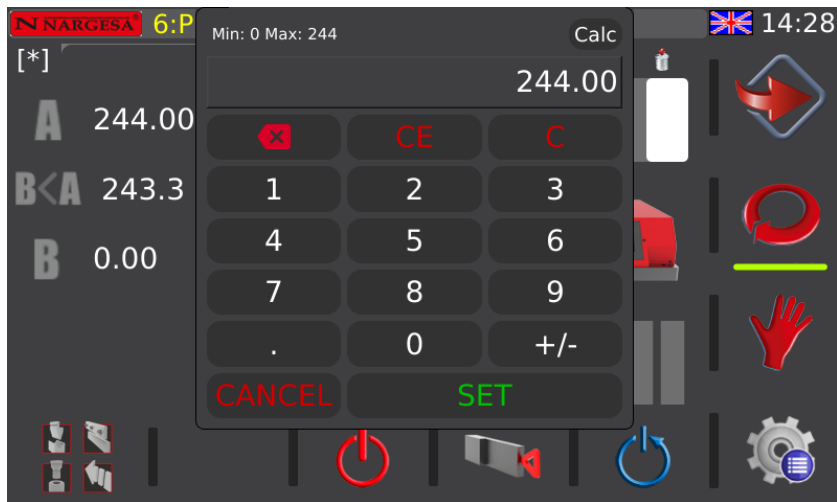

After we have introduced the numerical value, we press the **SET** key to confirm

Press the **B** key to introduce the final piston dimension:

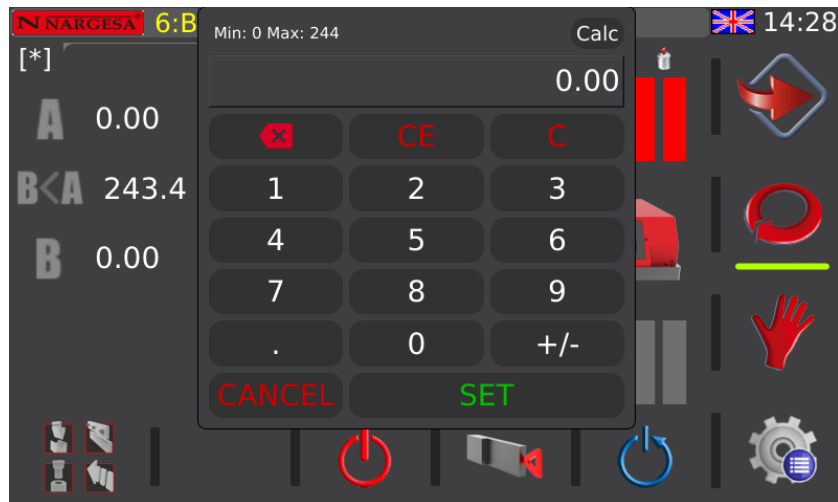

Once we have introduced the numerical value, we press the **SET** key to validate.

In the same way, we can regulate these two dimensions with the progress bars.

Note: It is important to regulate the piston stroke so that it does not go further than what it's required, unnecessarily increasing the time of each operation.

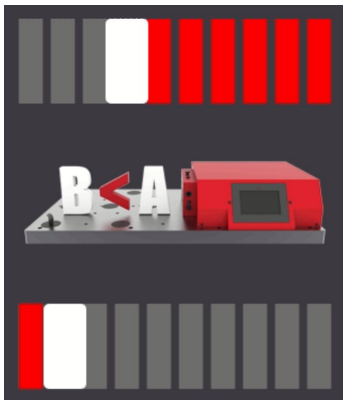

Once these parameters are completed, we will press the  button to start running the machine.

We introduce the material in the working area and we press the pedal to make the operation.

Just like with the other modes (punching, bending and cutting), you can work with a manual or automatic sub-mode which eases and speeds up the operator's work managing the machine when required

10. SAVING PROGRAMS

Now we're going to explain the following screen area (to the top):



The aim of this area is to allow multiple punching, bending, cutting or operations in Manual mode.

So, you should then use the program step bar. This way, you can add new bends to a single piece. So, in line with the example given (one part with two bends), you must press the tab with the “+” symbol after having completed all the data mentioned to operate.

Upon doing that, you'll see how a new step is added with the same data as before except the angle and angle correction. With this new step, you only have to enter the degrees of the following folding.

At this point, you can continue creating new bends for the same part or you can do the bending operations already. It's important to note that if you change any data other than the angle or angle correction in any of the steps, that change will be made to all steps; in other words, it will be considered general program data.

It's now time to physically produce your part. To do so, follow the same steps as explained previously. The only difference you'll see is that after completing each bend, the software will automatically move to the next bend. This way, you can produce your part (with two bends) very easily.

Now, you may need to produce a new part. So, what happens with the data already on screen? Are they lost?

The answer is no as you can save all the data to produce your part, later upload it and continue making the same type of parts. To do so, just press the “[*]” text that appears at the top left of the screen.

When you do so, a screen will appear to insert the name under which you want to save this program. Using a descriptive name is recommended as it will be easier later on to know what features are included in each of the programs saved.

After you do this, the “[*]” text will change to the program name entered. It’s important to remember at this point that it’s still possible to change the data for your program. If you do so, an asterisk will appear after the program name to remind you that your program again has data not yet saved. To save it, just press the program name again.

At this point, it’s time to talk about program management. In other words, until now, you’ve only saved your program. But what about creating a new program? Or how to upload a previous one?



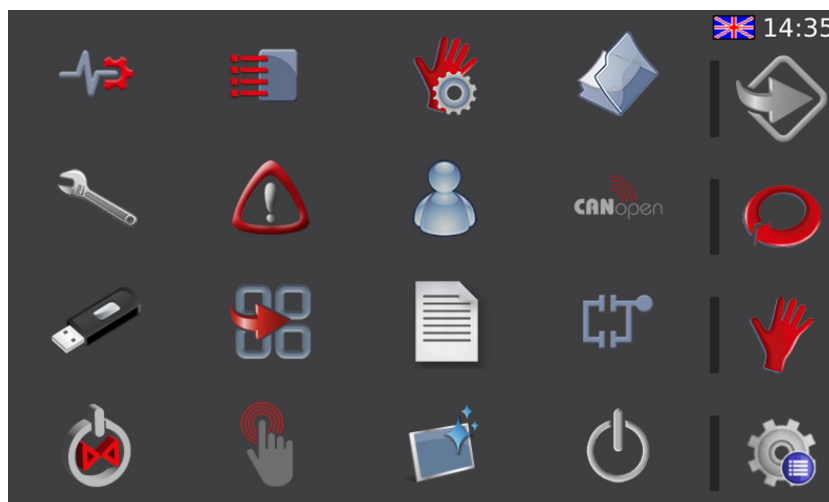

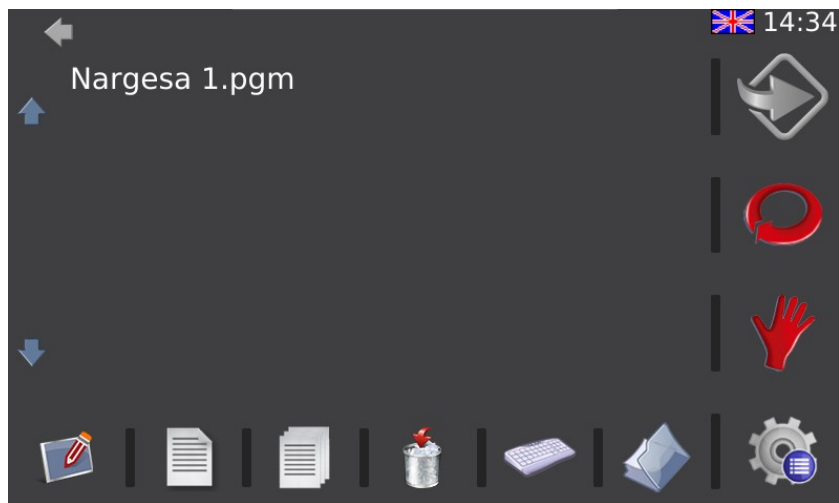
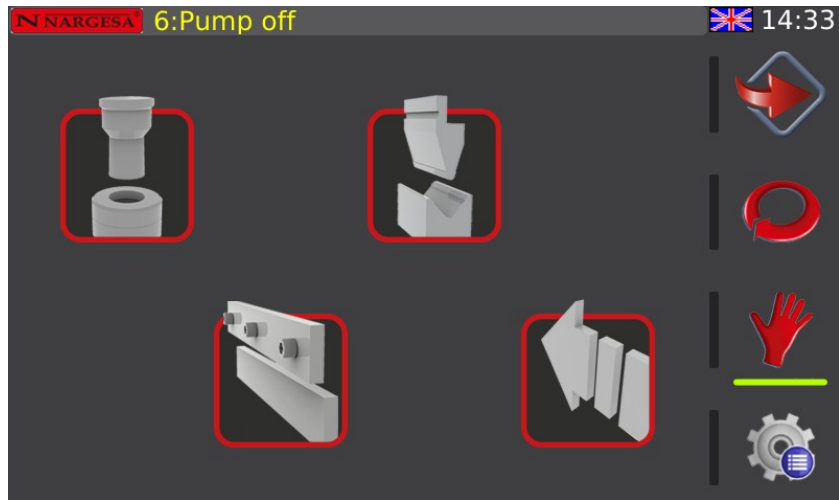

Press the  icon in the menu at the bottom right of the screen. This icon gives you access to the next screen.



We click on the following icon  now and it allows us to access the program management screen of the technology that we want to use in this folding operation:



You can do the following operations using this interface:

- | | |
|--|--|
|  New program |  Rename a program |
|  Upload or edit a program |  Delete a program |
|  Copy a program |  Folder mode |

The operations you can do only require the operator press the corresponding icon. We must mention how “Folder mode” works though.

This mode allows you to do the same operations using the same icons already mentioned yet this time from folders saved on the digital control internal hard drive. This is an advanced operation which is rarely used. But, if you’re able to take advantage of this feature, you can organize programs in a very customized manner.

NOTE: This process can be carried out for all four technologies



11. MENU

11.1. Remote assistance

The Press is prepared to connect to Ethernet through the cable supplied for this purpose. Within the local area network, your IP address is 10.10.51.110, and is already set at the factory. Moreover, this opens up the possibility of allowing remote servicing of the machine.

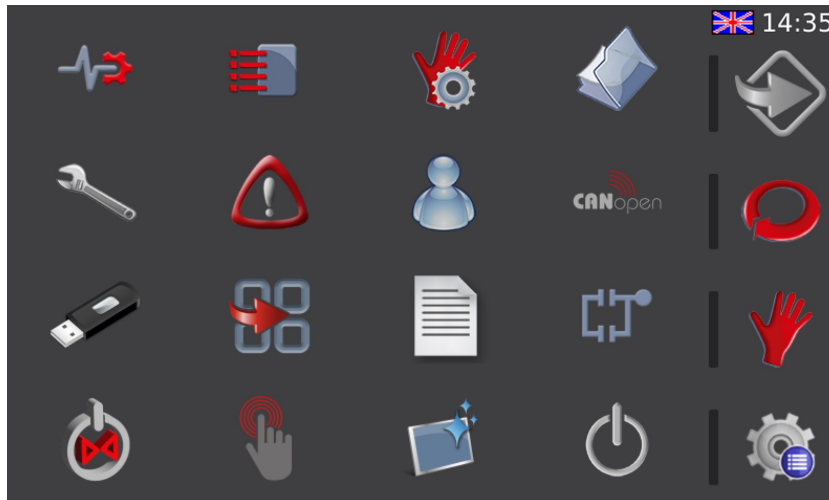
This service allows Nargesa, as the manufacturer of the Press, to connect remotely to the machine to solve technical incidents and carry out remote training for the end user.



To enable the remote service, press the  key to access the menus window and then the  icon.

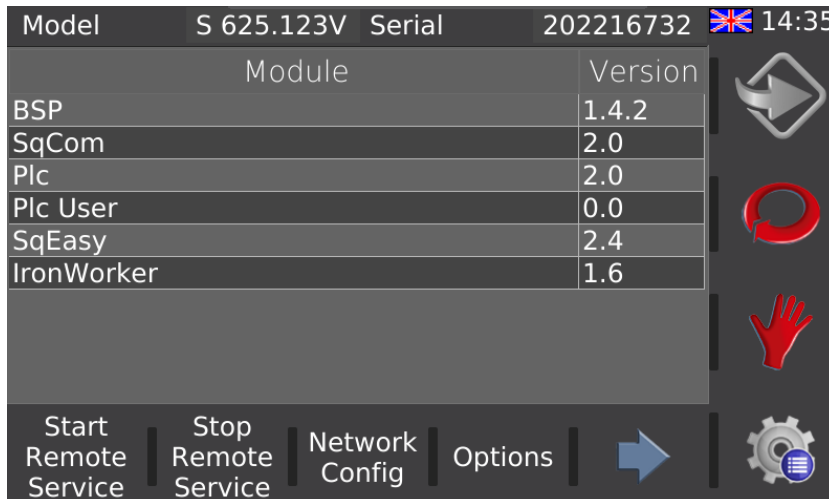



The information shown in the previous picture refers to the model and serial number of the Press control, as well as the versions of the different computer libraries used in the user's interface.

To activate the remote service, so that the Nargesa technical assistance department can connect to the machine to solve out incidents and/or carry out remote training, we must press the **START REMOTE SERVICE** key. However, this mode is already enabled by default on all our machines.

11.2. Importing/exporting parameters, materials and programs

All Press setup parameters, as well as defined materials and created programs, can be imported and exported for backup purposes.





To access the window shown in the previous picture, we must press the key. Once we accede the menu, we must press the  key. When we are in the menus screen, we must press the key .

By default, all filters are activated, as well as the internal memory option. So if we press the  key now, all parameters, materials and tools will be save in the internal memory of the control of the bending Horizontal press brake, making a backup copy. Besides, if we want to make a backup copy on a removable item such as an external USB device, we just have to check the USB option and press again.

It is important to make backup copies frequently to have a backup of the parameters, material and tools created. If at any time it is necessary to recover all or part of this information, we only have to select the origin of the data (internal memory or external USB)

11.3. Touch screen calibration

The touch screen leaves the factory correctly calibrated for its use. However, it may be necessary to calibrate it if the user notes that it does not respond accurately to the actions he commands.

To proceed properly, you must first press the  key to accede the menus window. Once here, you must press the  key. When you do it, the screen displays the message we show below:

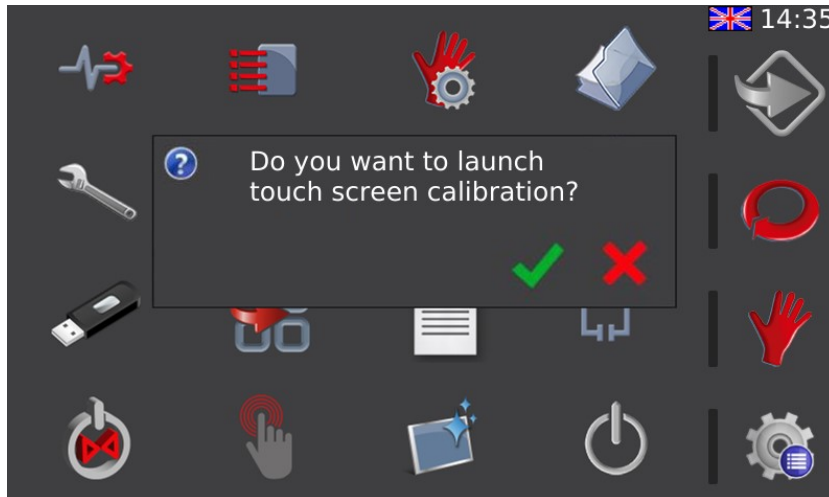

If we accept, pressing on  it starts the calibration process on the touch screen. It is then when the information showed on screen changes into this other one:

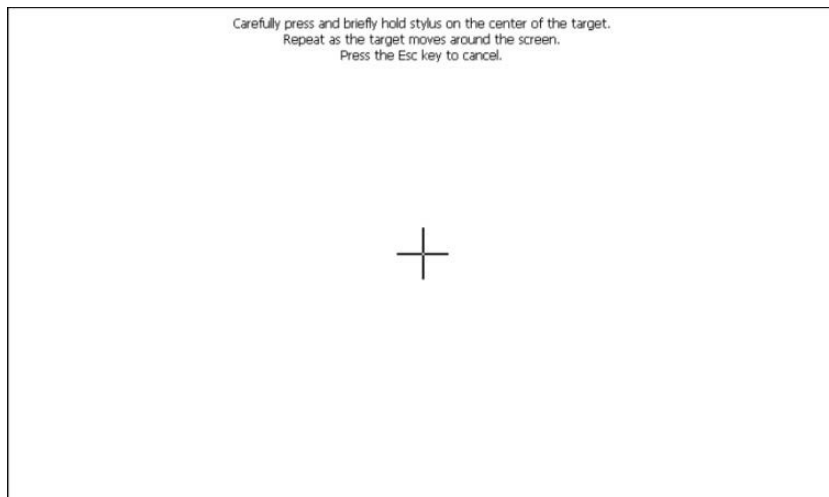

In the center of the window appears a cross that the user has to press for a few seconds until it find itself in a new position. The user should repeat this process at different points on the screen until the touch calibration is finished.

11.4 Tool Management

The flat press is supplied with a complete library of all the tools you can work with. However, at times, the user may need a specific tool for a specific job that isn't in the original library. Under these circumstances, contact us so we can manufacture that tool or you can create it yourself.

However you do it, the question is now how do you tell the software you're using this new tool? The answer is by creating your new tool and adding it to the already existing library.

To do so, you must press the  icon in the general menu. The following screen will appear upon doing this:

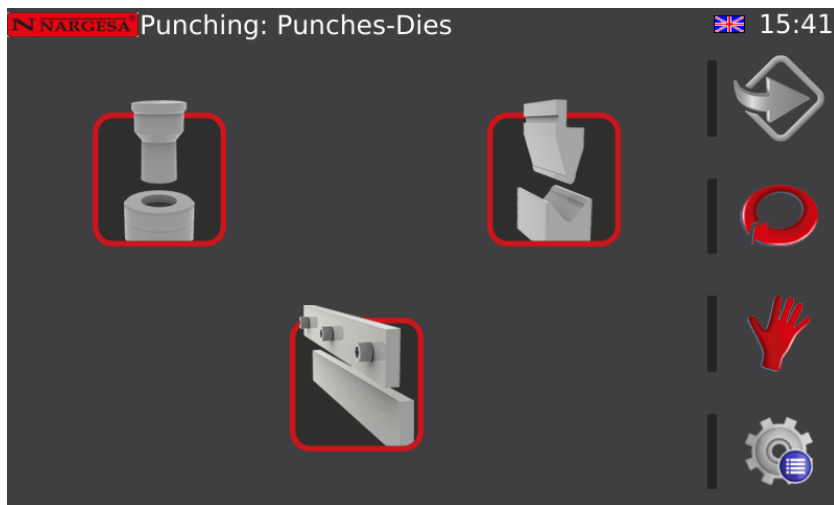

Using this interface, select the type of tool; in other words, if the tool is to be used for punching, bending or cutting. The icons and features are shown below:



Punching tolos



Bending tolos





Cutting tools

11.4.1 Punching Tools

Upon accessing the punching tool screen, you'll see the following interface which corresponds to the materials defined for this work mode.

The following operations are possible if you press the icons in the horizontal menu at the bottom of the screen:



-  Create new material
-  Edit existing material
-  Delete existing material

It's necessary to mention at this point that upon creating or editing material, you'll see the following screen. Here you must enter all the data shown below, which physically define the characteristics of the material.





Name	<input type="text"/>
Hardness	<input type="text"/>
Min Thick	<input type="text"/>
Max Thick	<input type="text"/>

✓
✗

Now, you're going to create the actual tool. To do so, press the  icon at the right of the horizontal menu on the bottom. Having done this, the punch-die window appears for punching.

NARGESA Punching: Punches-Dies 🇬🇧 15:42

Name	Len	Per	Pen	T	Shape	Pos
3m...	58.00	9.42	1.00	3.0	Circle	100
3...	58.00	10.99	1.00	3.5	Circle	99
4m...	58.00	12.56	1.00	4.0	Circle	98
4...	58.00	14.13	1.00	4.5	Circle	97
4X4...	58.00	16.00	1.00	4.0	Squa...	96
5m...	58.00	15.70	1.00	5.0	Circle	94
5...	58.00	17.27	1.00	5.5	Circle	93
5X5...	58.00	20.00	1.00	5.0	Squa...	92
6m...	58.00	18.84	1.00	6.0	Circle	91
6...	58.00	20.42	1.00	6.5	Circle	90

Bottom icons:  |  |  |  | 

Just like with the material management screen, the bottom icons are the ones used to do the operations. In any case, the features of each one of the icons in the bottom menu will not be repeated here as they always do the same actions (new part, part edition, part deletion, etc.).

To create or edit a tool, you must enter the following data defining the real situation. An example is provided below showing the data for an already-existing tool. However, you must enter the actual data defining it if you want to create a new tool.

Name	<input type="text"/>
Punch Length	<input type="text"/>
Perimeter	<input type="text"/>
Penetration	<input type="text"/>
Max thickness	<input type="text"/>
Shape	Circle
Position	<input type="text" value="0"/>

✓
✗

11.4.2 Bending Tools

Just as occurred with the punching tools, upon accessing the bending tool screen, the first thing you'll see are the materials defined for this work mode. If necessary, you can create, edit or delete materials using this interface. These operations (as explained above) are done using the icons in the horizontal menu at the bottom.

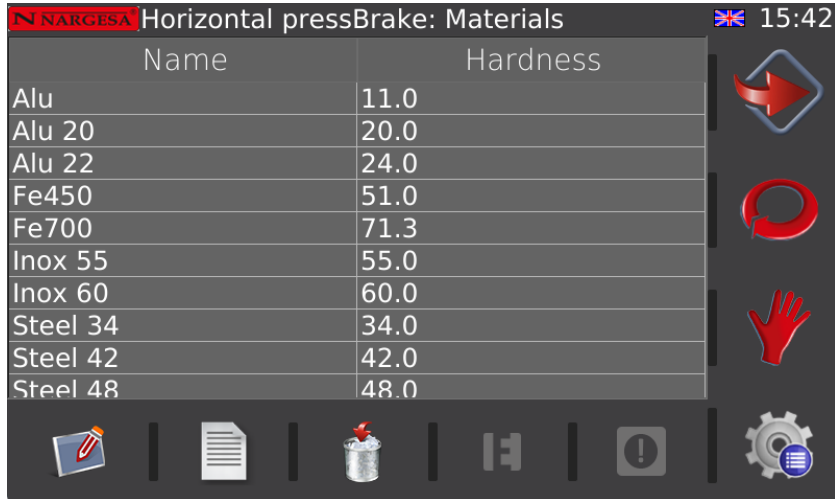

Given that the bending feature is the most complicated of the operations that can be done using the flat press, note that the materials are even more important here. In other words, after defining the material, you can define certain corrections for certain thicknesses and angles to finish correcting the machine behavior during the bending process. This is done by pressing the  icon in the bottom menu.

The following screen will appear upon doing this:

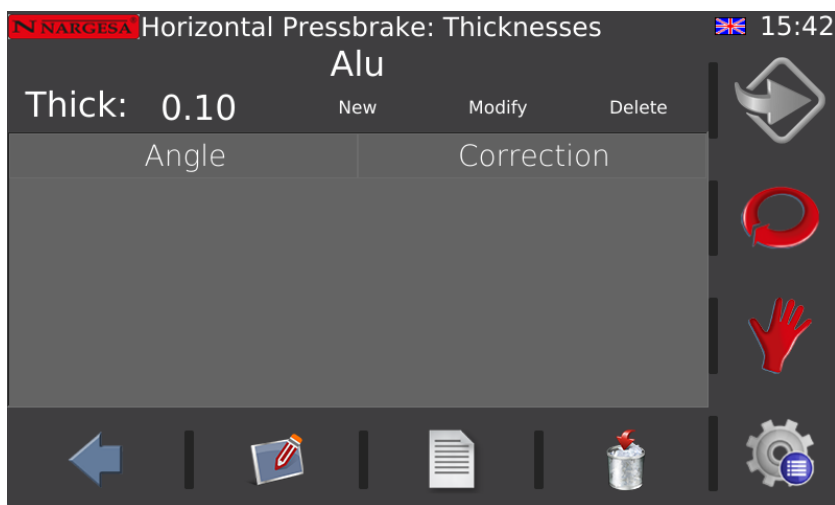

Once inside this window, you can create, change or delete thicknesses by pressing the text on the horizontal line at the height of the thickness.







Plus, you can define a correction for each angle for each thickness. This means these corrections will be applied generally when choosing a specific thickness and angle for the bending feature.

This explanation can seem difficult to understand, but it's an advanced feature that allows you to correct the behavior of the bending process without needing to enter the same corrections again and again for the same angles.

As always, creating, editing and deleting corrections is done using the icons in the menu at the bottom.

To exit this mode and return to the materials screen, just press the  icon also found in the horizontal menu at the bottom.

Again on the materials screen, press the  icon in the menu at the bottom to access the bending punches. The window that appears is as follows:

NARGESA Horizontal pressBrake: Punches							UK 15:43
Name	H	Ang	Rad	Pr	Type	Pos	
P...	45.00	80.0	0.80	20.0	Defa...	35	
P...	55.00	80.0	0.80	40.0	Defa...	35	
P...	70.00	30.0	0.80	50.0	Defa...	35	
P...	68.50	80.0	0.80	100.0	Defa...	35	
P...	65.00	35.0	5.00	100.0	Pro...	35	
PK...	105.00	85.0	0.80	60.0	Pro...	35	
PS...	104.00	30.0	0.80	70.0	Pro...	35	
PS...	105.00	85.0	0.80	100.0	Pro...	35	
PU...	71.73	90.0	3.00	80.0	Pro...	34	
PU...	72.81	90.0	3.50	80.0	Pro...	33	

Following the same process, you can create, change and delete punches. The data physically defining a punch is shown below. Remember that this data is for a punch that exists in the library. If you need to create a new tool, you must enter the data defining the real situation.

Name	
Height	
Angle	
Radius	
Pressure	
Type	Default
Position	

✓
✗

Having reached this point and to sum up, you access the materials screen upon entering and you can manage the bending punches by pressing the icon.



If you press the same icon  again, you'll access the die management screen:

N NARGESA Horizontal pressBrake: Dies 🇬🇧 15:43

Name	H	W	Ang	L	Rad	Pos
M...	60.00	60.00	85.0	16.00	2.00	100
M...	60.00	60.00	85.0	22.00	2.00	100
M...	60.00	60.00	85.0	35.00	2.00	100
M...	60.00	60.00	85.0	50.00	3.00	100
T...	80.00	60.00	30.0	25.00	2.00	99
M80...	80.00	60.00	45.0	40.00	4.00	98
M...	75.00	60.00	85.0	63.00	6.00	0
M...	80.00	60.00	85.0	80.00	6.00	0
M...	95.00	60.00	80.0	100.00	8.00	0
MK1...	103.00	154.00	80.0	125.00	15.00	0





Just like always, the menu at the bottom is where you can manage the tasks (creation, edition and deletion). The data physically defining a die is as follows:

Name	
Height	
Width	
Angle	
L	
Radius	
Position	

✓
✗





Again, if you need to create your own tool, in this case a die, enter the correct data defining that task in the actual situation and not the values shown here.





11.4.3 Cutting Tools

Upon accessing the cutting tools screen, you'll see the following:

N NARGESA Shear: Materials 🇬🇧 15:44

Name	Hardness	Min Thick	Max Thick
Alu	10.0	1.0	10.0
Fe450	50.0	1.0	40.0
Fe700	70.0	1.0	60.0







To be more exact, you could say no tool in particular is defined for the cutting mode. You just define the characteristics defining the specific materials you're using. In the end, this data defines the cutting behavior and not anything others.

So, you create, edit and delete materials again using the icons that appear in the menu at the bottom of the window.

The physical data defining a material is as follows:

Name	<input type="text"/>
Hardness	<input type="text"/>
Min Thick	<input type="text"/>
Max Thick	<input type="text"/>

As always, the data shown as the example corresponds to material that already exists in the library supplied with the machine. If you need to create new materials, you must enter the data defining the real situation.

12. ADJUSTMENT OF THE WORKING STRENGTH

The Horizontal Press Brake NARGESA PP200CNC supplies 20,000Kg of strength.

This amount of power may be excessive depending on the type of work to be carried out. The PP200CNC incorporates a pressure regulatory system to allow us to decrease the strength of the machine.



Figure 12. Elements for the regulation of strength

To decrease the strength of the PP200CNC follow the procedure described below:

1. Place a resistant object over the headstock to act as a buffer.
2. Loosen the screw which blocks the pressure regulator.
3. Press the pedal so that the PP200CNC buffers the resistant object.
4. When buffered turn the pressure regulator towards the minus **—** symbol. The pressure gauge, situated to its right, will indicate a decrease in pressure value. When the ideal pressure is obtained release the pedal.
5. Tighten the screw on the pressure regulator.

Now the PP200CNC is adjusted to use with less strength. Move the headstock back and remove the resistant object.

To increase strength carry out the same procedure moving the pressure indicator to the plus **+** symbol.

NOTE

Remember after decreasing the strength the PP200CNC will not be using its maximum power.

13. FAULT FINDING

13.1. Electrical faults

Due to the daily usage of the Horizontal Press Brake NARGESA PP200CNC faults may arise. The following list of occurrences and their remedies should help you identify and solve most problems.

Problem	Cause	Solution
Indicators lamps do not light up	No electrical supply	Ensure that the machine is connected to the main electrical supply
	Insufficient power	Verify that there is sufficient power
	The breaker switch of the control panel is disactivated	Restart breaker switch on the control panel
	The protection fuse is blown	Replace the fuse
Electric Motor malfunction	The breaker switch of the motor is disactivated	Restart breaker switch of the motor
	Insufficient power	Verify the power input
	Emergency stop button activated	Rotate emergency stop button and restart machine
	Fault in motor guard contactor	Contact technical services

NOTE: In case of repeated problems please contact our technical services at NARGESA.

14. CAUTION

- Do not manipulate any components of the machine while functioning.
- Do not use the machine for any other purpose than those described in this manual.
- Use gloves to manipulate the components of the machine during the process of work.
- Use officially approved protective glasses and boots.
- Firmly hold the material during manipulation.
- Do not work the machine without the protective panels in place.

NARGESA SL does not take responsibility for any accidents caused by the negligence of the operator.

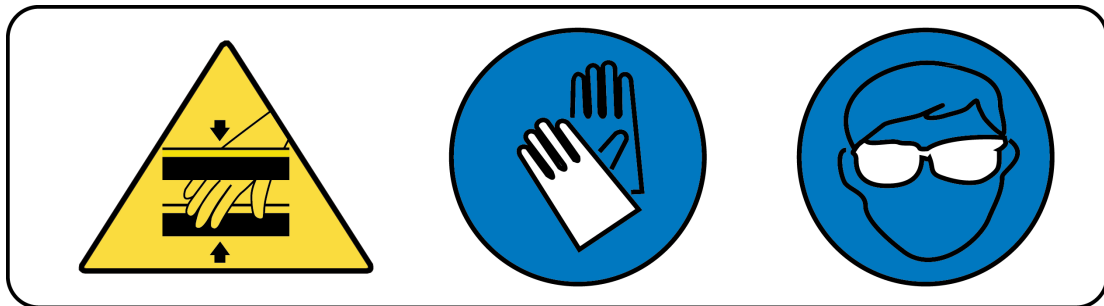

15. TOOLING

PP200CNC Automated Gauge

The automated gauge is an accessory specifically designed to get the most out of the PP200CNC Horizontal Press Brake, offering the possibility to get, automatically, the positioning of the “X” axis for the different operations programmed and calculated with the ESA S625 CNC control, thus improving the performance of operation and quality of work with this machine.

The automated gauge of the PP200CNC enables the user to make single or mass produced parts with top accuracy, speed and repeatability compared to the previous manual system. These are its main features and functions:

- Drive by ESA servomotor and HTD crowned belts that allow automatic positioning of the “X” axis with a precision of $\pm 0.02\text{mm}$.
- Manual adjustment of the cross slide, “Z” axis to cover all the operation possibilities offered by the PP200CNC horizontal press, folding, punching, bending...
- Longitudinal movements of both carriages using high-precision linear guides and recirculating ball runners.
- Automatic anti-collision control managed by the software itself.
- Easy mechanical and electrical installation for quick set up and run.



Reference	140-16-01-50000
Electrical motor	Servomotor 0,9Nm, 0,520kW 5000rpm
Electrical tension	480V, 400V ,220V Three-phase
X axis stroke length	1210 mm
Z axis stroke length	300 mm
Displacement speed	1000mm /s
Positioning accuracy	± 0.02 mm
Repeatability	± 0.02 mm
Maximum structural load	2.000 Kg
Dimensions	1496x1041x426 mm
Weight	115 Kg

Folding die at 161 mm. · V16, 22 35 50 mm. PP200CNC

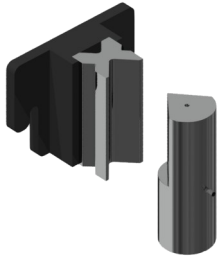

Folding or bending die up to 161mm with 4 openings (16, 22, 35, 50mm) and a punch of 80°. This multi-V die allows 1mm up to 8mm sheet to be folded. The 70mm outer diameter punch allows to make completely closed shapes to a minimum of 75mm inner wing.



Folding punch ref.: 131-16-01-00041 · P.70.80.R1.5

Folding die ref.: 125-16-01-00006

V 16: Sheet from 1 to 3mm · M.460.R/16

V 22: Sheet from 2 to 4mm · M.460.R/22

V 35: Sheet from 3 to 6mm · M.460.R/35

V 50: Sheet from 4 to 8mm · M.460.R/50

Max. Folding length: 161mm

Max. Folding thickness: 8mm

Standard tooling provided along with the machine.

		Ton/m																						
V	H	Ri	E = mm 42 - 48 kg/mm ²																					
			0.5	0.8	1	1.2	1.5	1.8	2	2.5	3	4	5	6	8	10	12	15	20	25				
4	2.6	0.7	4	10.5																				
6	3.9	0.9	2.5	6.5	10																			
8	5.2	1.5	2	5.5	8	11.5	18																	
10	6.5	1.7	4.1	6.5	9.5	14.5	21	26																
12	7.8	2		5.5	8	12	17.5	21.5	33.5															
16	10.4	2.7			6	9	13	16	25	36														
20	13	3.4				7.5	10.5	13	20	29	52													
26	18	4.2					8.5	10.5	16	23	41	64												
30	20	5							14	19	34	54	77											
35	23	6								17	30	46	66											
42	27	6.7								15	26	40	58	103										
45	29	7.5									23	36	52	91										
50	32	8.5										21	32	46	82	128								
60	39	10											27	39	69	107								
70	45	11.7												33	59	92	132							
80	52	13.5													29	52	80	116	180					
90	58	15														46	71	103	160					
100	65	17															41	64	93	144	256			
110	71	18.5																59	84	131	233			
120	78	20																	54	77	120	213		
140	91	24																		66	103	183		
170	110	29																			55	85	151	
200	130	35																				72	128	200



www.narges.com

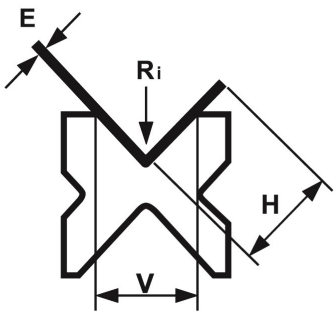

► Baluster forming die 01

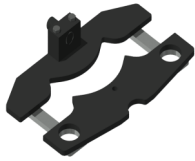

Reference: 140-16-01-00001

Die to form cold forging balusters for grills, gates, fences, handrails, etc... For other shapes or capacities, request the manufacturer.

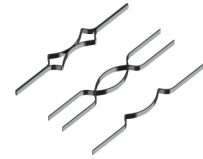

Max. width	Thickness	Die length	Weight
20mm	4, 5, 6, 8 mm	656 mm	21 Kg

► Ring forming

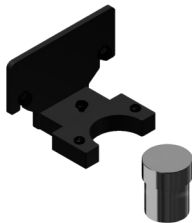

Reference: 140-16-01-00003

Die to form rings or English banister railing, used as ornamental piece in forging railings, gates, fences, etc... for bars bonding. For other sizes and applications consult the manufacturer

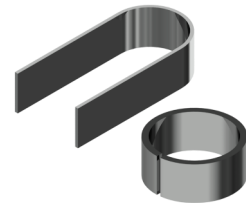

Max. width	Thickness	Outer sizes	Weight
50 mm	6 mm	90 mm	9.3 Kg

► Baluster forming die 04

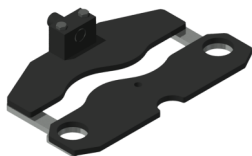

Reference: 140-16-01-00004

Die to form cold forging balusters for grills, gates, fences, handrails, etc... For other shapes or capacities, request the manufacturer.



Square sizes	Die length	Weight
5, 6, 8, 10,12, 14, 16, 18 mm	600 mm	20,5 Kg

► Bending tool for big radius PP200CNC

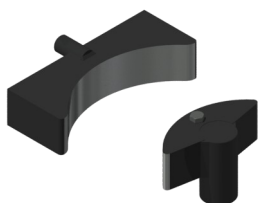

Reference: 140-16-01-00006

Die to form curves in flat bars, pipes, bars or profiles at big radius. It's perfect for bending small series or special parts without requiring a specific custom mold.

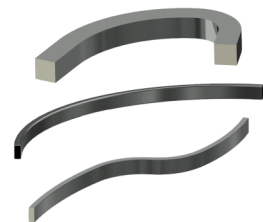

Maximum bar capacity	Maximum pipe capacity	Minimum diameter	Maximum diameter	Weight
40 mm or 1 1/2"	80x80 mm or 3"	300 mm	There is no maximum	35 Kg

► Baluster forming die 08

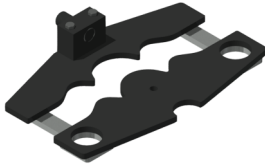

Reference: 140-16-01-00008

Die to form cold forging balusters for grills, gates, fences, handrails, etc... For other shapes or capacities, request the manufacturer.



Max. width	Thickness	Die length	Weight
20 mm	4, 5, 6, 8 mm	650 mm	19,5 Kg

► Baluster forming die 09

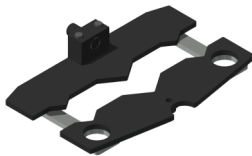

Reference: 140-16-01-00009

Die to form cold forging balusters for grills, gates, fences, handrails, etc... For other shapes or capacities, request the manufacturer.



Flat bar size	Die length	Weight
5, 6, 8, 10,12 mm	522 mm	22 Kg

► Baluster forming die 10



Reference: 140-16-01-00010

Die to form cold forging balusters shaped parts for grills, so called "belly top railing". For other shapes or capacities, please consult the manufacturer.



Flat bar size	Die length	Weight
12 mm	1165 mm	50 Kg

► Baluster forming die 11

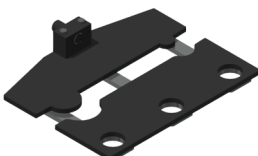

Reference: 140-16-01-00011

Die to form cold forging balusters for grills, gates, fences, handrails, etc... For other shapes or capacities, request the manufacturer.

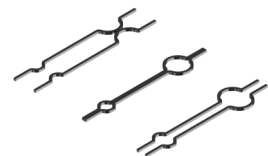

Flat bar size	Die length	Weight
6, 8, 10,12 mm	760 mm	32,5 Kg

► Twisted bars forming die

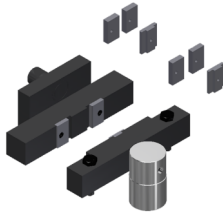

Reference: 140-16-01-00013

Die to bend metal plate, flat bar or square bar to obtain a nice braid twisted effect. It's very used to make fences and grills
For flat bar from to 6, 12 and 14mm. (For different sizes, please ask the manufacturer)

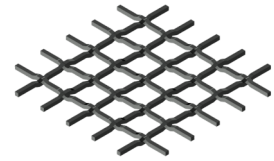

Max. capacity	Min. capacity	Weight
Square 14 mm	2x40 mm metal sheet	18 Kg

► Flat bar cutting tooling 100x10 mm. PP200CNC

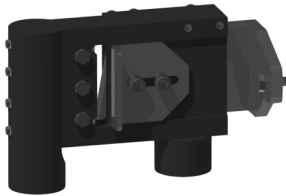

Reference: 140-16-01-00014

Flat bar and metal sheet cutting die up to 100mm through a maximum thickness of 10mm in mild steel.



Max. Cutting length	Max. Cutting thickness	Weight
100 mm	10 mm	23 Kg

► Tool to shape pipe ends PP200CNC

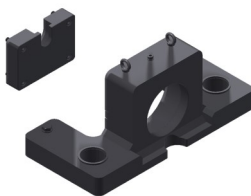

Reference: 140-16-01-00016

Basic die to modify the ends of the tubes for their assembly. You can make all kinds of shapes and flaps according to the customer needs. For special forms consult the manufacturer.

Weight: 110 Kg aprox.

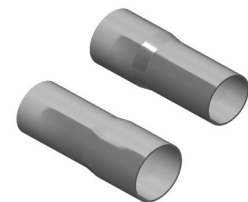

Diameter reduction tools for PP200CNC

Clamp holder to reduce tube PP200CNC

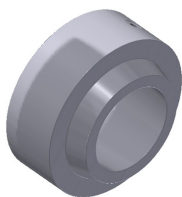

Reference: 140-16-01-RE001

This accessory is adapted to the **Tooling to shape pipe ends**, to perform the operation of reducing the ends of the tubes.

This accessory is used in all tube sizes, that is to say, it is not necessary to buy more than one since it is adaptable to all diameters.

Weight: 12,7 Kg.

Reducing clamp holder PP200CNC



Reference: 140-16-01-RE002

Accessory to set the Reducing Clamps of different diameters.

This accessory is used in all tube sizes, that is to say, it is not necessary to buy more than one since it is adaptable to all diameters.

Weight: 4,6 Kg.

Tube Reducer



This accessory is adapted to the **Tooling to shape pipe ends**, to perform the operation of reducing the ends of the tubes.

It is necessary to buy one specific reducing clamp for each tube according to its initial diameter and the final diameter that we want to achieve.

See the following table of Reducing Clamps:

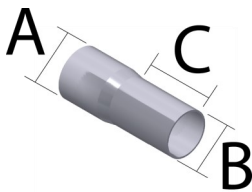

ØA max.	ØB min.	C max.	Reference	Description
16mm	10mm	76mm	140-16-01-RE16-10	Tube Reducer Clamp 16-10 Length Max. 76mm
19mm	13mm	76mm	140-16-01-RE19-13	Tube Reducer Clamp 19-13 Length Max. 76mm
22mm	16mm	76mm	140-16-01-RE22-16	Tube Reducer Clamp 22-16 Length Max. 76mm
25mm	19mm	76mm	140-16-01-RE25-19	Tube Reducer Clamp 25-19 Length Max. 76mm
28mm	22mm	76mm	140-16-01-RE28-22	Tube Reducer Clamp 28-22 Length Max. 76mm
32mm	26mm	76mm	140-16-01-RE32-26	Tube Reducer Clamp 32-26 Length Max. 76mm
35mm	29mm	76mm	140-16-01-RE35-29	Tube Reducer Clamp 35-29 Length Max. 76mm
38mm	32mm	76mm	140-16-01-RE38-32	Tube Reducer Clamp 38-32 Length Max. 76mm
42mm	36mm	76mm	140-16-01-RE42-36	Tube Reducer Clamp 42-36 Length Max. 76mm
45mm	39mm	76mm	140-16-01-RE45-39	Tube Reducer Clamp 45-39 Length Max. 76mm
48mm	42mm	76mm	140-16-01-RE48-42	Tube Reducer Clamp 48-42 Length Max. 76mm
51mm	45mm	76mm	140-16-01-RE51-45	Tube Reducer Clamp 51-45 Length Max. 76mm
54mm	48mm	76mm	140-16-01-RE54-48	Tube Reducer Clamp 54-48 Length Max. 76mm
57mm	51mm	76mm	140-16-01-RE57-51	Tube Reducer Clamp 57-51 Length Max. 76mm
60mm	54mm	76mm	140-16-01-RE60-54	Tube Reducer Clamp 60-54 Length Max. 76mm
63mm	57mm	76mm	140-16-01-RE63-57	Tube Reducer Clamp 63-57 Length Max. 76mm
66mm	60mm	76mm	140-16-01-RE66-60	Tube Reducer Clamp 66-60 Length Max. 76mm
69mm	63mm	76mm	140-16-01-RE69-63	Tube Reducer Clamp 69-63 Length Max. 76mm
73mm	67mm	76mm	140-16-01-RE73-67	Tube Reducer Clamp 73-67 Length Max. 76mm

Diameter expansion tools PP200CNC

Clamp Holder to Expand Tube PP200CNC

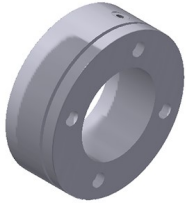

Reference: 140-16-01-EX001

This accessory is adapted to the **Tooling to shape pipe ends**, to perform the operation of expanding the ends of the tubes.

This accessory is used in all tube sizes, that is to say, it is not necessary to buy more than one since it is adaptable to all diameters.

Expansion Mandrel PP200CNC

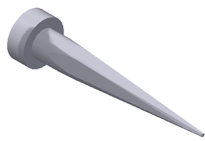

Reference: 140-16-01-EX002

This accessory is adapted to the **Tooling to shape pipe ends**, to perform the operation of expanding the ends of the tubes.

This accessory is used in all tube sizes, that is to say, it is not necessary to buy more than one since it is adaptable to all diameters.

Tube Expander Clamp PP200CNC

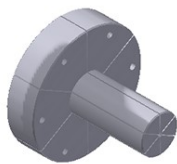

This accessory is adapted to the **Tooling to shape pipe ends**, to perform the operation of expanding the ends of the tubes.

It is necessary to buy one specific expanding clamp for each tube according to its initial diameter and the final diameter that we want to achieve.

See the following table of Expanding Clamps:

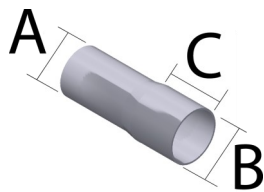

ØA min.	ØB max.	C max.	Reference	Description
22mm	28mm	40mm	140-16-01-EX22-28	Tube Expander Clamp 22-28 Length Max. 40mm
25mm	31mm	40mm	140-16-01-EX25-31	Tube Expander Clamp 25-31 Length Max. 40mm
28mm	34mm	50mm	140-16-01-EX28-34	Tube Expander Clamp 28-34 Length Max. 50mm
31mm	37mm	60mm	140-16-01-EX31-37	Tube Expander Clamp 31-37 Length Max. 60mm
35mm	41mm	60mm	140-16-01-EX35-41	Tube Expander Clamp 35-41 Length Max. 60mm
38mm	44mm	65mm	140-16-01-EX38-44	Tube Expander Clamp 38-44 Length Max. 65mm
41mm	47mm	65mm	140-16-01-EX41-47	Tube Expander Clamp 41-47 Length Max. 65mm
44mm	50mm	80mm	140-16-01-EX44-50	Tube Expander Clamp 44-50 Length Max. 80mm
47mm	53mm	80mm	140-16-01-EX47-53	Tube Expander Clamp 47-53 Length Max. 80mm
51mm	57mm	80mm	140-16-01-EX51-57	Tube Expander Clamp 51-57 Length Max. 80mm
54mm	60mm	80mm	140-16-01-EX54-60	Tube Expander Clamp 54-60 Length Max. 80mm
60mm	66mm	80mm	140-16-01-EX60-66	Tube Expander Clamp 60-66 Length Max. 80mm

► Die to straighten out profiles PP200CNC

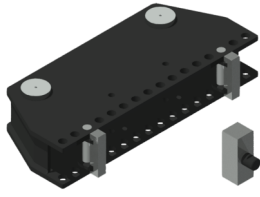

Reference: 140-16-01-00017

Tool used to bend straight profiles or parts. It is adjustable to different capacities according to the

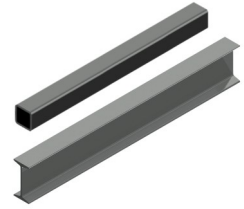

Maximum capacity	Weight
H 150 mm	72 Kg

► Baluster forming die 20

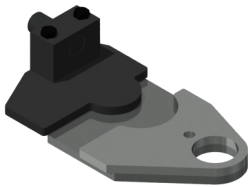

Reference: 140-16-01-00020

Die to form cold forging balusters for grills, gates, fences, handrails, etc... For other shapes or capacities, request the manufacturer.

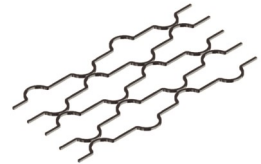

Square sizes	Circumference size	Weight
12x12 mm	90 mm	11 Kg

► Punching die

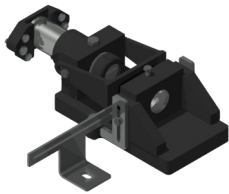

Reference: 140-16-01-00022

Punch-holder die, compatible with our Nargesa brand punches.

Gooseneck: 54 mm

Free distance of tooling: 95 mm

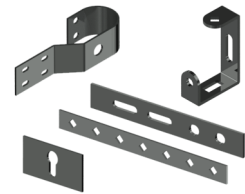

	Round	Square	Rectangular	Oval	Weight
Max. Punching capacity	43 mm	35 mm	20x34 mm	21x40 mm	52 Kg

► Promecam punch holder PP200CNC

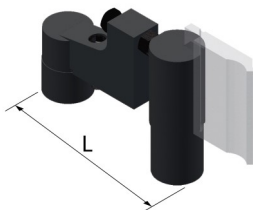

Reference: 140-16-01-00023

Punch holder for all kind of punches for Promecam bending or folding press.

Compatible with any Promecam punch.

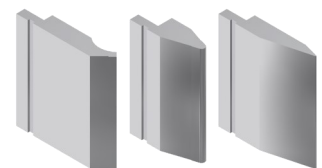

Max. Folding length	L Length	Weight
150 mm	276 mm	14 Kg

▶ **Clamp forming die PP200CNC**

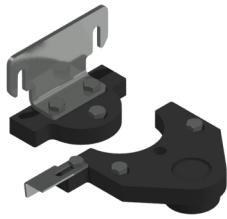

Reference: 140-16-01-00024

Die to form all kinds of clamps. This tooling is manufactured according to the user's needs thus it is required to have a technical drawing or a sample



Maximum capacity

100x4 mm

▶ **Special punches**

Folding punches to bend special pieces of small sizes or folded up to 30°.



Folding Punch D70 30° **P.70.30.R1,5**

REF: 140-16-01-00025

Max. Folding length: 100mm

Punch degrees: 30°

Punch diameter: 70mm



Folding Punch D40 80° **P.40.80.R1**

REF: 140-16-01-00026

Max. Folding length: 60mm

Punch degrees: 80°

Punch diameter: 40mm

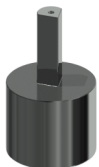

Folding Punch D22 80° **P.22.80.R1**

REF: 140-16-01-00027

Max. Folding length: 60mm

Punch degrees: 80°

Punch diameter: 22mm

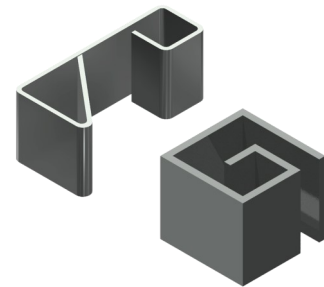

Weight: 3Kg each unit approximately

▶ **Bar clamps forming die**

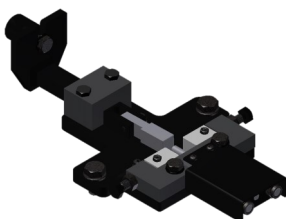

Reference: 140-16-01-00028

Clamp forming die, used to manufacture the clamps used to join different forging bars with no need to get them welded.

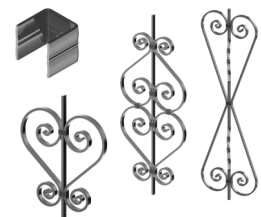

Max. capacity

25x5 mm

Weight

9 Kg

► Forming die adaptor



Reference: 140-16-01-00029

It is an exchangeable fitting device for the forming dies, suitable for each of the different baluster forming tools. It is advisable to get one in order to work with the specified dies.

Weight: 3,1 Kg

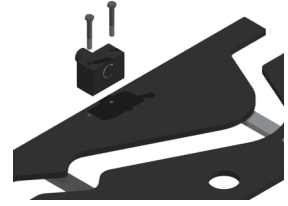

► Punch Promecam PS.135.85.R08

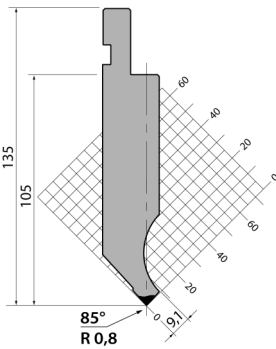

Reference: 140-16-01-00030

Folding length: 161 mm

Weight: 3,2 Kg

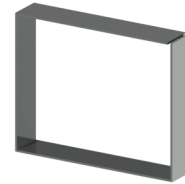

► Punch Promecam P.95.35.R5

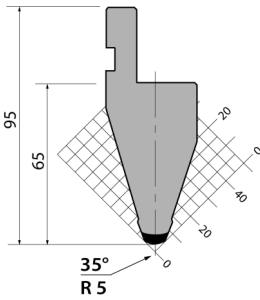

Reference: 140-16-01-00031

Folding length: 161 mm

Weight: 2,3 Kg

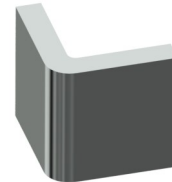

► Punch Promecam PS.134.30.R08

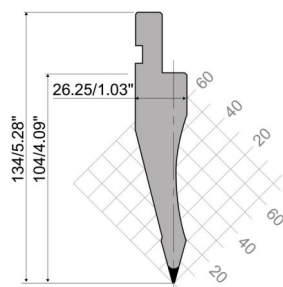

Reference: 140-16-01-00032

Folding length: 161 mm

Weight: 2,7 Kg



► Punch Promecam PK.135.85.R08

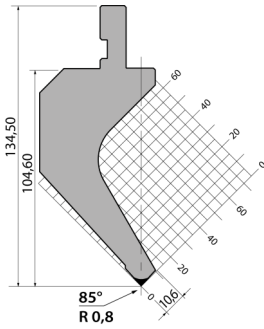

Reference: 140-16-01-00038

Folding length: 161 mm

Weight: 4,4 Kg

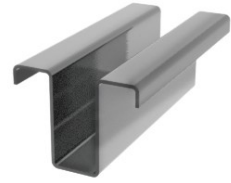

► Folding die T80.25.35



Reference: 140-16-01-00036

Folding length: 161 mm Max. 35°

V25: From 1,5 to 5 mm sheet

Weight: 4 Kg.



► Folding die M80.45.40

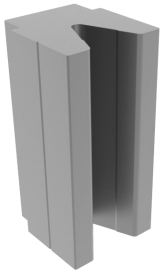

Reference: 140-16-01-00041

Folding length: 161 mm Max. 45°

V40: From 3 to 8 mm sheet

Weight: 6,2 Kg.

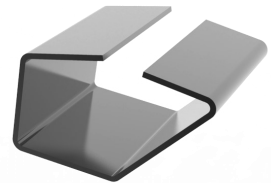

► Folding die M75.85.63



Reference: 140-16-01-00033

Folding length: 161 mm Max. 85°

V63: From 5 to 10 mm sheet

Weight: 5 Kg.

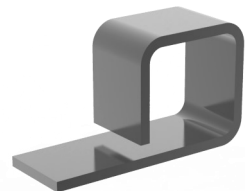

► Folding die M80.85.80



Reference: 140-16-01-00034
Folding length: 161 mm Max. 85°
V80: From 6 to 12 mm sheet
Weight: 6 Kg.

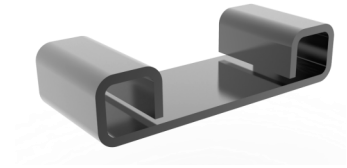

► Folding die M95.80.100

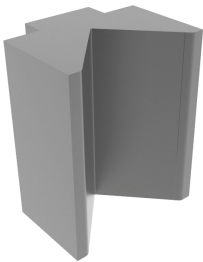

Reference: 140-16-01-00035
Folding length: 161 mm Max. 80°
V100: From 8 to 15 mm sheet
Weight: 9 Kg.

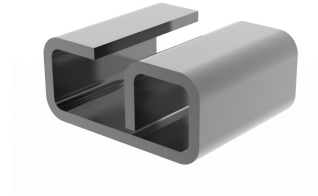

► Folding die MK103.80.125

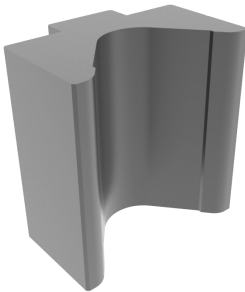

Reference: 140-16-01-00040
Folding length: 161 mm Max. 80°
V125: From 12 to 20 mm sheet
Weight: 12,4 Kg.



Small radii holder PU.67.14-S



Reference: 140-16-01-00042
 European style R1 bending tool holder. (For radii from 3 to 7,5 mm)
Folding length: 161 mm
Weight: 2 Kg.

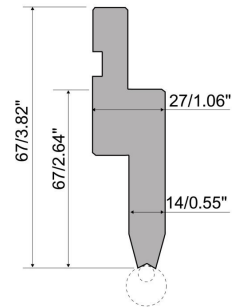

Radius elements for small radii holders PU.67.14-S

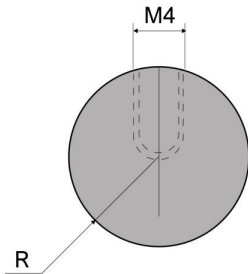

Radius elements to fold. Made of C45, a high quality, medium grade steel, with constant mechanical properties and good external chrome resistance.

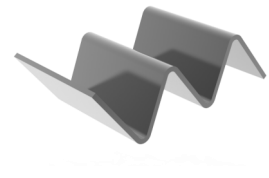

Maximum capacity: 400kN/m.
Tonnage: 400 kN/m max.

For its use it requires the PU.67.14-S Small radius holder.

Please refer to the following radius chart:

Small radius				
Type	Code	Reference	Radius	Weight
C3	PU.67.14-S-C3	140-16-01-00044	3 mm	0,04 Kg
C3.5	PU.67.14-S-C3.5	140-16-01-00045	3,5 mm	0,04 Kg
C4	PU.67.14-S-C4	140-16-01-00046	4 mm	0,07 Kg
C4.5	PU.67.14-S-C4.5	140-16-01-00047	4,5 mm	0,10 Kg
C5	PU.67.14-S-C5	140-16-01-00048	5 mm	0,12 Kg
C5.5	PU.67.14-S-C5.5	140-16-01-00049	5,5 mm	0,14 Kg
C6	PU.67.14-S-C6	140-16-01-00050	6 mm	0,16 Kg
C6.5	PU.67.14-S-C6.5	140-16-01-00051	6,5 mm	0,20 Kg
C7	PU.67.14-S-C7	140-16-01-00052	7 mm	0,16 Kg
C7.5	PU.67.14-S-C7.5	140-16-01-00053	7,5 mm	0,20 Kg

Big radii holder PU.67.14

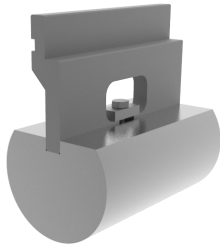

Reference: 140-16-01-00043

European style R1 bending tool holder. (For radii from 8 to 50 mm)

Folding length: 161 mm

Weight: 1,80 Kg.

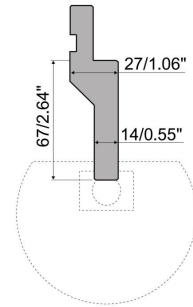

Radius elements for large radii holders PU.67.14

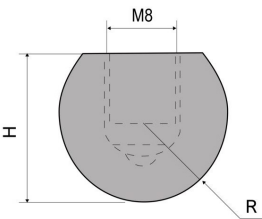

Radius elements to fold. Made of C45, a high quality, medium grade steel, with constant mechanical properties and good external chrome resistance.

Tonnage: 800 kN/m max.

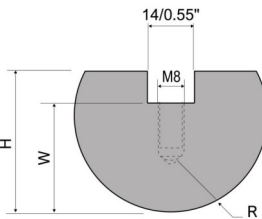
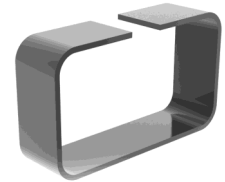

For its use it requires the PU.67.14 large radius holder.

Please refer to the following radius chart:

Big radius					
Code	Reference	R (mm)	H (mm)	A (mm)	Weight
PU.67.14.R8	140-16-01-00054	8	13	-	0,04 Kg
PU.67.14.R9	140-16-01-00055	9	16	-	0,04 Kg
PU.67.14.R10	140-16-01-00056	10	16	-	0,04 Kg
PU.67.14.R12,5	140-16-01-00057	12,5	17	22	0,50 Kg
PU.67.14.R15	140-16-01-00058	15	20	27	0,75 Kg
PU.67.14.R17,5	140-16-01-00059	17,5	22	32	1,00 Kg
PU.67.14.R20	140-16-01-00060	20	24	34	1,40 Kg
PU.67.14.R22,5	140-16-01-00061	22,5	25	35	1,50 Kg
PU.67.14.R25	140-16-01-00062	25	29	39	2,00 Kg
PU.67.14.R27,5	140-16-01-00063	27,5	34	44	2,50 Kg
PU.67.14.R30	140-16-01-00064	30	34	44	2,70 Kg
PU.67.14.R32,5	140-16-01-00065	32,5	37	47	3,20 Kg
PU.67.14.R35	140-16-01-00066	35	45	55	4,10 Kg
PU.67.14.R37,5	140-16-01-00067	37,5	42	52	4,10 Kg
PU.67.14.R40	140-16-01-00068	40	45	55	4,60 Kg
PU.67.14.R45	140-16-01-00069	45	60	70	6,80 Kg
PU.67.14.R50	140-16-01-00070	50	70	80	8,70 Kg

► Punches and dies

► Standard round punches

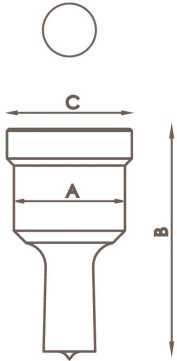

1Type	Available sizes in mm Ø	A	B	C
N28	3/3'5/4/4'5/5/5'5/6/6'5/7/7'5/8/8'5 9mm up to 28mm from 0'5 in 0'5mm	28 mm	58 mm	31,5 mm
N40	29/30/31/32/33/34/35/36/37/38/39/40mm	40 mm	64 mm	43,5 mm
N50	41/42/43mm	50 mm	58 mm	54 mm
<i>For different sizes, please ask the manufacturer.</i>				

► Standard square punches

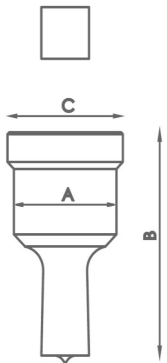

Type	Available sizes in mm Ø	A	B	C
N28	4/5/6/7/8/9/10/11/12/13/14/15/16/17/18/19/20mm	28 mm	58 mm	31,5 mm
N40	21/22/24/26/28mm	40 mm	64 mm	43,5 mm
N50	31/33/35mm	50 mm	58 mm	54 mm
<i>For different sizes, please ask the manufacturer</i>				

► Standard rectangular punches

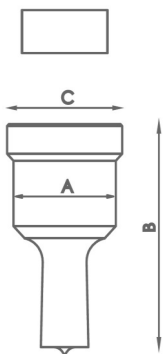

Type	Available sizes in mm Ø	A	B	C
N28	7x10/7x15/9x13/9x19/11x17/11x23 13x19/15x21mm	28 mm	58 mm	31,5 mm
N40	13x25/15x27/17x25/19x30/20x34mm	40 mm	64 mm	43,5 mm
<i>For different sizes, please ask the manufacturer</i>				

► Standard oval punches

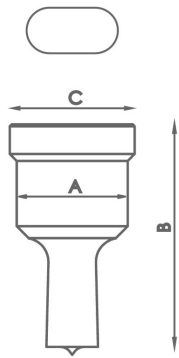

Type	Available sizes in mm Ø	A	B	C
N28	7x10/7x15/7x20/9x13/9x19/11x17/11x23/13x18 13x22/13x27/15x20/15x24/15x27/17x22/17x26 19x26/21x27mm	28 mm	58 mm	31,5 mm
N40	13x31/15x31/17x31/17x40/19x31 19x40/21x31/21x40mm	40 mm	64 mm	43,5 mm
<i>For different sizes, please ask the manufacturer</i>				

► Standard round dies

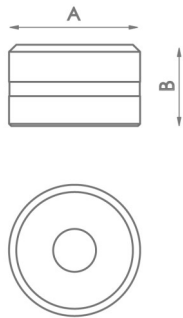

Type	Available sizes in mm	A	B
N46	3/3,5/4/4,5/5/5,5/6/6,5/7/7,5/8/8,5 9mm hasta 28mm from 0,5 in 0,5mm	46 mm	28,5 mm
N60	29/30/31/32/33/34/35/36/37/38/39/40mm	60 mm	32 mm
N78	41/42/43mm	78 mm	28,5 mm
<i>For different sizes, please ask the manufacturers.</i>			

► Standard square dies

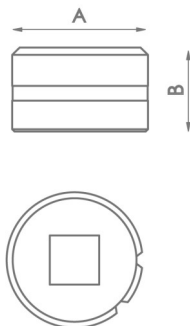

Type	Available sizes in mm	A	B
N46	4/5/6/7/8/9/10/11/12/13/14/15/16/17/18/19/20mm	46 mm	28,5 mm
N60	21/22/24/26/28mm	60 mm	32 mm
N78	31/33/35mm	78 mm	28,5 mm
<i>For different sizes, please ask the manufacturers.</i>			

► **Standard rectangular dies**

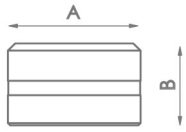

Type	Available sizes in mm	A	B
N46	7x10/7x15/9x13/9x19/11x17/11x23/13x19/13x25/ 15x21mm	46 mm	28,5 mm
N60	15x27/17x25/19x30/20x34mm	60 mm	32 mm

For different sizes, please ask the manufacturers.

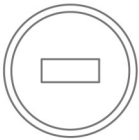

► **Oval dies**



Type	Available sizes in mm	A	B
N46	7x10/7x15/7x20/9x13/9x19/11x17/11x23/13x18/13x22/13x27 15x20/15x24/15x27/17x22/17x26/19x26/21x27mm	46 mm	28,5 mm
N60	13x31/15x31/17x31/17x40/19x31/19x40/21x31/21x40mm	60 mm	32 mm

For different sizes please ask the manufacturer



► **Tube notching tooling**

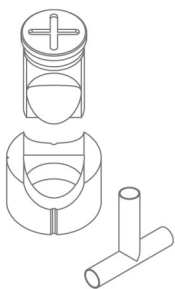

Reference	Available sizes in mm	Required fitting	
MAN28	Tube from 16 to 28mm	TAP 28	CAB 46
MAN40	Tube from 28,5 to 40mm	TAP 40	CAB 60
MAN50	Tube from 40,5 to 50mm	TAP 50	CAB 78

For different sizes please ask the manufacturer

► Flat bar round end tooling R1

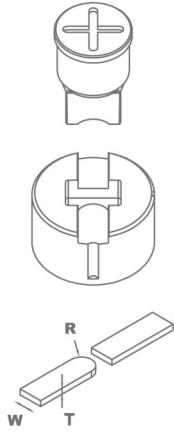

Reference	Model	Width size	Required fitting
MOR1-35A	A	From 20 to 35mm	TAP28 / TAP40
MOR1-35B	B	From 20 to 35mm	TAP28 / TAP40
MOR1-35C	C	From 20 to 35mm	TAP28 / TAP40
MOR1-35D	D	From 20 to 35mm	TAP28 / TAP40
MOR1-50A	A	From 40 to 50mm	TAP50 / TAP60 with ATAP
MOR1-50B	B	From 40 to 50mm	TAP50 / TAP60 with ATAP
MOR1-50C	C	From 40 to 50mm	TAP50 / TAP60 with ATAP
MOR1-50D	D	From 40 to 50mm	TAP50 / TAP60 with ATAP

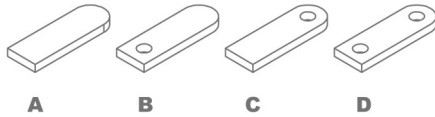

For different sizes, please ask the manufacturer.

When placing order it must be specified the REFFERENCE, MODEL, R (radius), W (flat bar width), T (flat bar thickness)

In models B, C and D specify diemeter of the hole.

The ear shaped legth is always adjustable.

Production capacity: 450 to 600 parts per hour.

► Flat bar round end tooling R2

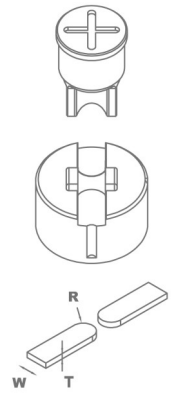

Reference	Model	Width size	Required fitting
MOR2-35A	A	From 20 to 35mm	TAP28 / TAP40
MOR2-35B	B	From 20 to 35mm	TAP28 / TAP40
MOR2-35C	C	From 20 to 35mm	TAP28 / TAP40
MOR2-50A	A	From 40 to 50mm	TAP50 / TAP60 with ATAP
MOR2-50B	B	From 40 to 50mm	TAP50 / TAP60 with ATAP
MOR2-50C	C	From 40 to 50mm	TAP50 / TAP60 with ATAP

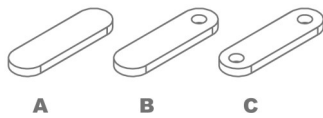

For different sizes, please ask the manufacturer.

When placing order it must be specified the REFFERENCE, MODEL, R (radius), W (flat bar width), T (flat bar thickness)

In models B and C specify hole diameter.

The ear shaped legth is always adjustable.

Production capacity: 450 to 600 parts per hour.

► **Corner rounding tooling**



Reference	Available sizes in mm	Required fitting	
MRE28	Radius from 3 to 16mm	TAP 28	CAB 46
MRE40	Radius from 16,5 to 26mm	TAP 40	CAB 60
MRE50	Radius from 26,5 to 32mm	TAP 50	CAB 78

For different sizes please ask the manufacturer

► **Fitting nuts for punches**



Reference	Type	Fitting nuts for punches
120-02-01-00011	TAP28	Fitting nuts for punches N28
140-02-01-00019	TAP40	Fitting nuts for punches N40
140-02-01-00020	TAP50	Fitting nuts for punches N50
140-02-01-00021	TAP60	Fitting nuts for punches N60

► **Fitting for dies**

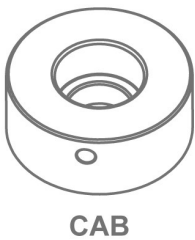

Reference	Type	Fitting for dies
120-02-01-00012	N46	Fitting for dies N46
140-02-01-00024	N60	Fitting for dies N60
140-02-01-00025	N78	Fitting for dies N78

Technical annex

Horizontal Press Brake PP200CNC

List of parts

Piston assembly

Hydraulic group

Control Panel

Electric map · THREEPHASE MACHINE

Electric map · SINGLEPHASE MACHINE

Pedal connection

Hydraulic group

Electrical diagram · TRIFASICA MACHINE

Electrical diagram · SINGLE-PHASE MACHINE

Hydraulic scheme

Technical features - Tooling

Folding die al 161mm

Rong forming die

Twisted bars forming die

A1. List of parts

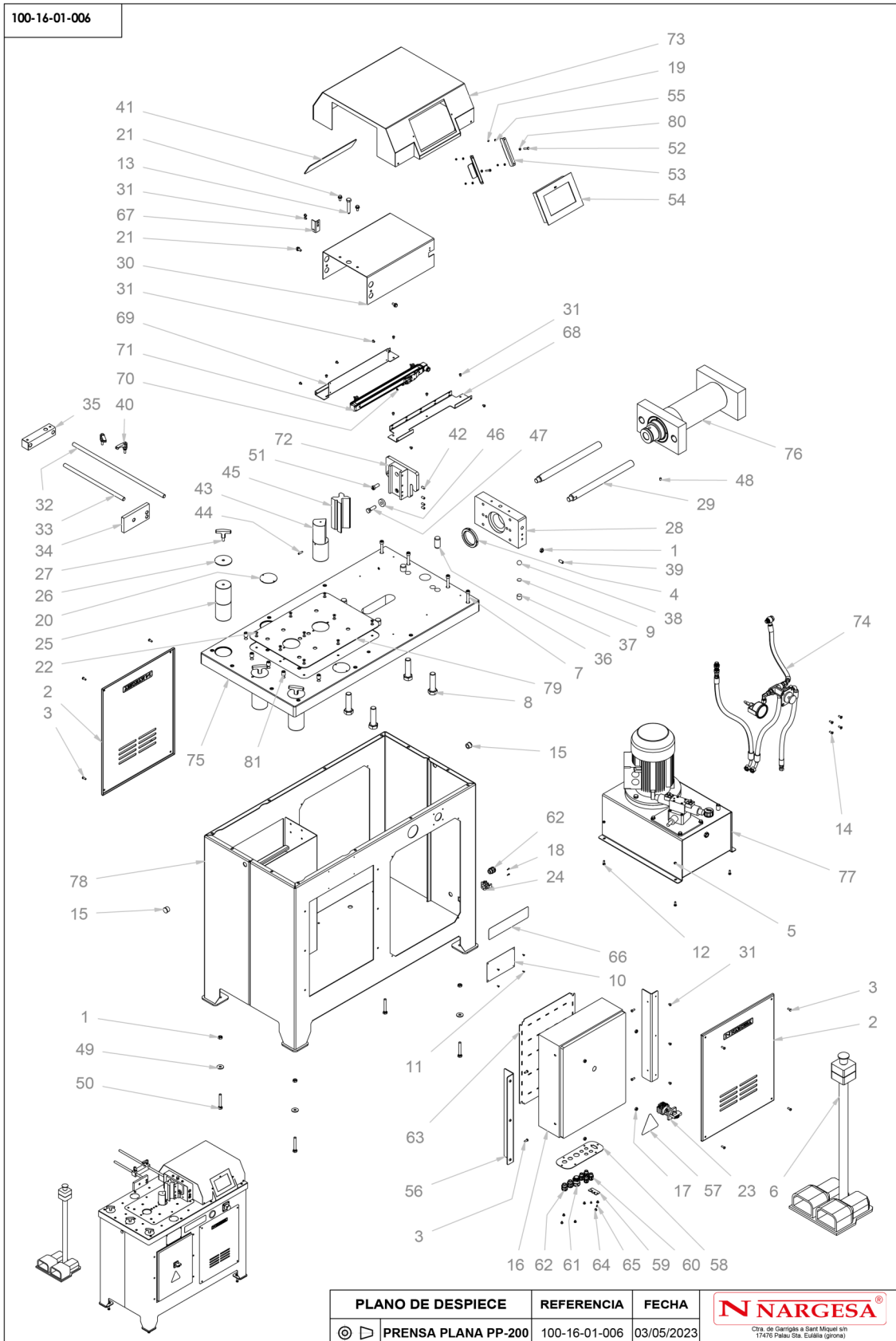









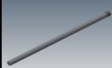
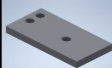
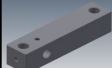

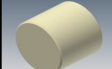
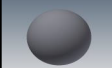

HORIZONTAL PRESS BRAKE PP200CNC

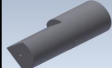
Elemento	Miniatura	Nº de pieza	Descripción	CTDAD
1		020-D934-M10	Tuerca Hexagonal DIN934 M10	18
2		120-16-01-00210	Puerta PP-200	2
3		020-I7380-M6X16	Tornillo Allen Abombado ISO7380 M6X16	8
4		020-D981-KM14	Tuerca Ranurada DIN 981 KM14	1
5		020-D934-M6	Tuerca Hexagonal DIN934 M6	4
6		050-PED-00002	Pedal Doble Con Paro De Emergencia	1
7		020-D912-M10X60	Tornillo Allen DIN 912 M10 X60	12
8		020-D931-M24X90	Tornillo Hex. Media Rosca DIN931 M24X90	4
9		120-16-01-00220	Arandela D19.5X1 Antigiro	2
10		122-PLC-0000-001	Placa Caracteristicas General	1
11		020-D7337-3X8	Remache De Clavo DIN7337 De Al D3X8	4
12		020-D933-M6X16	Tornillo Hexagonal DIN 933 M6X16	4
13		120-16-01-00122	Tornillo Fijacion Utiles PP-200	1
14		020-D7991-M6X16	Tornillo Allen DIN 7991 M6X16	4
15		031-TAP-00005	Tapon De Plastico Para Tubo Redondo D25	2
16		050-COAL-00018	Armario Coalsa 500X400X150 PP-200	1

Elemento	Miniatura	Nº de pieza	Descripción	CTDAD
17		020-D934-M8	Tuerca Hexagonal DIN934 M8	4
18		020-D7985-M3X10	Tornillo DIN7985 M3X10 Zincado	2
19		020-D934-M4	Tuerca Hexagonal DIN934 M4	4
20		120-16-01-00264	Tapa Agujeros D70	3
21		020-D6921-M8X16	Tornillo Hexagonal Embridado Din6921 M8X16	8
22		020-D7991-M6X12	Tornillo Allen Avellanado DIN7991 M6X12	9
23		050-IG-00001	Interruptor General Kg10Ak300	1
24		050-BE-00003	Zocalo Recto Ck03I	1
25		120-16-01-00284	Bulón PP200	3
26		120-16-01-00285	Arandela Apoyo Bulones PP200	3
27		031-MANT-00001	Maneta en T - M10X20 L68	3
28		120-16-01-00290	Tapa Frontal Movil PP-200	1
29		120-16-01-00291	Barra Guia Cilindro PP200	2
30		120-16-01-00289	Chapa Movil PP-200	1
31		020-I7380-M6X8	Tornillo Allen Abombado ISO7380 M6X8	18
32		120-16-01-00118	Barra Principal Tope PP-200	1

HORIZONTAL PRESS BRAKE PP200CNC

Elemento	Miniatura	Nº de pieza	Descripción	CTDAD
33		120-16-01-00119	Barra Auxiliar Tope PP-200	1
34		120-16-01-00305	Pasamano Del Tope PP-200	1
35		120-16-01-00304	Union Barras Tope	1
36		030-D6325-00011	Pasador Cilindrico DIN 6325 D25x50	4
37		120-16-01-00306	Guia Antigiro PP200	2
38		030-BOL-00001	Bola Diametro 20	2
39		020-D914-M10X25	Esparrago Allen Con Punta DIN 914 M10x25	2
40		031-MAG-00005	Empuñadura Graduable Macho M8X20 Negra con Boton Naranja	2
41	120-16-01-00302	Metacrilato Negro Tapa Superior PP200	1	
42		020-D913-M8X16	ESPARRAGO ALLEN DIN 913 M8X16	4
43		125-16-01-00016	Punzón Matriz De Plegar Serie PP-200	1
44		020-D913-M6X25	Esparrago Allen DIN913 M6X25	1
46		120-02-01-00017	Arandela D35XD13X8	2
47		020-D933-M12X40	TORNILLO HEXAGONAL DIN 933 M12x40	2
48		020-D914-M8x12	Esparrago Allen Con Punta DIN914 M8X12	1
49		020-D9021-M10	ARANDELA DIN 9021 M10	4

Elemento	Miniatura	Nº de pieza	Descripción	CTDAD
50		020-D933-M10X70	Tornillo Hexagonal DIN 933 M10x70	4
51		020-D6912-M12X30	Tornillo Allen Cabeza Reducida Din6912 M12X30	2
52		020-I7380-M6X30	TORNILLO ALLEN ABOMBADO ISO7380 M6X30	2
53		120-17-01-00042	CHAPA SOPORTE PANTALLA ESA S625	2
54		050-CNC-00003	Pantalla ESA S625	1
55		020-D125B-M4	Arandela Biselada DIN125B Para M4	4
56		120-16-01-00317	Soporte Cuadro Electrico PP200	2
57		122-ADH-00003	Adhesivo Triangulo 400Vac De 100 Mm	1
58		120-16-01-00318	Chapa Prensaestopas	1
59		120-02-04-00169	Tapa Pasacables	1
60		050-PE-00002	Prensaestopa PG9 Negro	4
61		050-PE-00008	PRENSAESTOPA M25	1
62		050-PE-00006	Prensaestopa M20X1.5	3
63		120-16-01-00319	Chapa Montaje	1
64		020-I7380-M6X6	Tornillo Allen Abombado ISO7380 M6X6	6
65		020-I7380-M4X6	Tornillo Allen Abombado ISO7380 M4X6	2

HORIZONTAL PRESS BRAKE PP200CNC

Elemento	Miniatura	Nº de pieza	Descripción	CTDAD
66		122-CAL-0602-002	Calca PP200, C2006 i C3006	1
67		120-16-01-00349	Chapa Seguidor Potenciómetro PP200	1
68		120-16-01-00350	Chapa Soporte Tapa superior PP200	1
69		120-16-01-00351	Chapa Soporte Potenciómetro Lineal PP200	1
70		020-D125B-M5	Arandela DIN 125 B M5	2
71		050-ENC-00011	Potenciómetro RPH 275 5K C	1
72		131-16-01-00040	Conjunto Base Matriz De Plegar PP-200	1
73		130-16-01-00240	Tapa Superior PP200	1
74		130-16-01-00228	Montaje Instalacion Hidraulica PP-200	1
75		130-16-01-00227	Conjunto Mesa Trabajo PP-200	1
76		130-16-01-00225	Conjunto Cilindro Montado	1
77		130-16-01-00220	Grupo Hidraulico PP-200	1
78		130-16-01-00218	Conjunto Estructura Pie PP-200	1
79		120-16-01-00355	Chapa Antidesgaste Mesa PP200	1
80		020-AET-M6	Arandela Especial para DIN912 AET - M6	2
81		DIN 913 - M16 x 20	Tornillo de ajuste de boquilla hexagonal	15

A2. Piston assembly

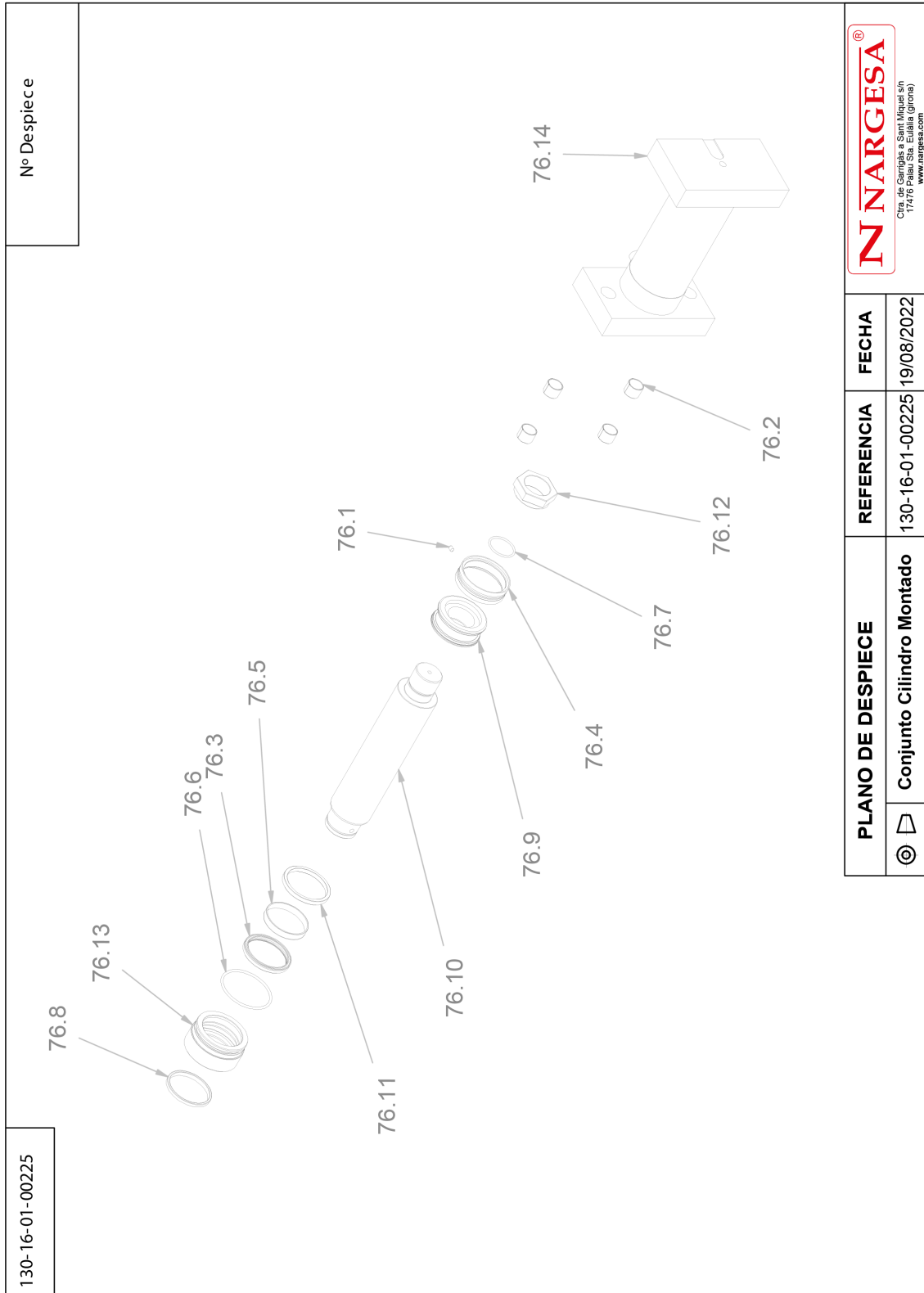

Ctra. de Garrigàs a Sant Miquel s/n
17476 Palafrugades, Eulalia (Girona)
www.nargesa.com

PLANO DE DESPIECE	REFERENCIA	FECHA
	130-16-01-00225	19/08/2022
	Conjunto Cilindro Montado	

Este plano es propiedad de Prada Nargesa SL. No podrá ser reproducido, comunicado a terceros o utilizado para otro fin que no sea el acordado sin su permiso escrito.

Elemento	Miniatura	Nº de pieza	Descripción	CTDAD
76.1		020-D914-M8x12	Esparrago Allen Con Punta DIN914 M8X12	1
76.2		030-DP-00012	Dolla Partida D30XD34X25	4
76.3		040-BA-00015	Collarin Ba D90XD105X11.4	1
76.4		040-DPS-00007	Junta DPS D110XD96X22.5X33	1
76.5		040-GSF-00001	GUIA SF D90XD95X15	1
76.6		040-JT-00026	JUNTA TORICA Ø105X5 90 Shore	1
76.7		040-JT-00027	JUNTA TORICA D52X4 90 Shore	1
76.8		040-RAS-00008	Rascador D90XD100X7/10	1
76.9		120-16-01-00223	Empaquetadura Cilindro PP-200 D110xD90	1
76.10		120-16-01-00225	Vastago Cilindro D110xD90 PP-200	1
76.11		120-16-01-00229	Aro Separador Cilindro D110xD90 PP-200	1
76.12		120-16-01-00230	Tuerca Trasera Cilindro PP-200	1

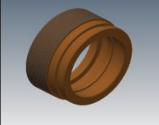
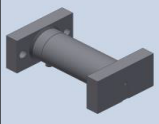
Elemento	Miniatura	Nº de pieza	Descripción	CTDAD
76.13		120-16-01-00282	Dolla De Bronce Cilindro PP-200 D110xD90	1
76.14		130-16-01-00226	Conjunto Camisa Cilindro D110XD90 PP-200	1



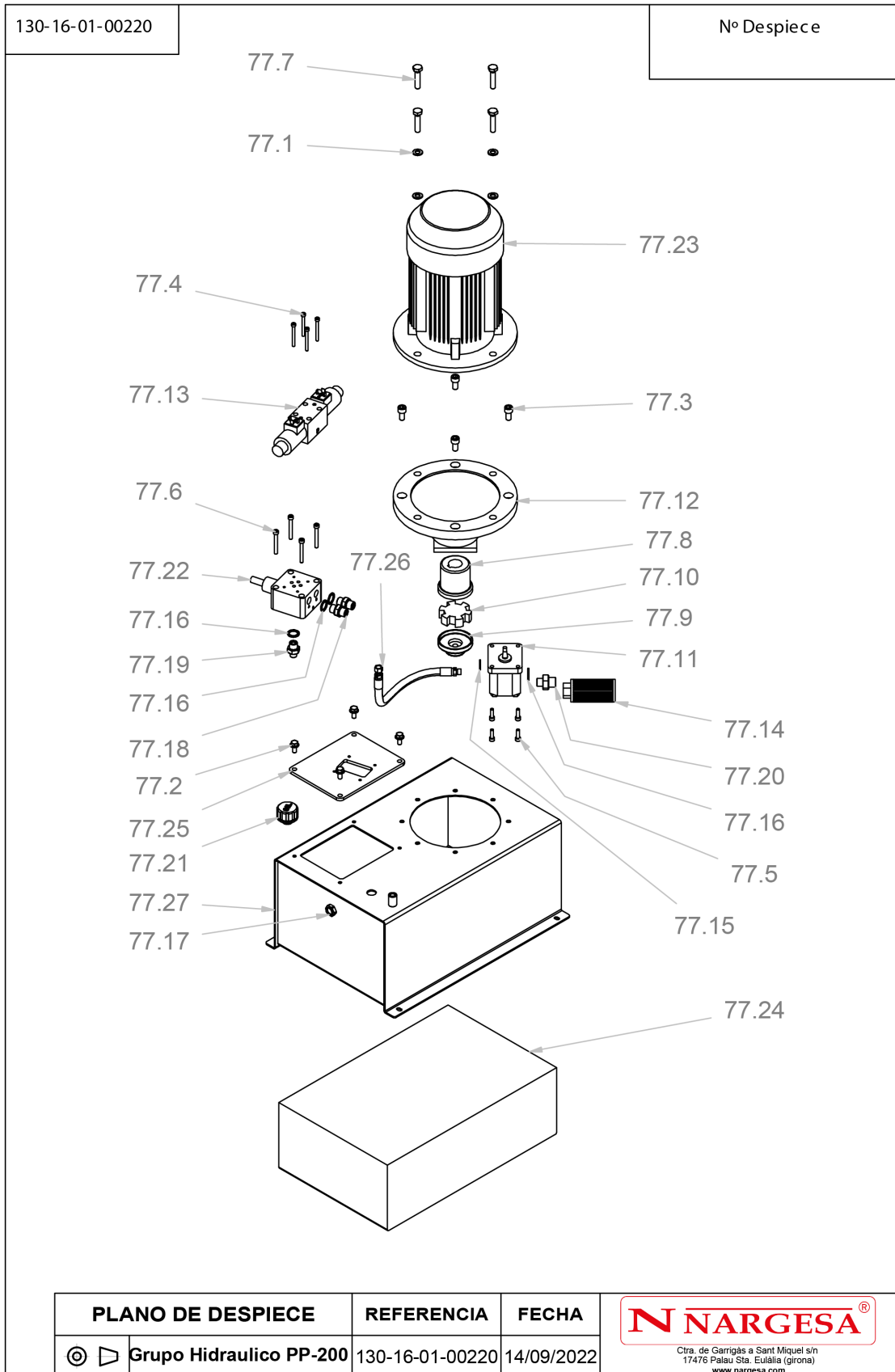





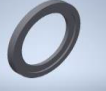
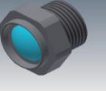

A3. Hydraulic group



Este plano es propiedad de Prada Nargesa SL. No podrá ser reproducido, comunicado a terceros o utilizado para otro fin que no sea el acordado sin su permiso escrito.

Elemento	Miniatura	Nº de pieza	Descripción	CTDAD
77.1		020-D125B-M10	Arandela Biselada DIN125B Para M10	4
77.2		020-D6921-M8X16	Tornillo Hexagonal Embridado Din6921 M8X16	4
77.3		020-D912-M10X20	Tornillo Allen DIN912 M10X20	4
77.4		020-D912-M5X50	Tornillo Allen DIN912 M5X50	4
77.5		020-D912-M6X20	TORNILLO ALLEN DIN912 M6X20	4
77.6		020-D912-M6X50	TORNILLO ALLEN DIN912 M6X50	4
77.7		020-D933-M10X45	Tornillo Hexagonal DIN933 M10X45	4
77.8		040-AE-00007	Acoplamiento Lado Motor 3/4 / 5.5Cv	1
77.9		040-AE-00008	Acoplamiento Lado Bomba Lo Para Motor 3/4 / 5.5 Cv	1
77.10		040-AE-00009	Estrella Acoplamiento Para Motor 3/4 / 5.5 Cv	1
77.11		040-BH-00006	Bomba Hidraulica De Aluminio De 5 L 1LO5DE10R	1
77.12		040-CA-00002	Campana Acoplamiento Bomba Tipo Lo Motor 3/4/5.5 CV	1
77.13		040-ELV-00012	Electrovalvula Doble Bobina 5EVP3D1C02D24	1
77.14		040-FL-00002	Filtro De Aspiracion 1/2' REF 2FA15R125N	1
77.15		040-JMG-00002	Junta Metal Goma 1/4' Gas	1

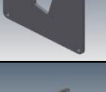
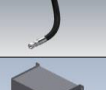
HORIZONTAL PRESS BRAKE PP200CNC

Elemento	Miniatura	Nº de pieza	Descripción	CTDAD
77.16		040-JMG-00004	Junta Metal Goma 3/8' Gas	4
77.17		040-NA-00001	Visor Nivel Aceite De 3/8' Gas	1
77.18		040-RMM-00003	Racor 3/8" Macho Macho	2
77.19		040-RRMM-00002	Racor Reducido 3/8'-1/4' Macho Macho	1
77.20		040-RRMM-00004	Racor Reducido 1/2-3/8 Macho Macho	1
77.21		040-TLL-00003	Tapon Llenado De 1/2' Doble Respiradero Y Filtro	1
77.22		040-VLP-00002	Valvula Limitadora Presion 5R1102P2F/03 -T210 tarada a 210 Bares	1
77.23		050-ME-00003	Motor Electrico 2.2Kw 1500Rpm 50-60Hz B5 220/380V	1
77.24		120-16-01-00251	Aceite Hidraulico HM68 25 Litros	1
77.25		120-16-01-00275	Placa Componentes Hidraulicos PP-200	1
77.26		120-16-01-00281	Manguera Flexible 1/4' Macho 1/4'-Tg 1/4' L= 430 mm Presion De Trabajo 250 Bars	1
77.27		130-16-01-00215	Desposito Hidráulico PP-200	1

A4. Control panel

-CONTROL1

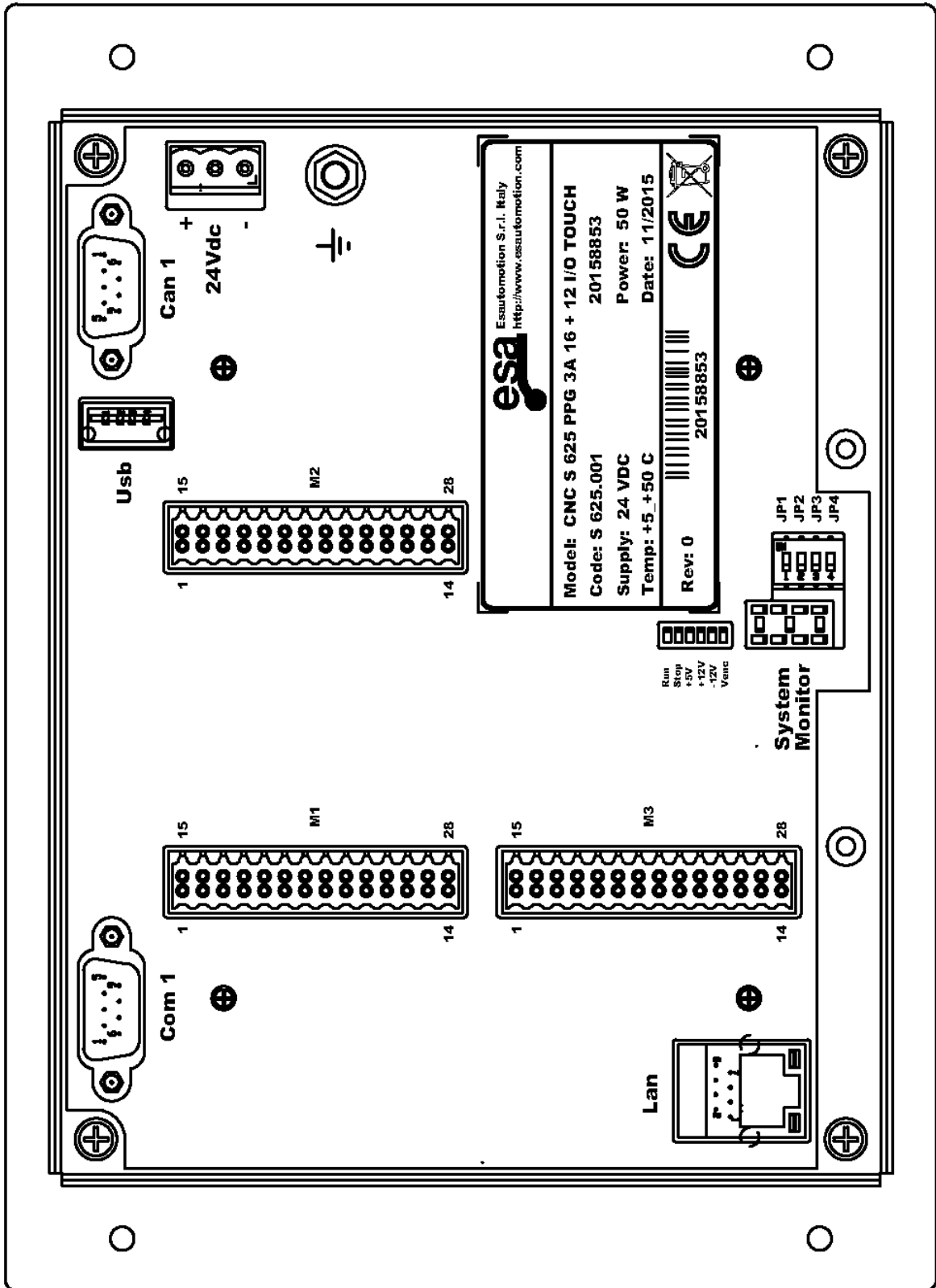

A5. Electric map · THREEPHASE MACHINE

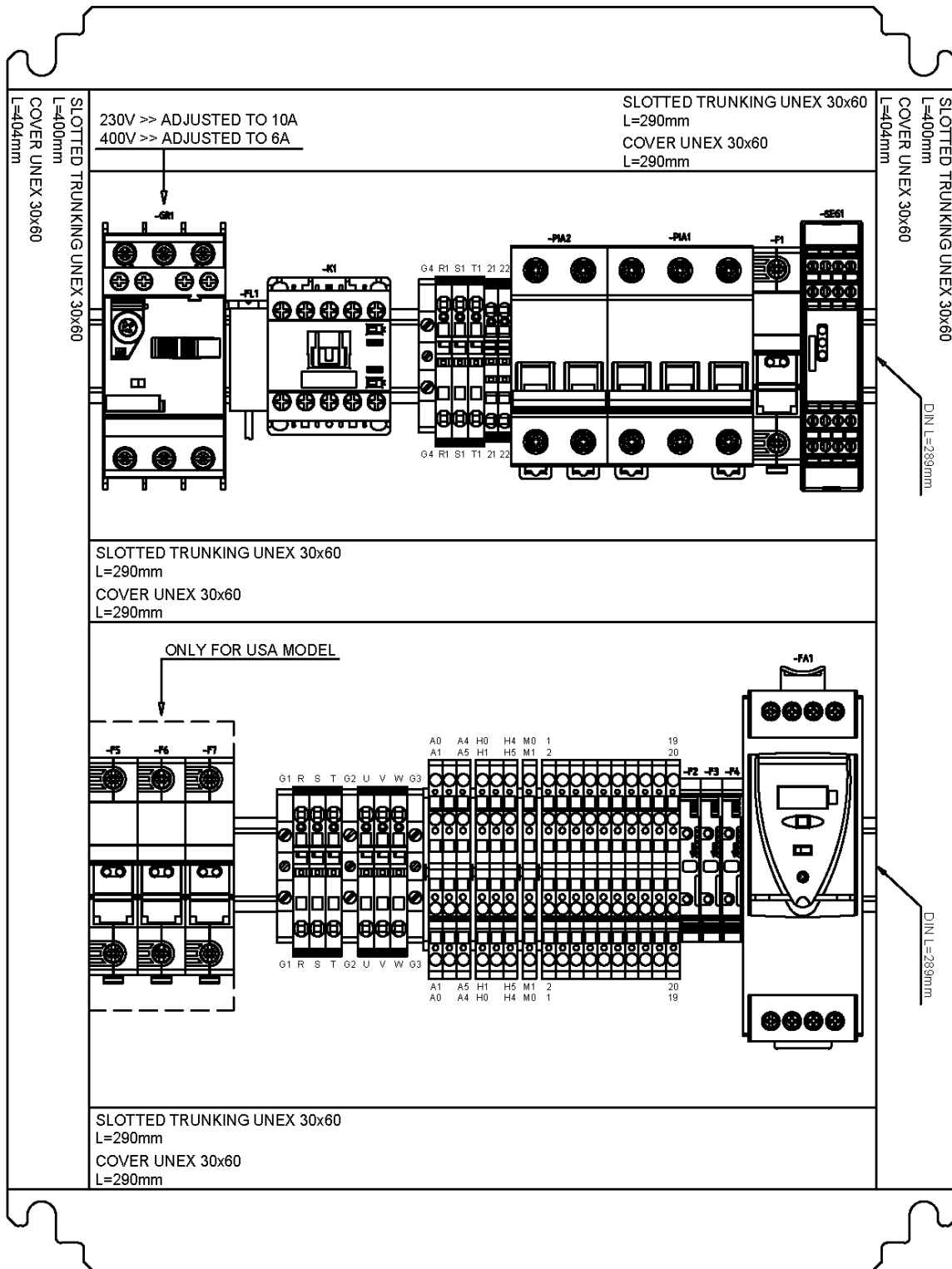

A6. Electric map · SINGLEPHASE MACHINE

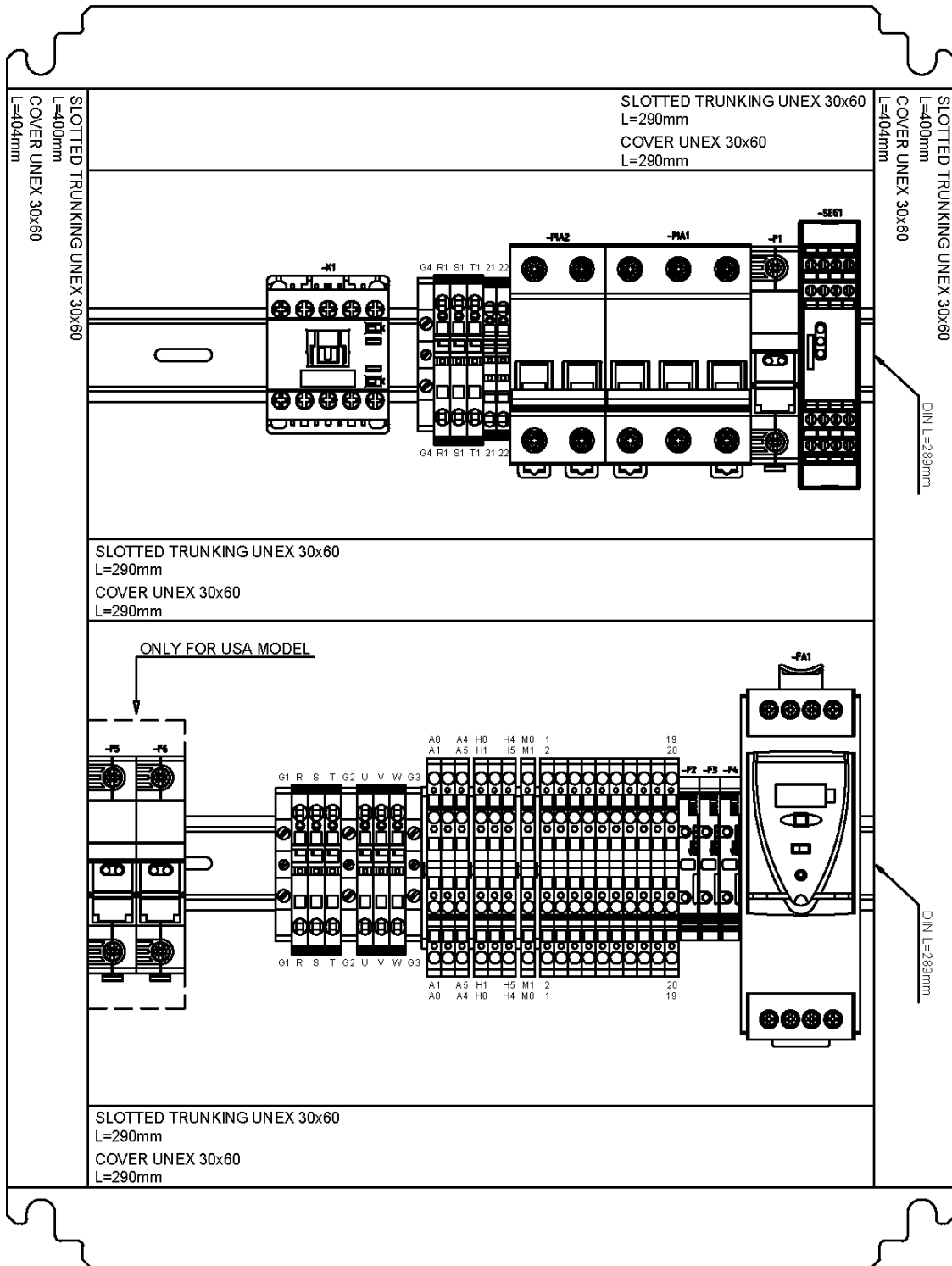

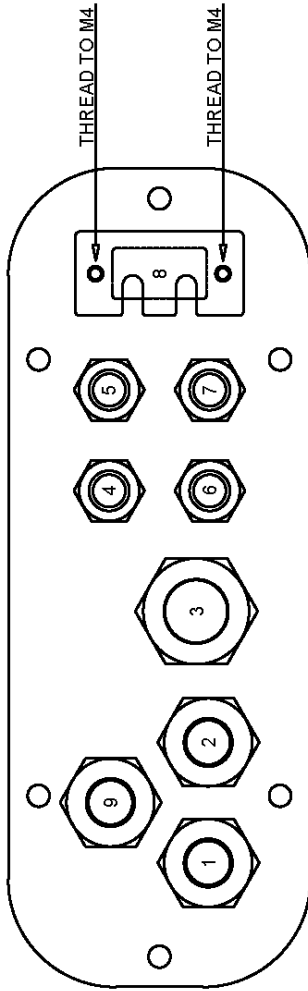

3 PHASE MODEL			
PLATE HOLE NUMBER	PLASTIC CABLE GLAND	ELECTRIC WIRE	DESCRIPTION
1	M20	MG1	POWER INPUT
2	M20	MG2	PUMP MOTOR
3	M25	---	MESH WITH SIGNAL WIRES
4	PG9	---	---
5	PG9	MG6	EVR (REVERSE ELECTROVALVE)
6	PG9	MG3	PEDAL
7	PG9	MG5	EVF (FORWARD ELECTROVALVE)
8	---	MG8	ETHERNET
9	M20	---	MESH TO THE BACK GAUGE CONNECTOR

SINGLE PHASE MODEL			
PLATE HOLE NUMBER	PLASTIC CABLE GLAND	ELECTRIC WIRE	DESCRIPTION
1	M20	MG1	POWER INPUT
2	M20	MG10	VF POWER INPUT
3	M25	---	MESH WITH SIGNAL WIRES
4	PG9	MG9	VF FORWARD CONTROL
5	PG9	MG6	EVR (REVERSE ELECTROVALVE)
6	PG9	MG3	PEDAL
7	PG9	MG5	EVF (FORWARD ELECTROVALVE)
8	---	MG8	ETHERNET
9	M20	---	MESH TO THE BACK GAUGE CONNECTOR

A7. Pedal connection

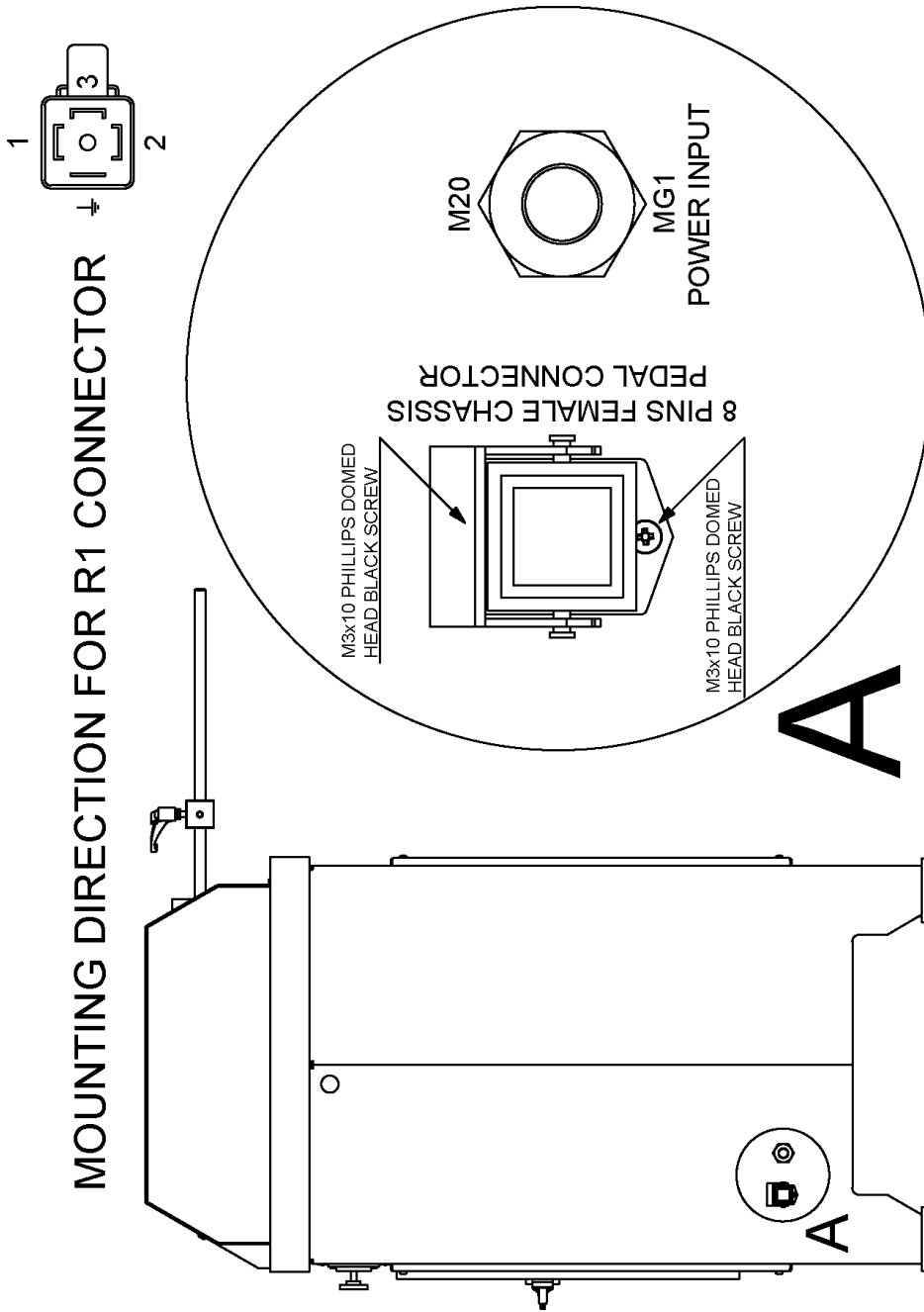

A8. Hydraulic group

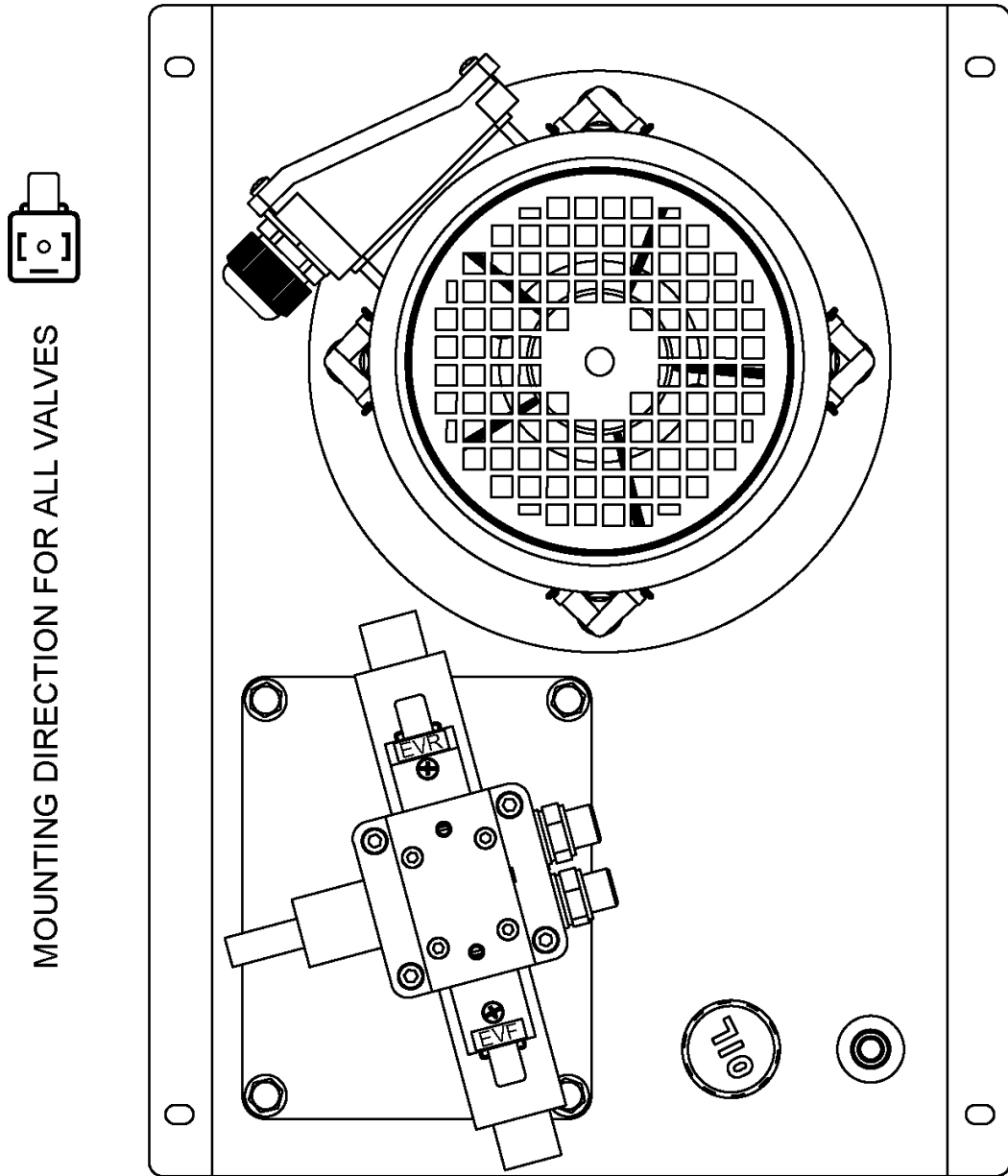

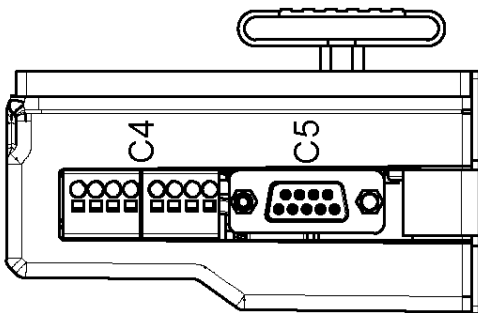
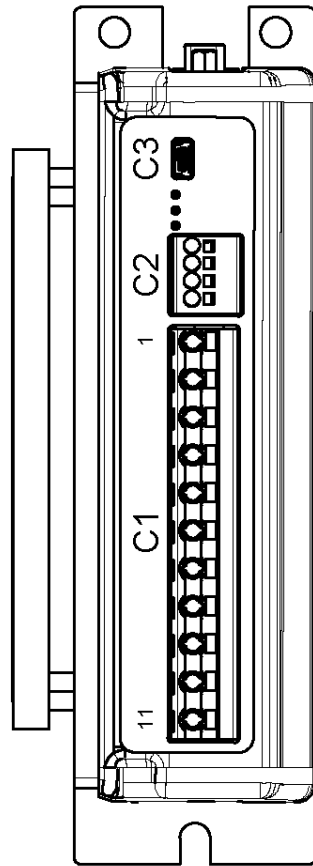
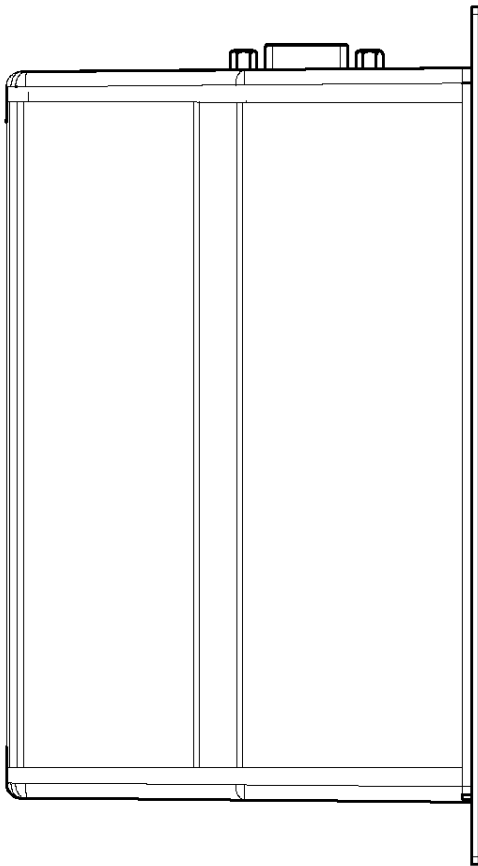
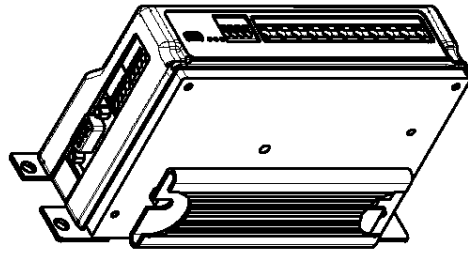
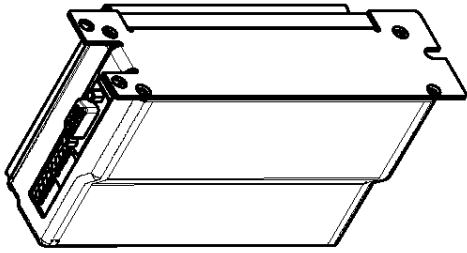

A9. Electric map · THREEPHASE MACHINE

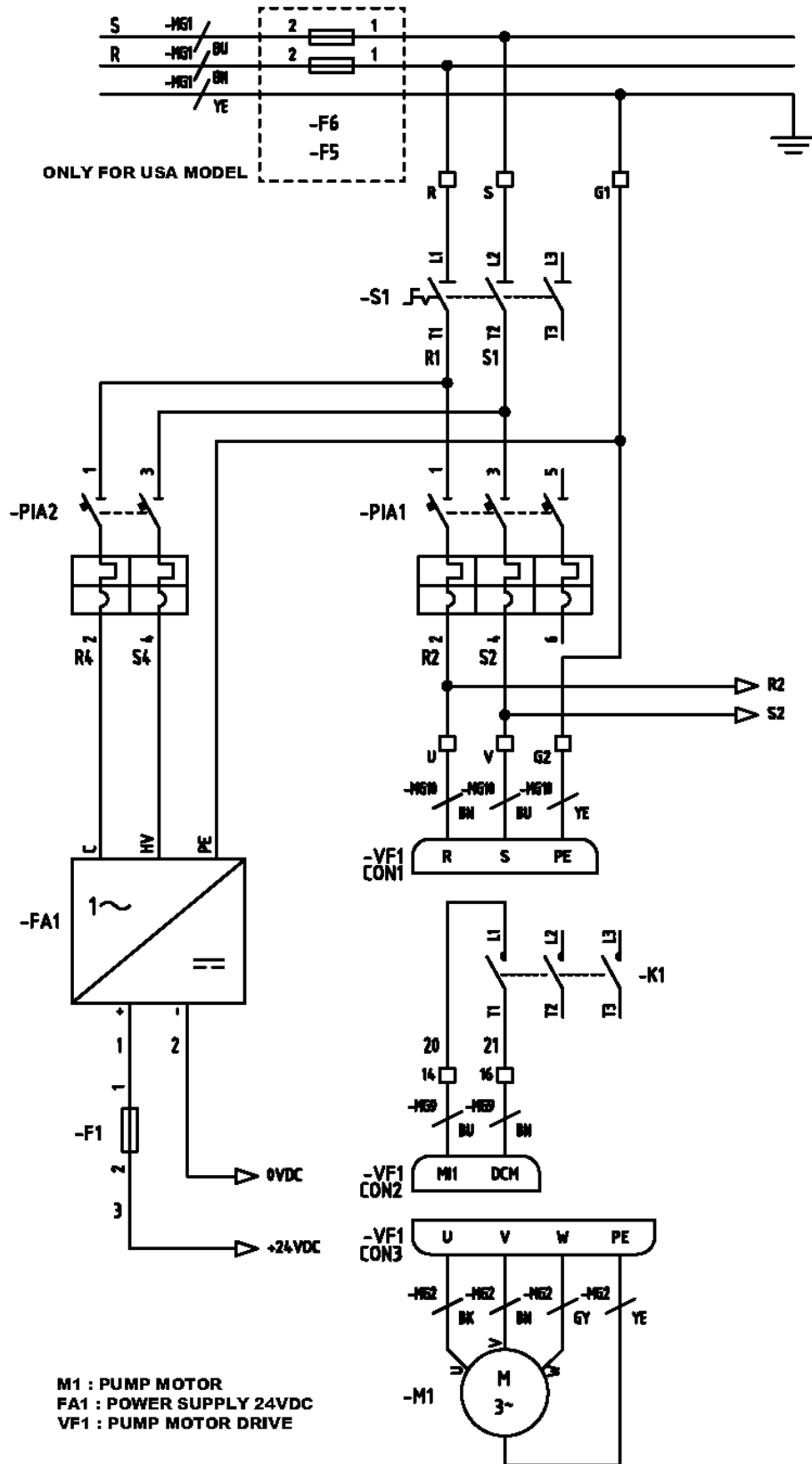

A10. Electric map · SINGLEPHASE MACHINE

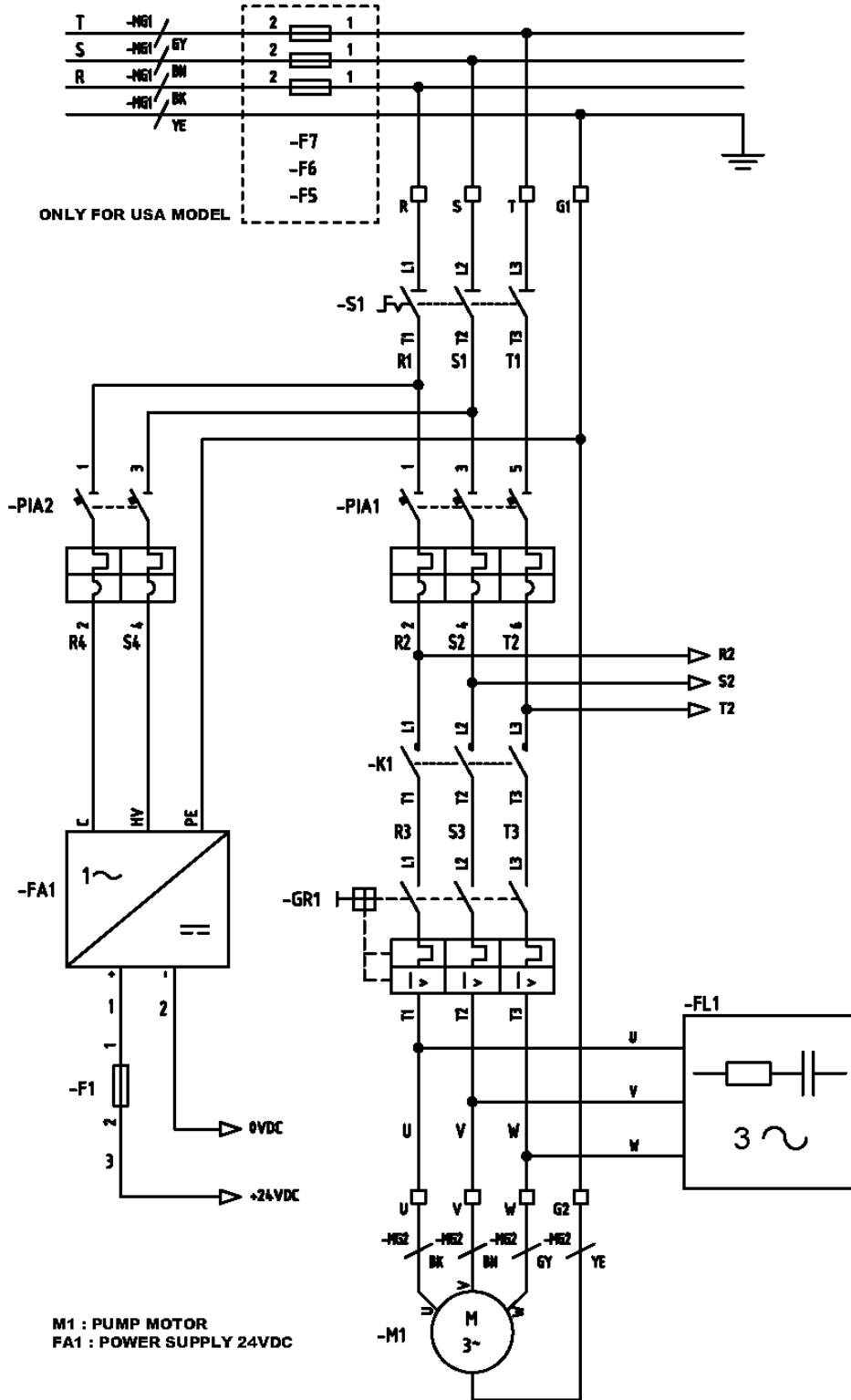

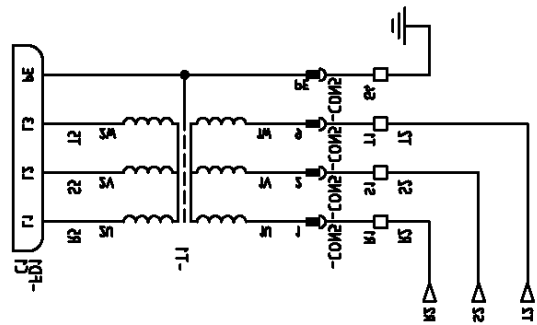
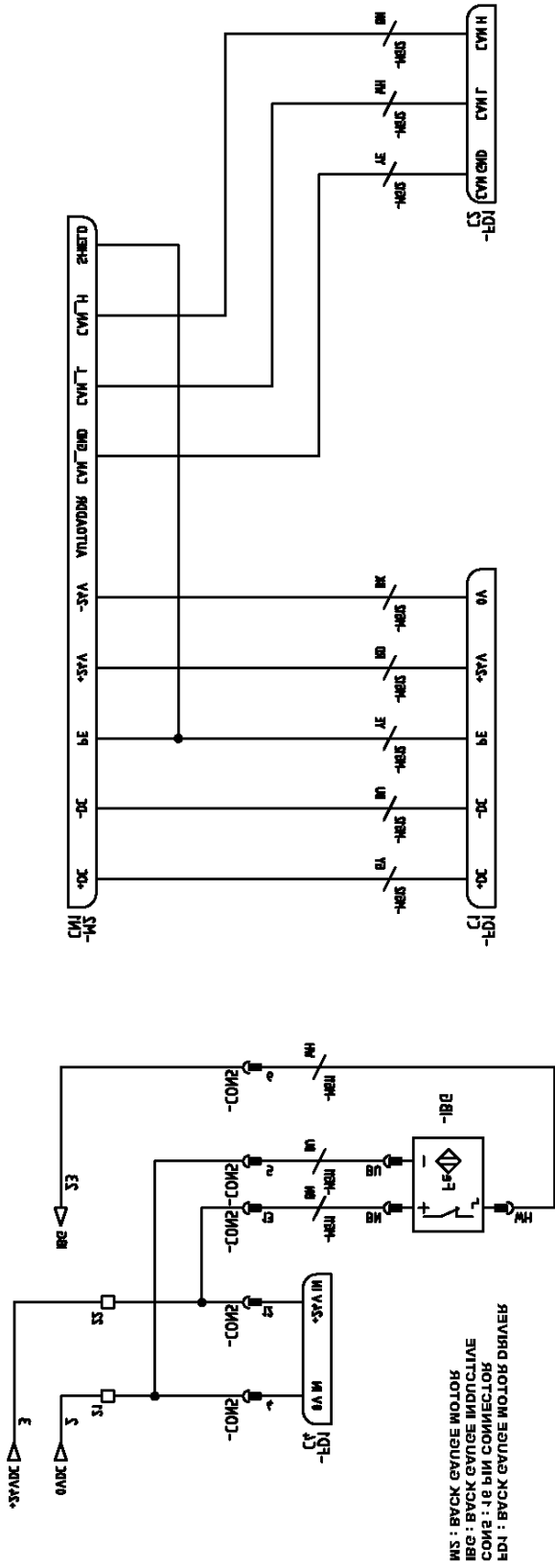

3 PHASE MODEL

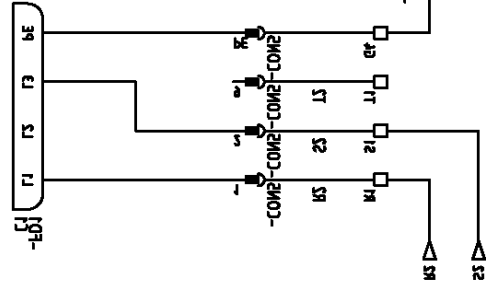

SINGLE PHASE MODEL

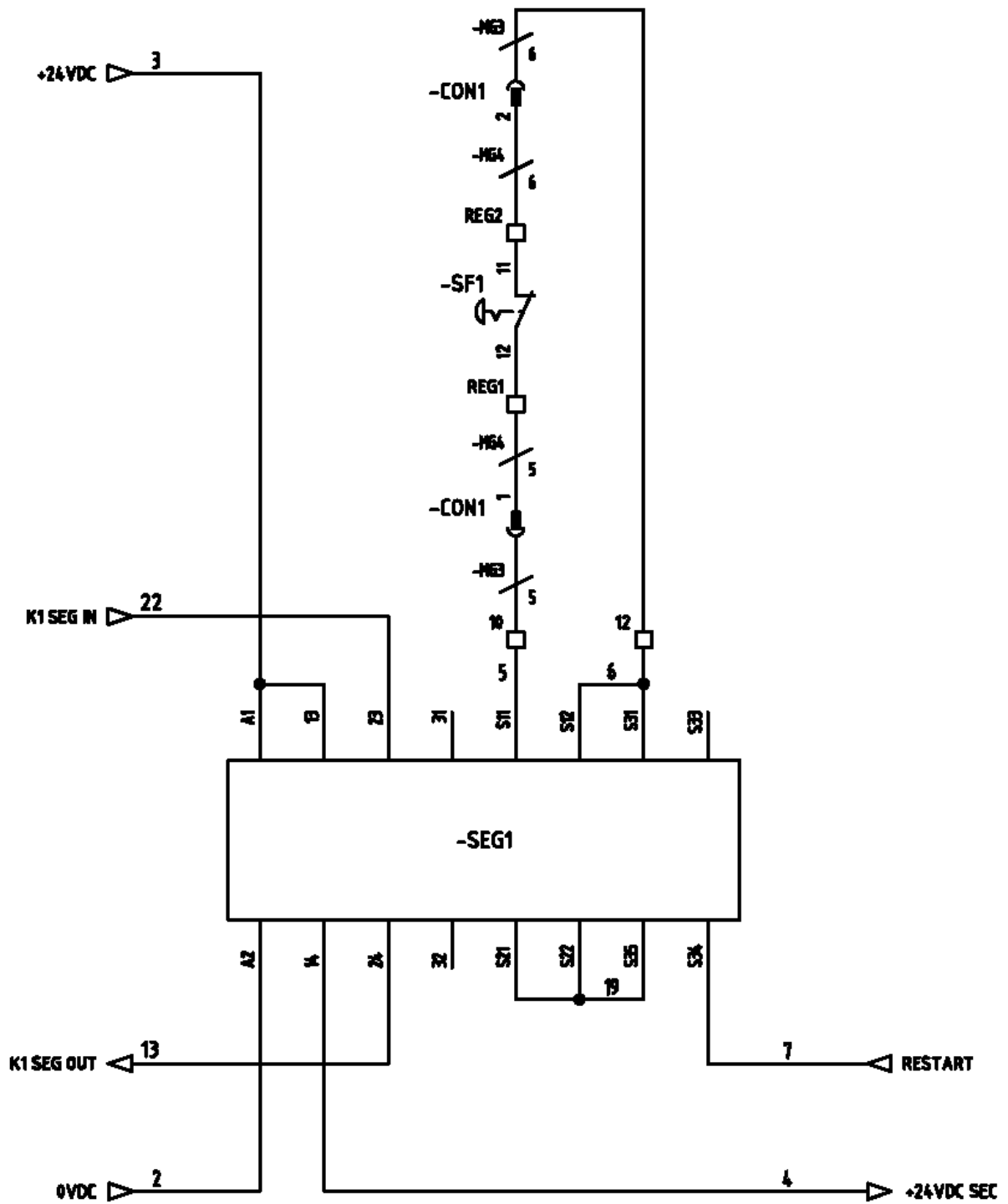

SF1 : PEDAL EMERGENCY STOP

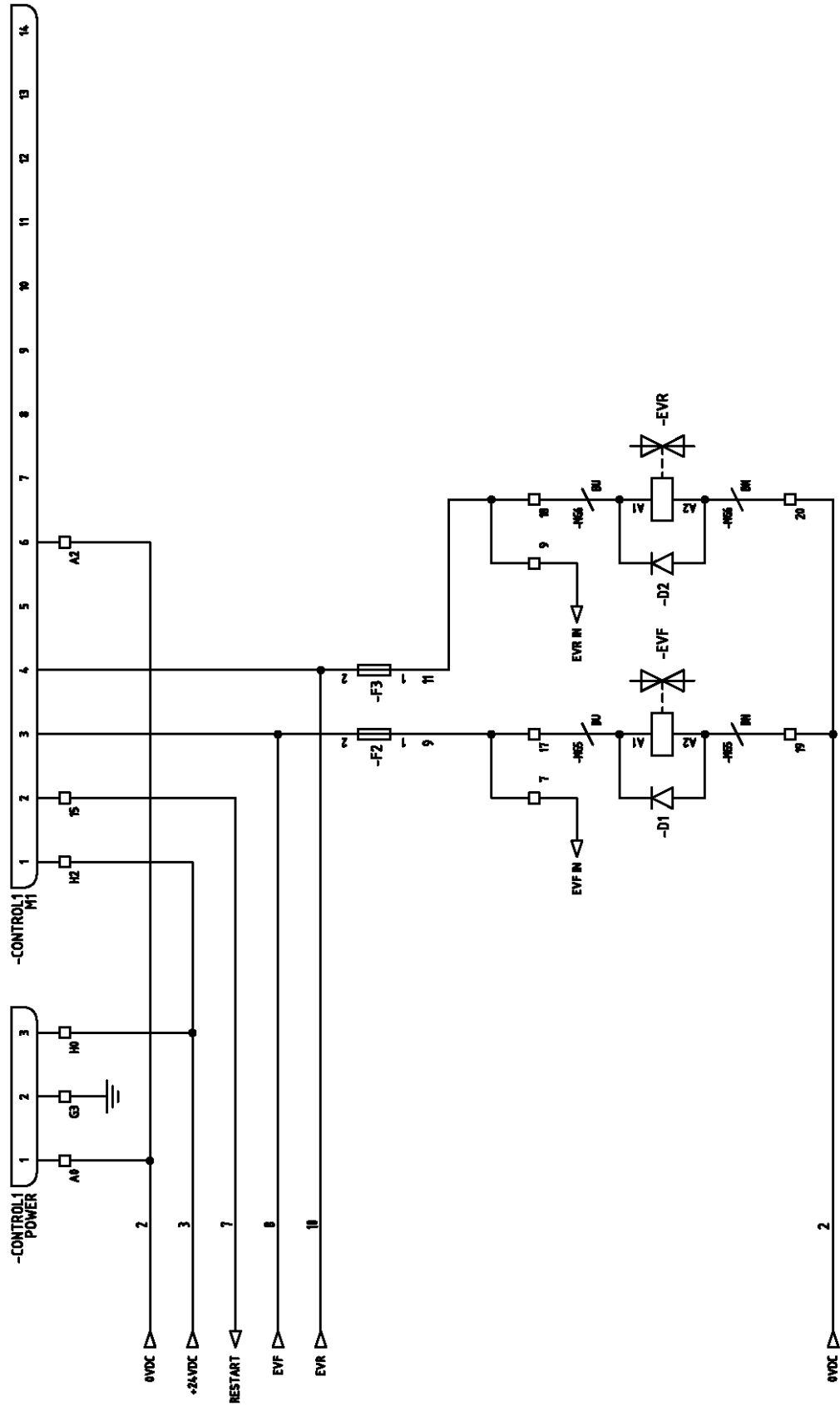

CONTROL1 : S625 ESA NUMERIC CONTROL
 EVF : FORWARD ELECTROVALVE
 EVR : REVERSE ELECTROVALVE

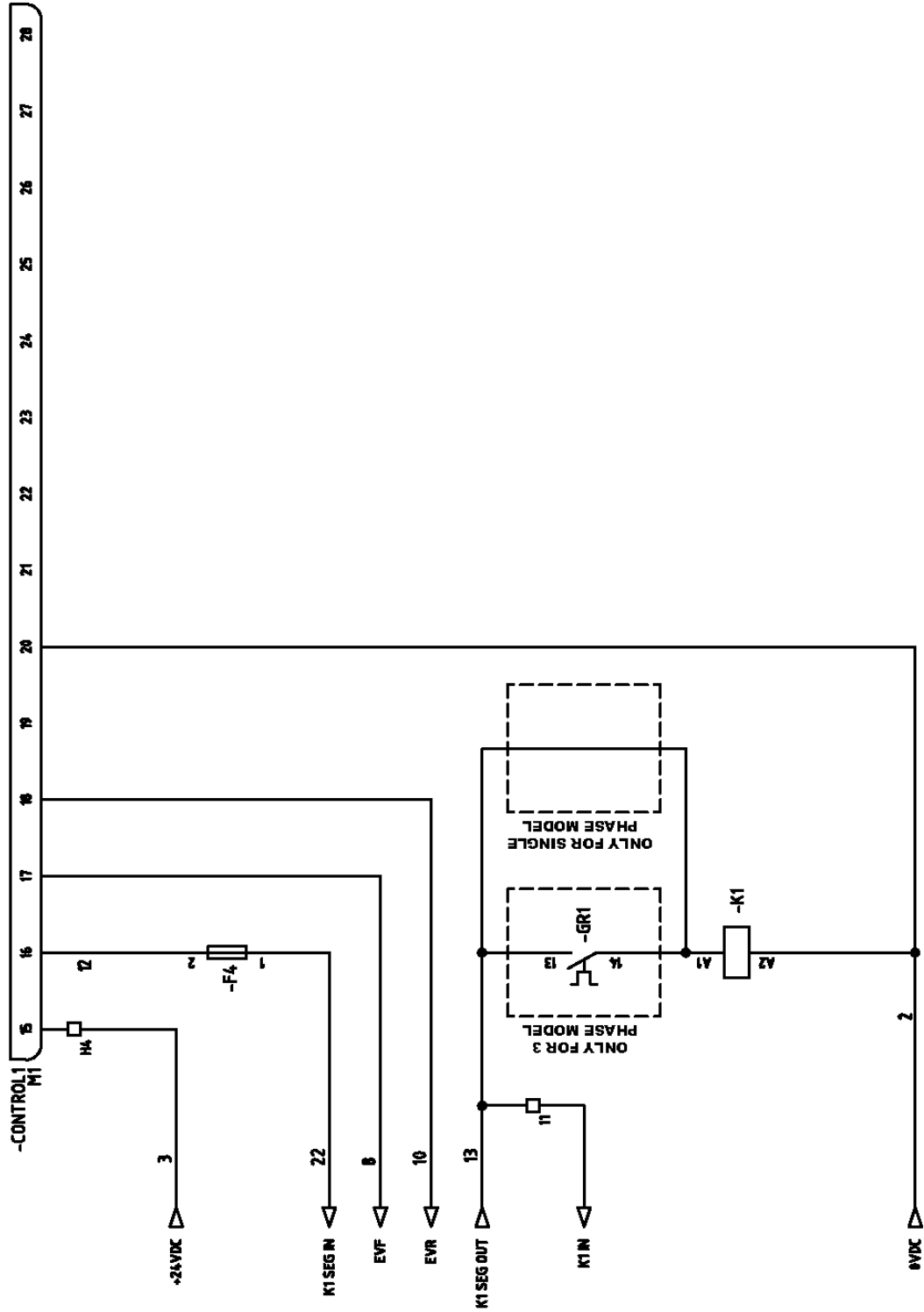

CONTROL 1 : S625 ESA NUMERIC CONTROL

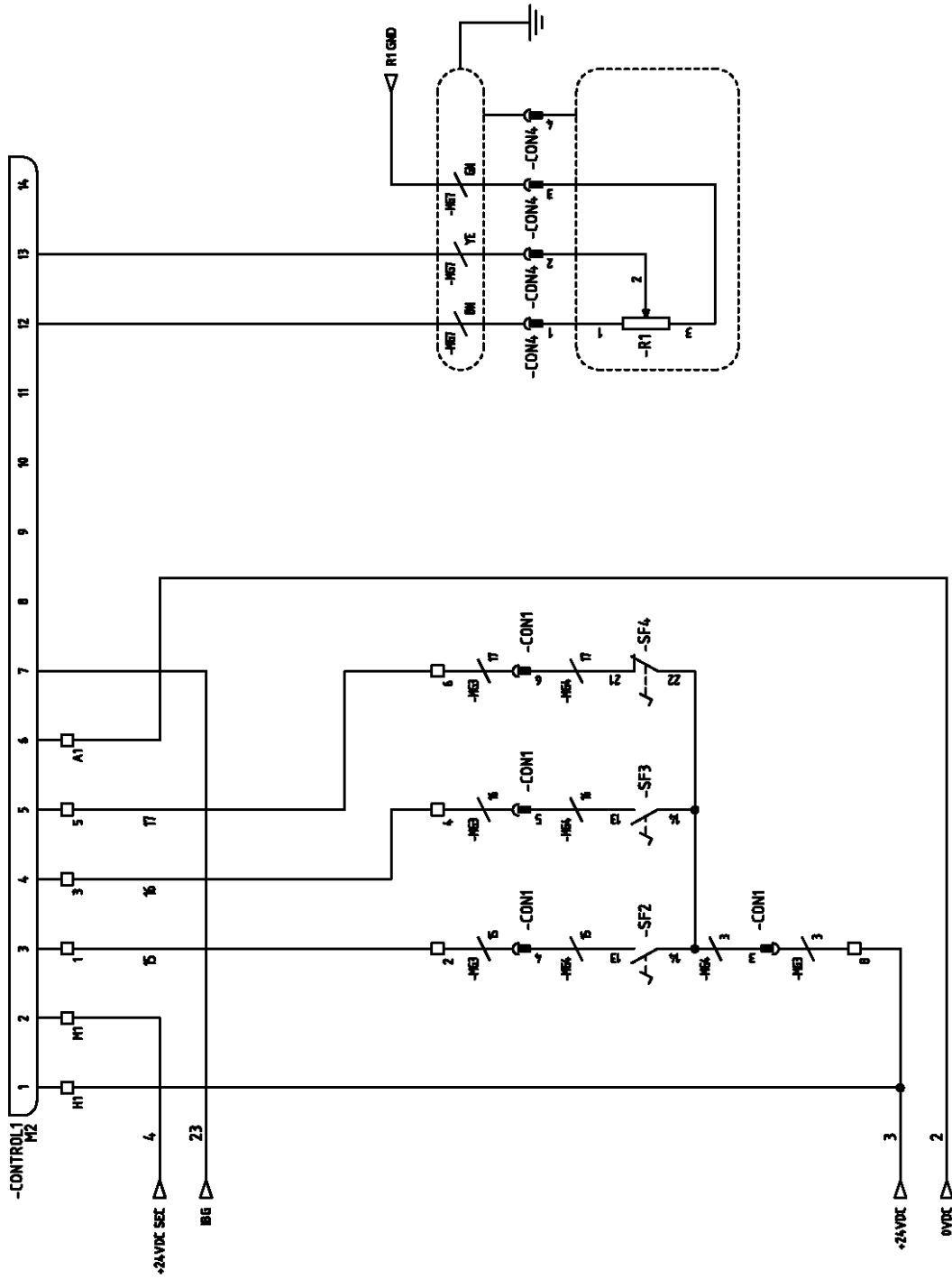

CONTROL1 : S625 ESA NUMERIC CONTROL
 SF2 : FORWARD PEDAL
 SF3 : REVERSE PEDAL
 SF4 : DEAD MAN PEDAL
 R1 : 5K LINEAR POTENTIOMETER

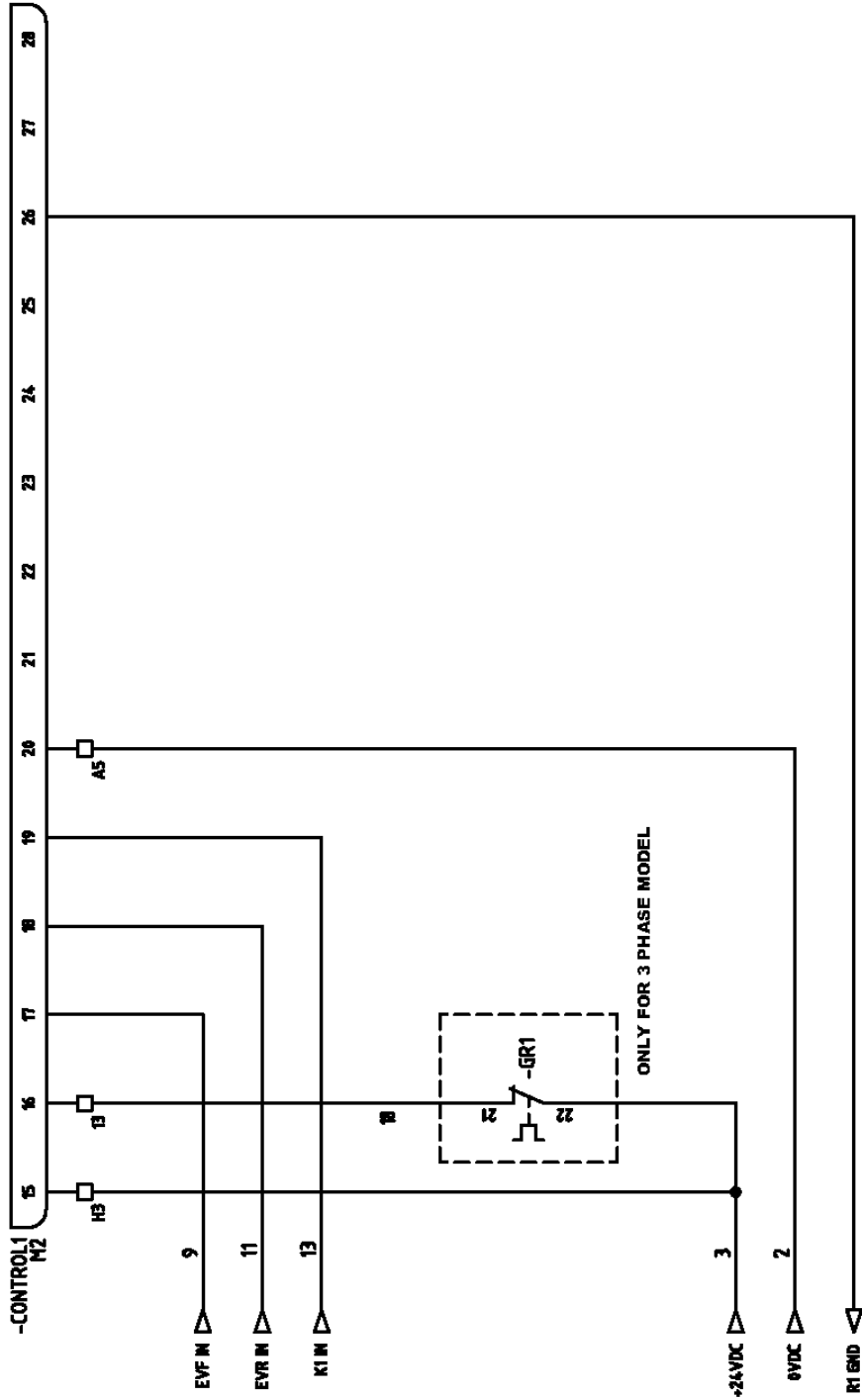

CONTROL1 : S625 ESA NUMERIC CONTROL

ETHERNET EXTENSION CABLE

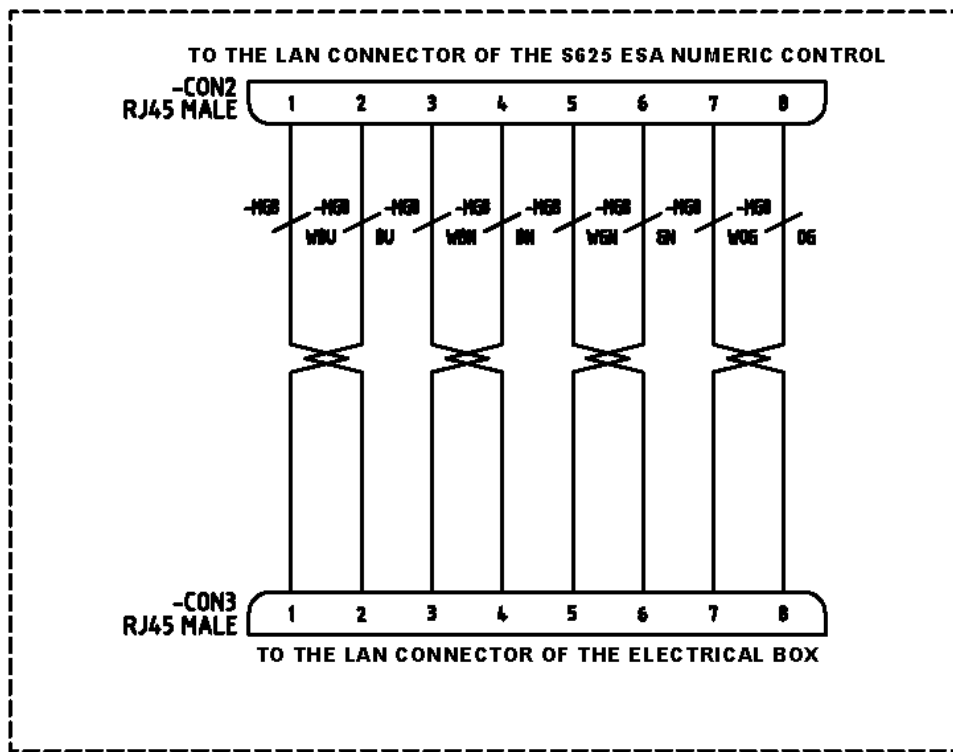

CAN BUS CABLE

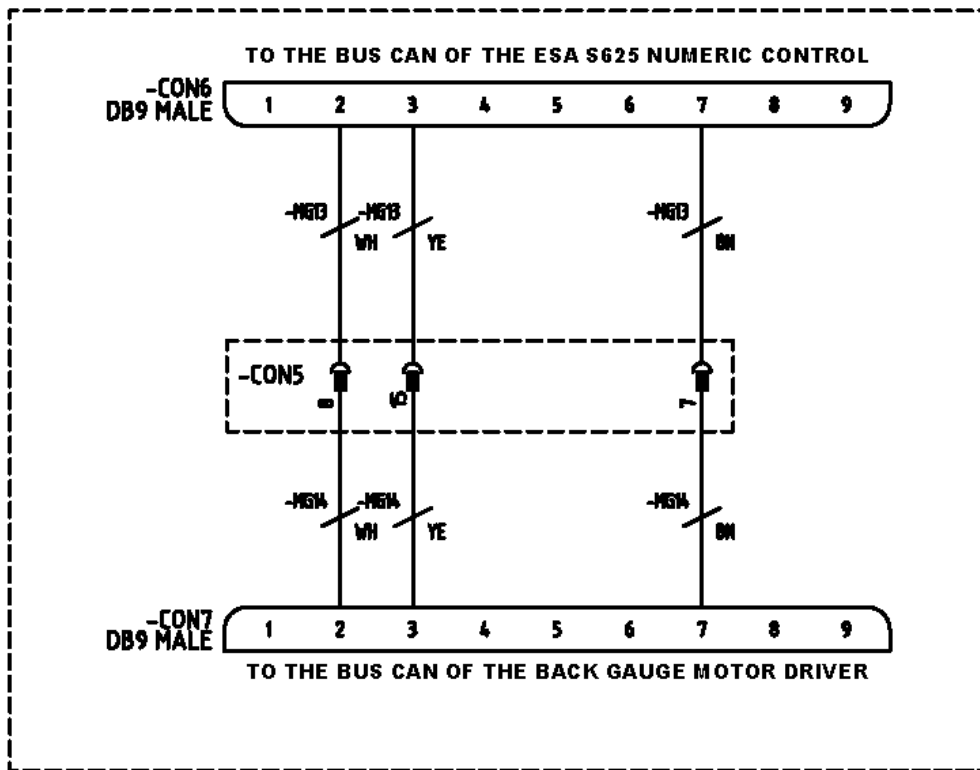

A11. Hydraulic map

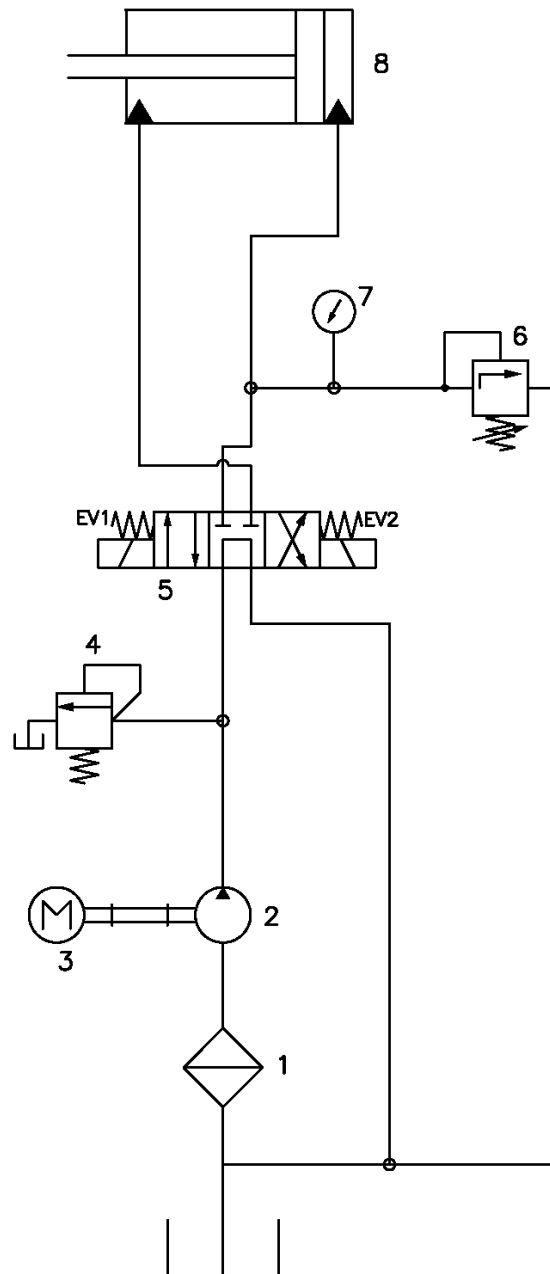

- 1. Filtro
- 2. Bomba hidráulica
- 3. Motor Eléctrico
- 4. Limitadora de presión
- 5. Electroválvula principal
- 6. Limitadora de presión regulable

Technical features - Tooling

Folding die at 161 mm. V16, 22, 35, 50 mm.

Ring forming die

REF: 140-16-01-00003

Twisted bars forming die

REF: 140-16-01-00013

Promecampunch holder

REF: 140-16-01-00023

Bar clamps forming die

REF: 140-16-01-00028

Folding die at 161 mm. V16, 22, 35, 50 mm.

Description

Folding or bending die up to 161mm with 4 openings (16, 22, 35, 50mm) and a punch of 88°. This multi-V die allows 1mm up to 8mm sheet to be folded. The 70mm outer die diameter punch allows to make completely closed shapes to a minimum of 75mm inner wing.



V16	Sheet from 1 to 3mm
V22	Sheet from 2 to 4mm
V35	Sheet from 3 to 6mm
V50	Sheet from 4 to 8mm
Max. Folding length	161 mm
Max. Folding thickness	8 mm
<i>* For other measures, request the manufacturer.</i>	

Parts list

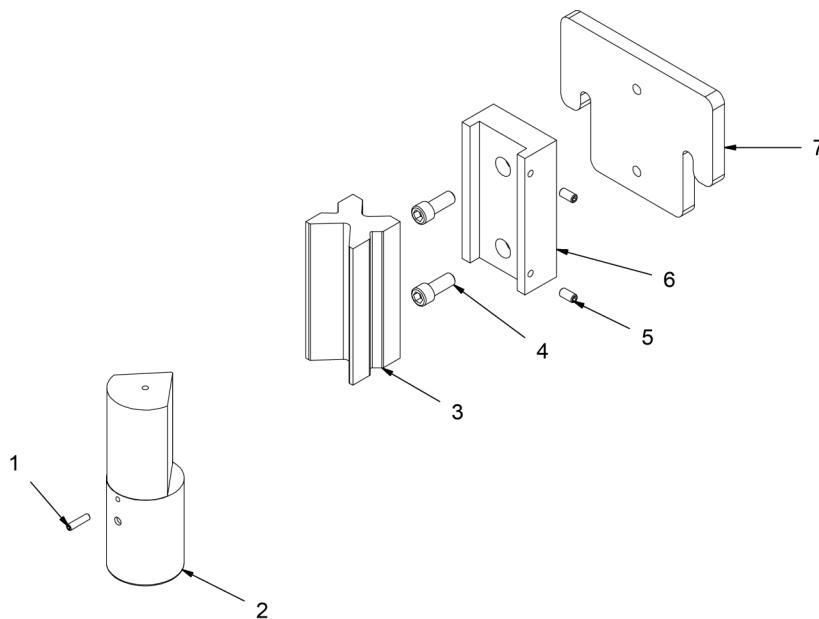

Element	REF	Description	Quant.
1	020-D913-M6X25	ESPARRAGO ALLEN DIN 913 M6X25	1
2	125-16-01-00016	PUNZON MATRIZ DE PLEGAR SERIE PP-200	1
3	125-16-01-00006	MATRIZ DE PLEGADO 20.09X150	1
4	020-D912-M12X30	TORNILLO ALLEN DIN 912 M12x30	2
5	020-D913-M8X16	ESPARRAGO ALLEN DIN 913 M8X16	2
6	125-16-01-00005	GUIA REGLA PLEGADO	1
7	125-16-01-00004	BASE MATRIZ PLEGAR SERIE PP-200	1

Ring forming die

Description

Die to form rings or English banister railing, used as ornamental piece in forging railings, gates, fences... for bars bonding. For other sizes and applications consult the manufacturer.

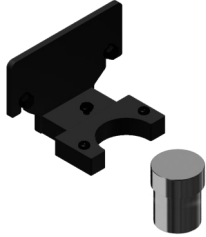

Max. width	Thickness	Outer sizes	Weight
50 mm	6 mm	90 mm	9.3 Kg

* For different sizes, please ask the manufacturer

Parts list

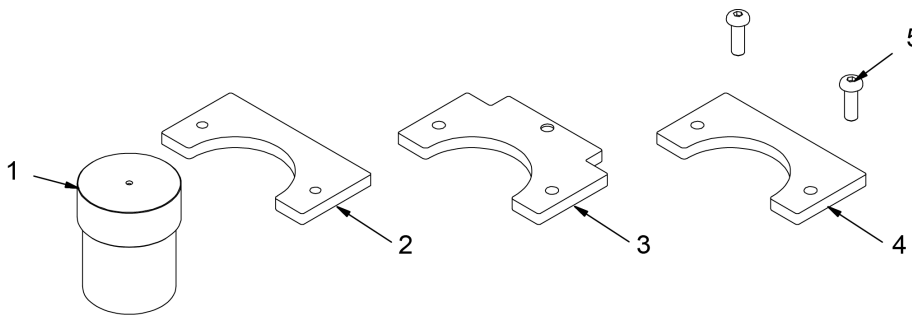

Element	REF	Description	Quant.
1	125-16-01-00166	EJE CONFORMAR ANILLAS D90	1
2	125-16-01-00012	PLETINA ANILLA D90 INFERIOR	1
3	125-16-01-00013	PLETINA ANILLA D90 INTERMEDIO	1
4	125-16-01-00014	PLETINA ANILLA D90 SUPERIOR	1
5	020-I7380-M10X30	TORNILLO ALLEN ABOMBADO ISO 7380 M10x30	2

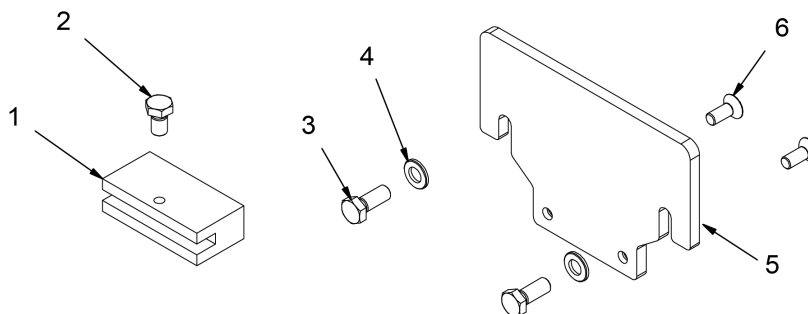

Element	REF	Description	Quant.
1	125-16-01-00017	SOPORTE MATRIZ CONFORMAR ANILLAS PP200	1
2	020-DIN933-M10X20	TORNILLO HEXAGONAL DIN 933 M10X20	1
3	020-DIN933-M12X30	TORNILLO HEXAGONAL DIN 933 M12X30	2
4	020-DIN125B-M12	ARANDELA DIN 125 B M12	2
5	125-16-01-00015	BASE MATRIZ CONFORMAR ANILLAS PP200	1
	020-D7991-M10X25	TORNILLO ALLEN AVELLANADO DIN7991 M10X25	2

Twisted bars forming die

Description

Die to bend metal plate, flat bar or square bar to obtain a nice braid twisted effect. It's very used to make fences and grills

For flat bars from to 6, 12 and 14mm. (For different sizes, please ask the manufacturer)

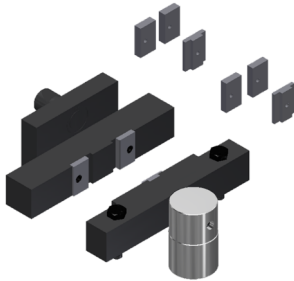

Max. capacity	Cuadradillo de 14mm
Min. capacity	Chapa de 2x40mm
Weight	18Kg
<i>* For different sizes, please ask the manufacturer</i>	

Parts list

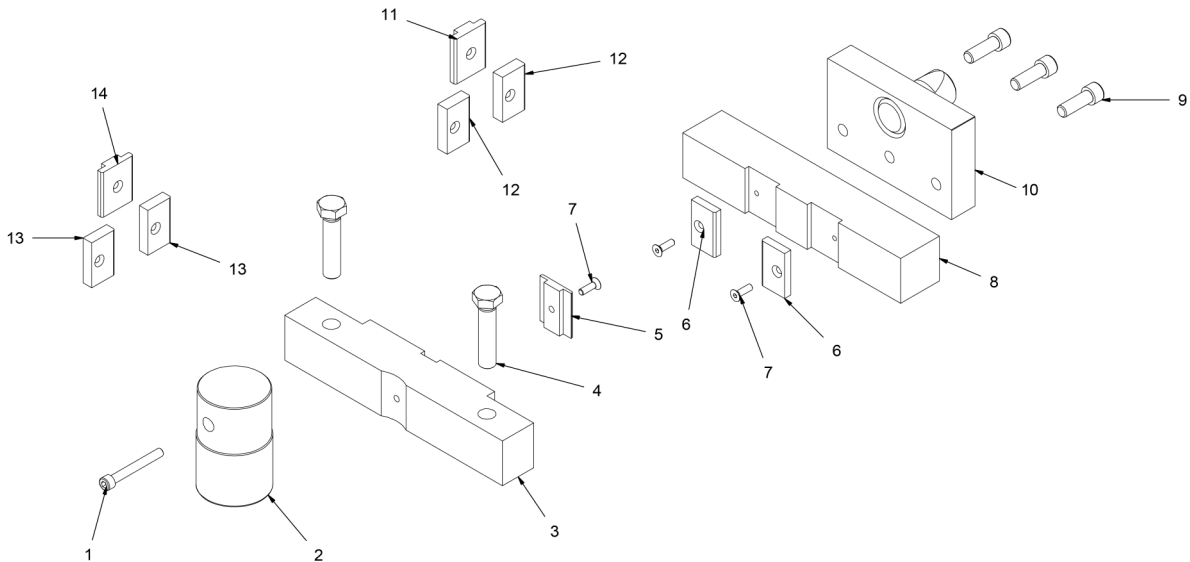

Element	REF	Description	Quant.
1	020-D912-M8X65	Tornillo Allen DIN 912 M8X65	1
2	125-16-01-00074	Centraje Fijo	1
3	125-16-01-00073	Soporte Fijo 50x50	1
4	020-D933-M16X70	Tornillo Hexagonal DIN 933 M16x70	2
5	125-16-01-00072	Postizo Central Para Pletina 6	1
6	125-16-01-00071	Postizos Laterales Para Pletina 6	2
7	020-D7991-M6X20	Tornillo Allen DIN 7991 M6X20	3
8	125-16-01-00070	Soporte Movil 50x50	1
9	020-D912-M12X35	Tornillo Allen DIN 912 M12X35	3
10	131-16-01-00023	Anclaje Posterior	1
11	125-16-01-00125	Postizo Central Para Pletina 14	1
12	125-16-01-00126	Postizos Laterales Para Pletina 14	2
13	125-16-01-00124	Postizos Laterales Para Pletina 12	2
14	125-16-01-00123	Postizo Central Para Pletina 12	1

Promecampunch holder

Description

Punch holder for all kind of punches for Promecam bending or folding press.

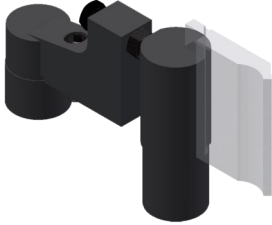

Max. Folding lenght	150 mm
Weight	14Kg

Compatible with any Promecam punch

Parts list

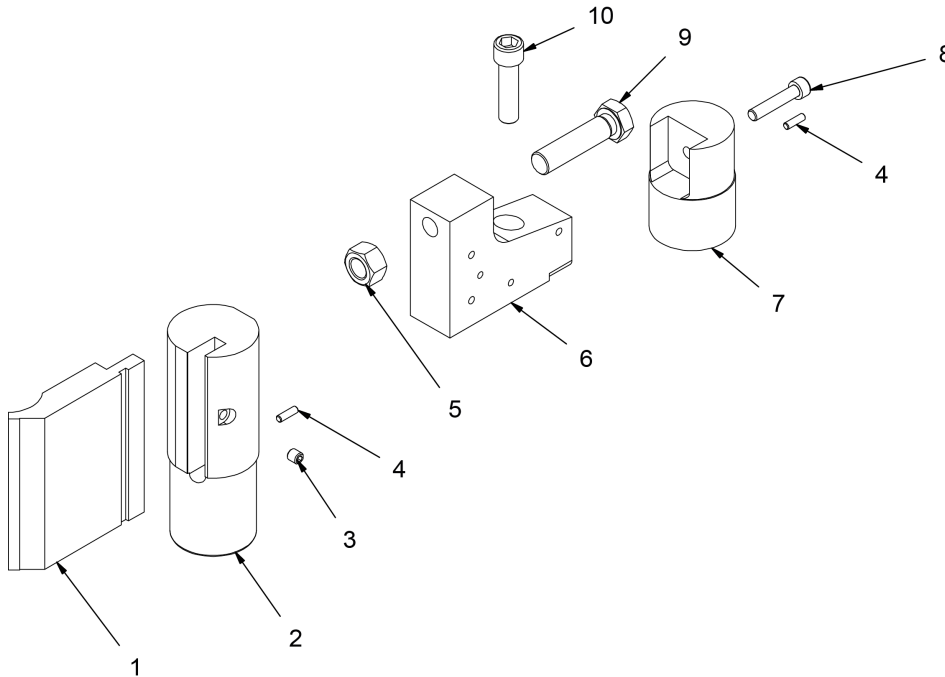

Element	REF	Description	Quant.
1	PUNZON 120	PUNZON PROMECAM 10_00 88 835	1
2	125-16-01-00021	Portapunzones Promecam	1
3	020-D913-M10X10	ESPARRAGO ALLEN DIN 913 M10X10	1
4	020-D913-M6X20	ESPARRAGO ALLEN DIN 913 M6X20	2
5	020-D934-M20	TUERCA DIN 934 M20	1
6	125-16-01-00131	Soporte Posterior	1
7	125-16-01-00130	Guia D70 Soporte Posterior	1
8	020-D912-M10X50	TORNILLO ALLEN DIN 912 M10X50	1
9	125-16-01-00132	Tornillo Regulador Refrentado	1
10	020-D912-M16X60	TORNILLO ALLEN DIN 912 M16X60	1

Bar clamps forming die

Description

Matriz para fabricar las grapas utilizadas para unir diferentes barrotes de forja sin necesidad de soldadura.

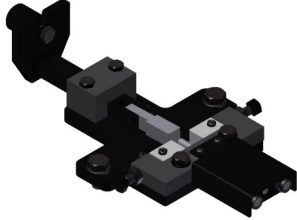

Max. capacity	25x5 mm
Weight	9 Kg

Parts list

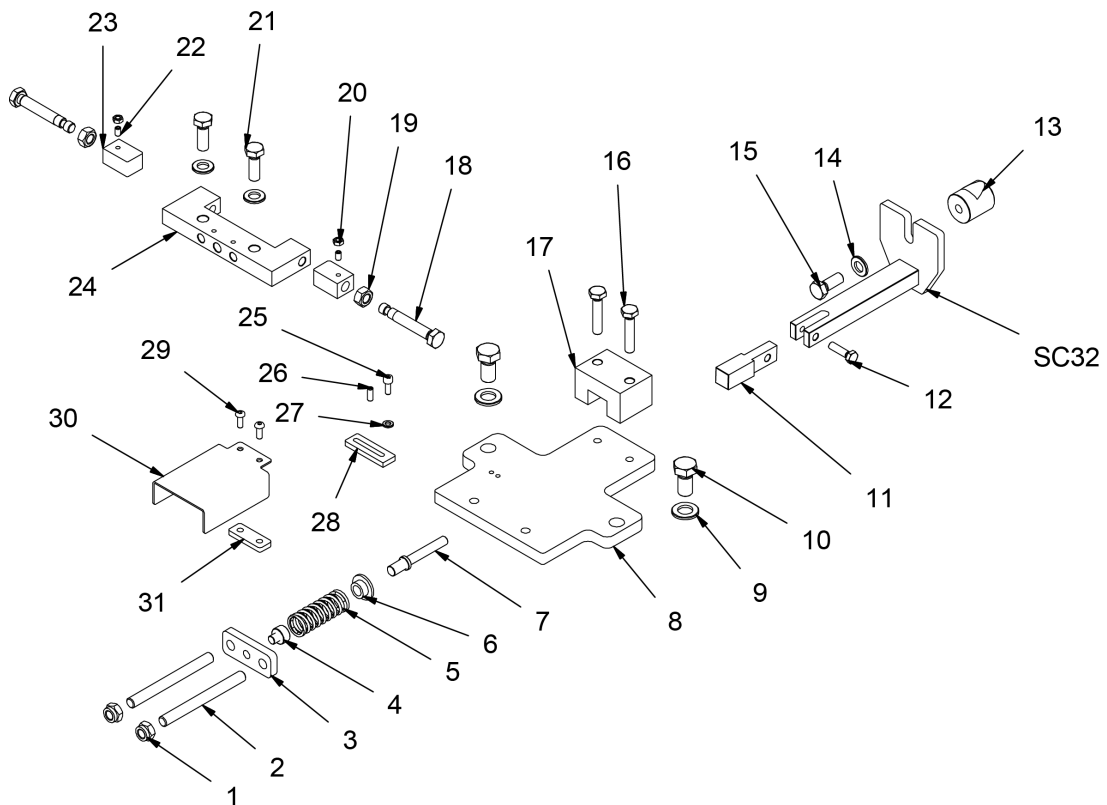

Element	REF	Description	Quant.
1	020-D985-M12	Tuerca Autoblocante DIN 985 M12	2
2	125-16-01-00144	Varilla Roscada Muelle	2
3	125-16-01-00143	Soporte Trasero Muelle	1
4	125-16-01-00146	Centraje Muelle	1
5	125-16-01-00145	Muelle Compresion Di20xDe26 Paso 9mm 9 Espiras Finales Planos	1
6	125-16-01-00136	Arandela Muelle	1
7	125-16-01-00135	Eje Extractor	1
8	125-16-01-00132	Placa Base Util	1
9	020-D125B-M16	Arandela Biselada DIN125B Para M16	2
10	020-D933-M16X30	Tornillo Hexagonal DIN 933 M16x30	2
11	125-16-01-00137	Cuadrado Empuje 20x20	1
12	020-D933-M8X30	Tornillo Hexagonal DIN 933 M8x30	1
13	125-16-01-00141	Eje Centrador	1
14	020-D125B-M12	Arandela DIN 125 B M12	3
15	020-D933-M12X30	Tornillo Hexagonal DIN 933 M12x30	1
16	020-D933-M10X50	Tornillo Hexagonal DIN 933 M10x50	2
17	125-16-01-00138	Cuadrado Guia Entrada	1
18	125-16-01-00147	Tornillo Regulacion	2
19	020-D934-M12	Tuerca DIN 934 M12	2
20	020-D934-M6	Tuerca DIN 934 M6	2
21	020-D933-M12X35	Tornillo Hexagonal DIN 933 M12x35	2
22	020-D913-M6X10	Esparrago DIN 913 M6x10	2
23	125-16-01-00134	Grapa Movil	2
24	125-16-01-00133	Cuerpo Util Grapas	1
25	020-D912-M6X16	Tornillo Allen DIN 912 M6x16	1
26	020-D913-M6X16	Esparrago Allen DIN 913 M6x16	1
27	020-D125B-M6	Arandela Biselada DIN125B para M6	1
28	125-16-01-00142	Tope Lateral Util	1
29	020-I7380-M6X16	Tornillo Allen ISO 7380 M6x16 8.8 Pavonado	2
30	125-16-01-00148	Tapa Trasera	1
31	125-16-01-00149	Sepador Tapa Trasera	1
SC32	131-16-01-00043	Conjunto Arrastre Util Grapas	1

OUR RANGE OF MACHINERY



IRON WORKERS



SECTION BENDING



NON-MANDREL



HORIZONTAL PRESS



TWISTING/SCROLL



HYDRAULIC PRESS



HYDRAULIC SHEAR



GAS FORGES



IRON EMBOSSING



END WROUGHT IRON



BROACHING



POWER HAMMERS



HYDRAULIC FORGING PRESS