

IRONWORKER MACHINE

MX700

NS: 2021-283

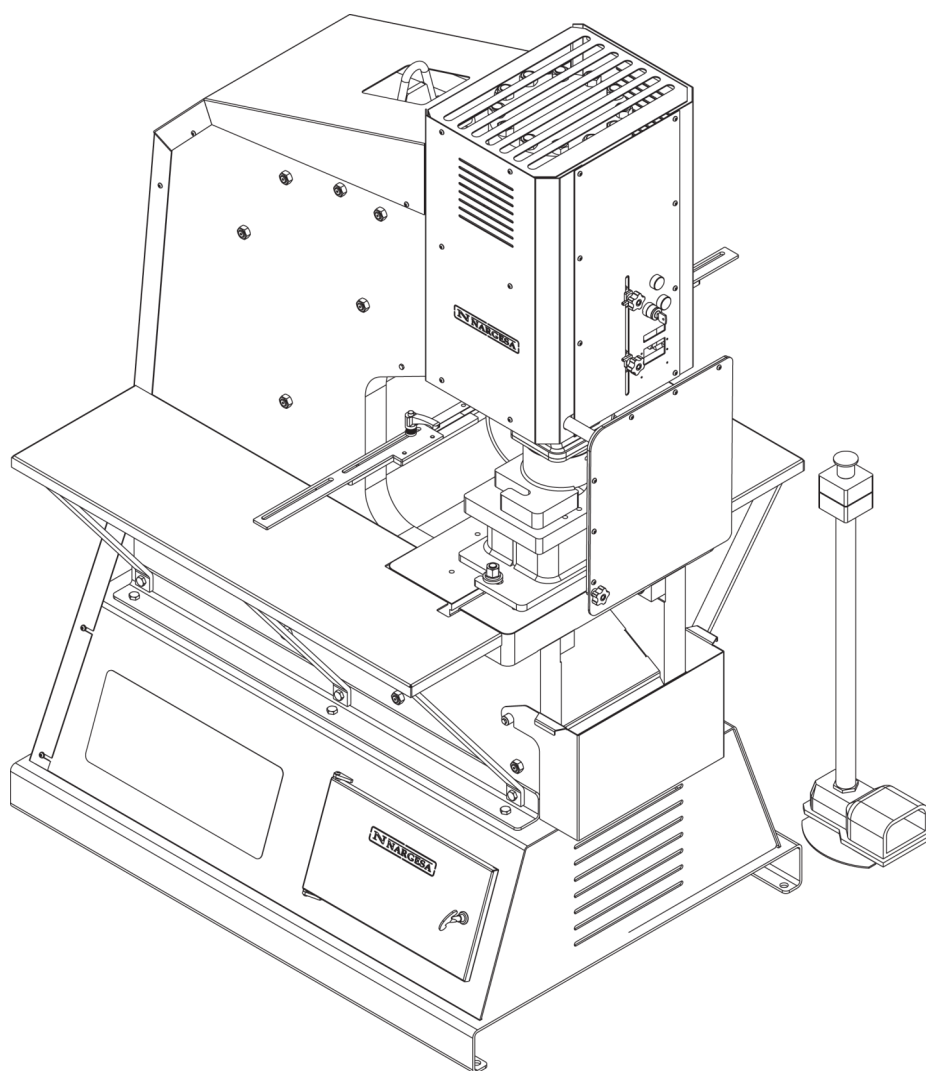

INSTRUCTIONS BOOK

PRADA NARGESA, S.L

Ctra. de Garrigàs a Sant Miquel s/n · 17476 Palau de Santa Eulàlia (Girona) SPAIN

Tel. +34 972568085 · nargesa@nargesa.com · www.nargesa.com

Thank you for choosing our machines



www.nargesa.com

INDEX

FEATURES OF THE MACHINE	3
1.1. General dimensions	3
1.2. Description of the machine	3
1.3. Identification of the machine	4
1.4. General characteristics	5
1.5. Description of safety devices	5
2. TRANSPORT AND STORAGE	6
2.1. Transport	6
2.2. Storage conditions	6
3. MAINTENANCE	7
3.1. General maintenance	7
4. INSTALLMENT AND STARTING UP	8
4.1. Location of the machine	8
4.2. Dimensions and working site	8
4.3. Admissible outer conditions	8
4.4. Connection to power supply	9
5. OPERATION MANUAL	10
5.1. Introduction	11
5.2. Feeding up of MX700	11
5.3. Activation of the machine	11
5.4. Working at manual mode	12
5.5. Working at automatic mode	12
5.6. Meter deletion	13
5.7. Desactivation of the machine	14
5.8. Unusual performance situations	14
6. WARNINGS	16
7. ACCESSORIES	18

TECHNICAL ANNEX

1. FEATURES OF THE MACHINE

1.1. General dimensions

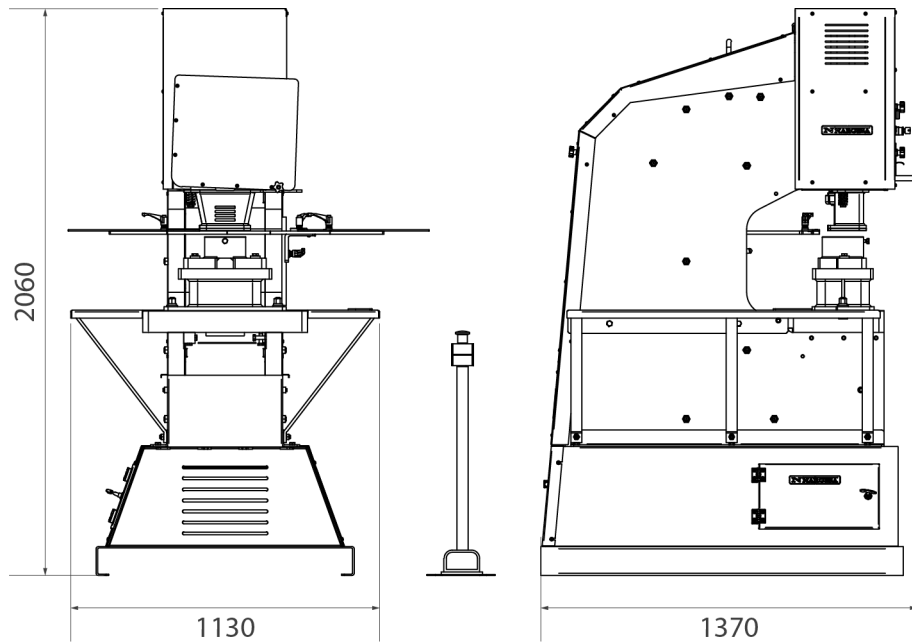

1.2. Description of the machine

The MX700, has been especially designed for punching metal parts with different shapes depending on the type of punch.

It may have other utilities by incorporating various accessories. It may be used for other purposes but always following the manufacturer's guidelines, which provide all dockable accessories to the machine.

MX700 is made according to the European regulations for the manufacturing of industrial machinery

1.3. Identification of the machine

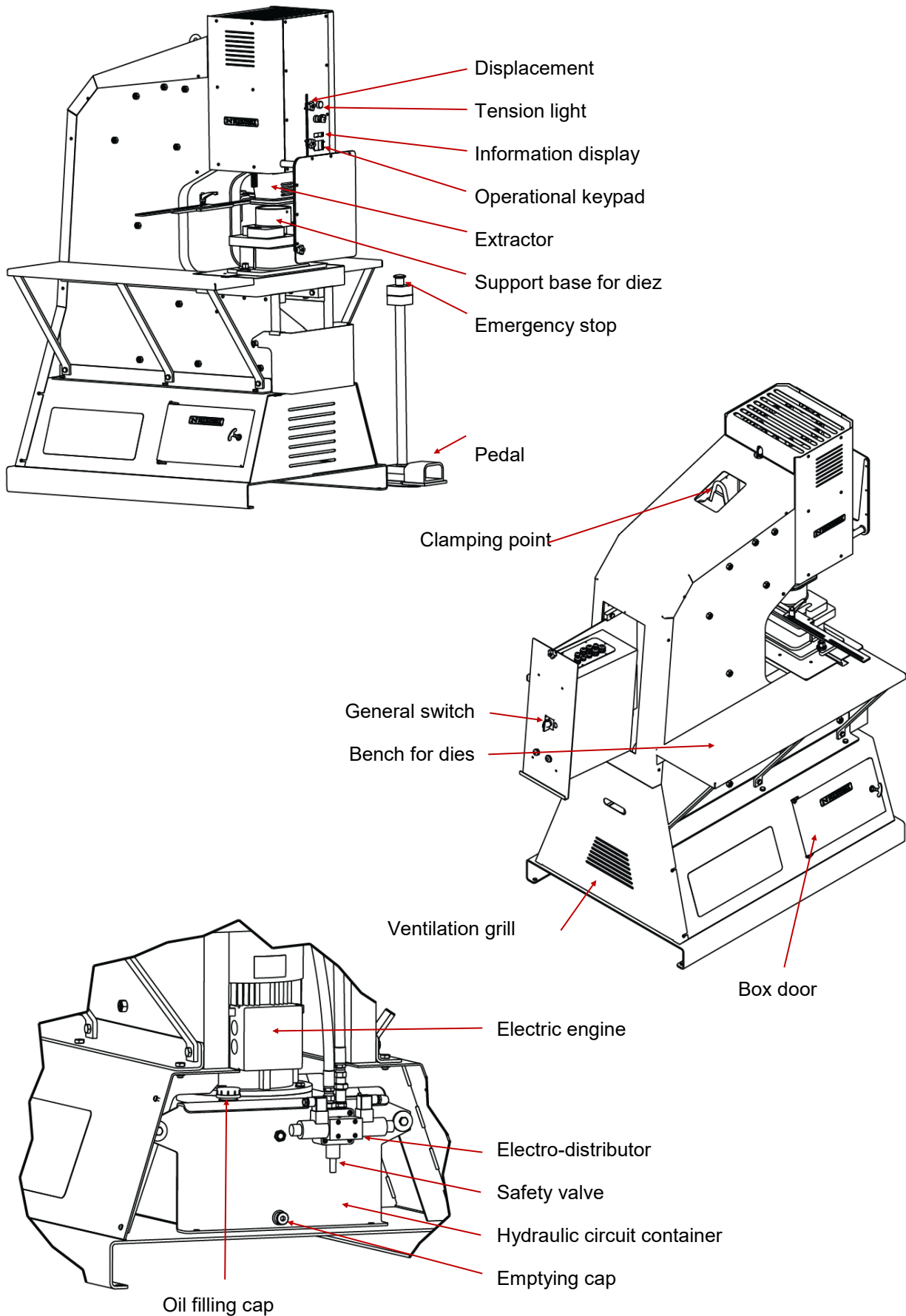



1.4. General characteristics

Engine power	5,5 KW / 7,5 HP
Tension	230/400V Three-Phase 230V Single-Phase
Hydraulic power	70 Tn
Working speed	9 mm/s
Return speed	14 mm/s
Punch displacement	160 mm
Neck	350 mm
Tooling support table	600x350 mm
Dimensions	1130x1370x2060 mm
Weight	2000 Kg

1.5. Description of safety devices

Protection devices of the MX700 are the extractor at the front of the machine to hold the material and avoid putting your hands between the punch and the workpiece.

It also has a screen to prevent fragments projections, this display has a security system to prevent the punch from descending if the screen is raised, only if the key to cancel safety is turned, then it could be possible to work with with the hazard light. Picture 2

Picture 1

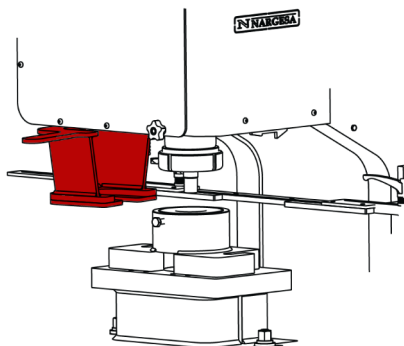

Picture 2

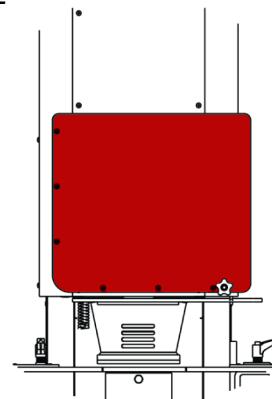

2. TRANSPORT AND STORAGE

2.1. Transport

There are two ways of carrying out the transportation of the machine.

One of them is lifting it by its lower part using a forklifting truck as indicated in picture 3 and the other one is by using a crane or forklifting truck as well and grabbing it by the clamping spot on the upper side, as indicated in picture 4.

Picture 3

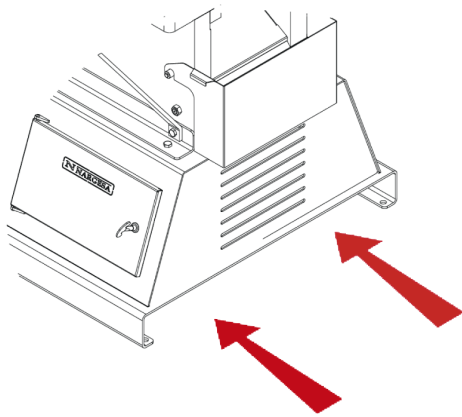

Picture 4

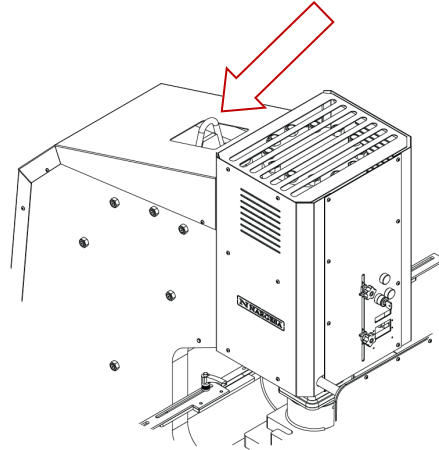

2.2. Storage conditions

The punch can never be stored in a place where it does not meet the following requirements:

- * Humidity 30% to 95% non-condensing.
- * Temperature -25 to 55 ° C or 75 ° C for periods not exceeding 24 hours (remember that these temperatures are in storage)
- * It is advisable not to stack heavy objects or machines.
- * Do not disassemble for storage.

3. MAINTENANCE

3.1. General maintenance

Every 500 hours of use, check the oil level in the tank.

At the top of the tank is the oil plug. In case you need to add oil, fill to cover the peephole in the front of the tank. (Picture 5)

- Replace every 2000 hours or every 5 years the hydraulic oil tank. Oil Type: CEPESA HYDRAULIC HM 68. The tank has a capacity of 60 liters

Picture 5

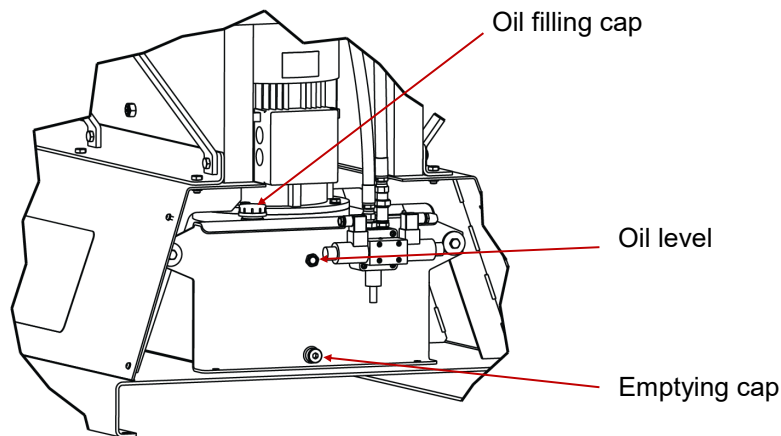

WARNING:

Stop the machine and press the emergency stop to perform the oil change.

After replacing the oil, put up the machine and press the pedal in intermitencies increasing time pressure gradually until the circuit fill up. Make sure the machine will perform normally.

- Lubricate punches periodically depending on use.
- If the use is daily and continuous, grease them every day.
- If the use is sporadic during the day then oil each week.
- If the use is sporadic, grease once a month.

Picture 6

1- Stop the machine

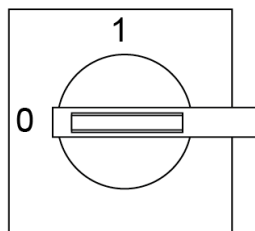

4. INSTALLMENT AND STARTING UP

4.1. Location of the machine

Efforts will be made to locate the machine properly to avoid having to move, otherwise the user must follow the guidelines described in section transport (n°2). It should be placed on a flat, level surface to prevent vibration and movement of the joint while performing. It is possible to fix the machine by bolts as is provided with a lower base or foot with four holes as shown in Picture 7.

Picture 7

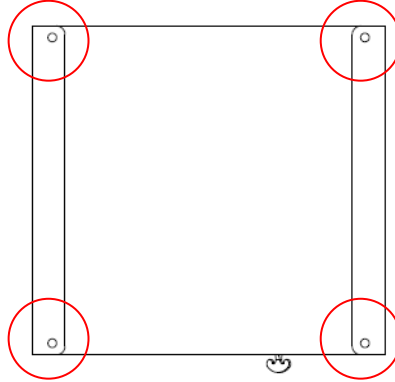

4.2. Dimensions and working site

When the machine is placed on site its dimensions, the workspace of the operator and the possible lengths of the workpiece are to be taken into account.

The machine must be used by a single operator, which is to be placed frontally to the machine, never in a lateral area because he has to control the whole machine and also main protections are designed to use the front of it.

Picture 8

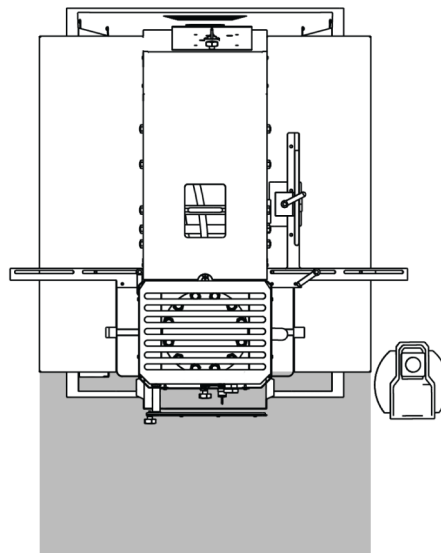

4.3. Admissible outer conditions

- Temperature between +5°C and +40°C without exceeding an average temperature of +35°C during 24h
- Humidity between 30% and 90% with no water condensation.

4.4 Connection to power supply

IMPORTANT: This machine must be connected to a single outlet with earthing

The MX700 is equipped with a three phased engine 230V / 400V with 5,5Kw connected on a star shape to connect into a power supply of 400V. It should be connected to an only power supply with the indicated requirements. If the line tension is not the indicated one then there must be carried out a change of connection of the motor bobins and the inverter as indicated in the following pictures:

Picture 9

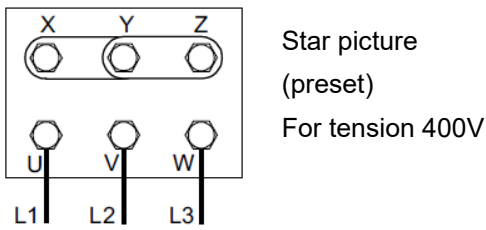

Picture 10

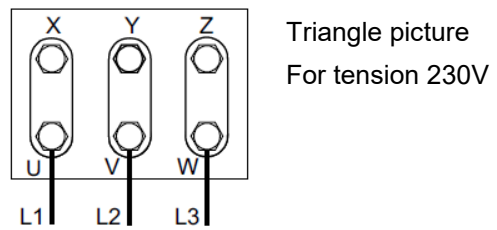

In case of change of tension from 400V to 230V, change terminal 6 from 400V and put it in terminal 230V.

Picture 11

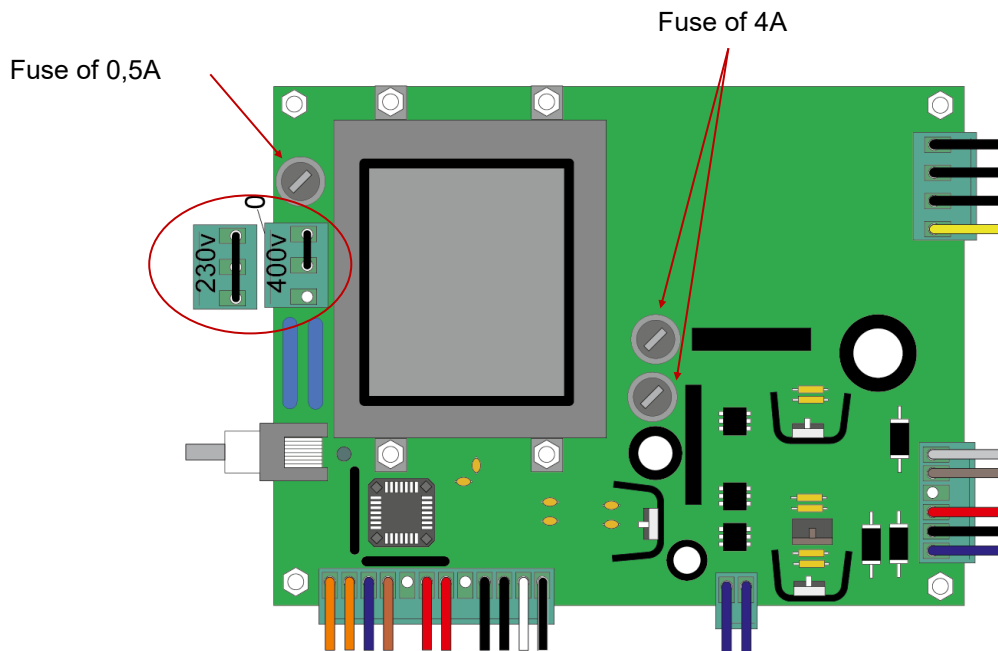

5. OPERATION MANUAL

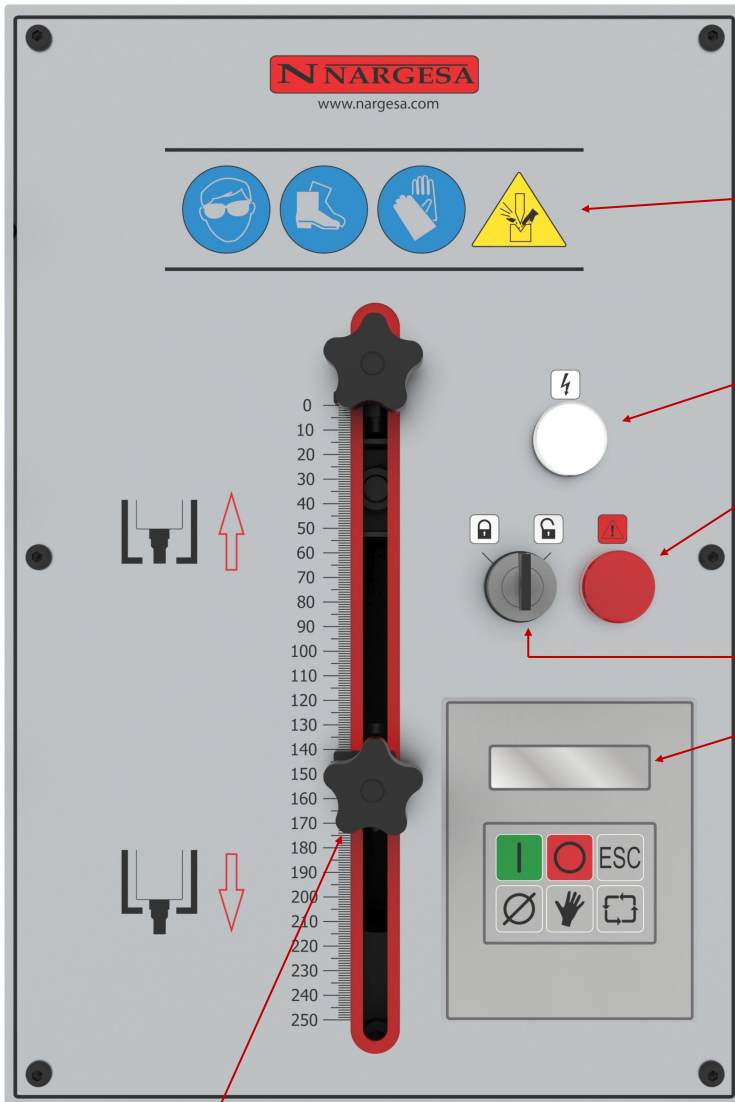

Compulsory safety devices when using the MX700

Tension light

Safety cancelling light

Key of cancelling safety screen

Control screen

Wing for setting the lower and upper limits stop the punch.



ON key for starting up the machine



OFF key to stop the machine

ESC

Key for cancelling one operation



Key for deleting the counter of punching operations



Key for turning on to manual mode



Key for changing on to automatic mode

5.1. Introduction

This manual is intended to be useful to the user of the MX700, as it contains important information about the use and features of the machine. It is for this reason that it is recommended to follow step by step the points in this manual in order to understand the correct operation of the machine.

5.2. Feeding up of MX700

To give power to the machine, put the March switch in the Connected position. When proceeding, a message like this will be displayed

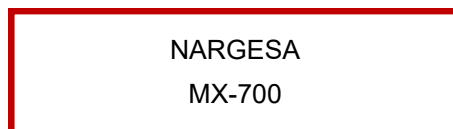

Picture 12. Message for activation of the Hydraulic Press

The situation in which the punching machine is currently called StandBy, a state in which the machine is turned on but remains idle waiting to perform any function.

5.3. Activation of the machine

With the machine already initialized and in StandBy, you can work with it by following the steps detailed below.

To proceed properly, please press the ON key. When doing so, it will appear on the display LCD messages like this.

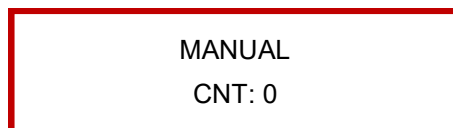

Picture 13. Message of activated Hydraulic Pres

The information represented in the picture above shows, in the top row of the LCD display, the current mode of punching (Manual or Automatic). In the bottom row there is the counter which is incremented each time the pedal is pressed down.

5.4. Working at manual mode

In MANUAL mode, the way we work is as follows. Press the pedal to make the punching operation. By proceeding as described here, see how the counter of the machine shown in the LCD display will be increased in one piece.

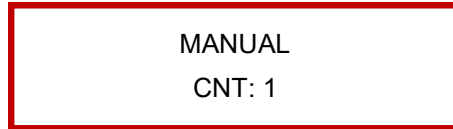

Picture 14. Information about manual punching

Picture 14 shows how the counter now dial 1 punching operation. Once it is complete you can lift off the foot the pedal.

You should note that this mode of operation allows you to go by descending the rod slowly as you have more or less time down on the pedal. Upon reaching the inductive Lower displacement or when you lift your foot off the pedal , stem movement stops.

Considering this mode of operation, you can adjust the setting of the Lower inductive to regulate the stem descention while pressing the pedal , so you can be seeing as the machine continued its going down until said inductive limit switch is activated.

Finally, it is important to remember that in this mode the punching rod moves ever upward , so that if you need this up, shall proceed as detailed in the following section.

5.5. Working at automatic mode

To switch from work mode MANUAL into AUTOMATIC work mode, all you have to do is press the AUTO key. When doing so, the stem is activated in ascending displacement. This movement continues until the machine has reached the Stroke. Moreover, the automatic mode is quite close to the one mentioned in section 6.4. However, as there are some differences, let's take a look at them:

Press the pedal to punch. By proceeding as described here, see how the counter on the machine shown in the LCD display will be incremented by one.

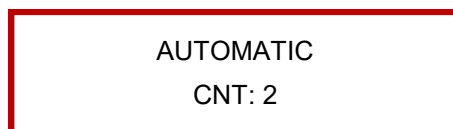

Picture 15. Information of the Automatic Punching

Once that punching is complete, you can lift the foot off the pedal. However, in this mode of operation, unlike the above, the piston rod returns back to its rest position, starting the climb to the Superior FC is activated.

You should note that this mode also allows you to go work by lowering the rod slowly to adjust the descent, by positioning the Lower inductive. Whenever you hold the pedal rod takes a downward movement will be stopped only when the above inductive I Final Race is activated. When you lift your foot off the pedal, the rod movement reverses and begins the ascent.

5.6. Meter deletion

The MX700 has a counter as you know, if you have carefully read the foregoing sections. This can be very favorable in case you need to count the punching operations, this requires a certain part, or the ones a third user has made with your machine a third part with your machine.

Obviously this counter can be deleted. In order to proceed properly and supposing it shows up on the LCD a message like this one below in which for example, you have done 150 operations, just follow the instructions indicated below.

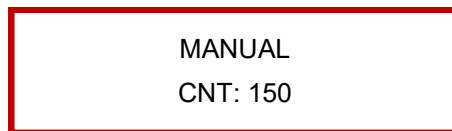

Picture 16. Information of the number of operations made

It is important to say that the counter can be always erased whenever the machine is about to work (in state of StandBy it is not possible), but without performing any operation, the user may proceed thus, in MANUAL mode or AUTO mode.

The only thing you should do is press the COUNTER key. If it does, the message shown on the LCD will change to this one.

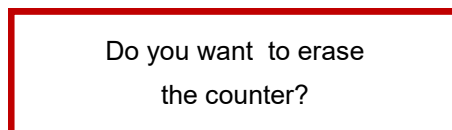

Picture 17. Message with the information of the counter deletion

Logically, if you press the ESCAPE key, the counter will not be affected, and return to the previous screen. If instead you want to clear the counter to the question put to him in the previous message, press the COUNTER key again. The new message is displayed like this on screen.

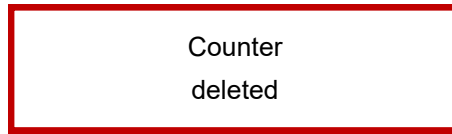

Picture 18. Information of the deleted counte

5.7. Desactivation of the machine

At any time the machine is turned on and it's on rest position, you can turn it off. If this is what you want, please press the OFF button and the machine will be disabled, going to standby (refer to Section 6.2)

5.8. Unusual performance situations

At any time an abnormal operating condition, a situation which by its description implies the stop of any operation that was performed at that time may occur.

Abnormal situations are divided into two groups, the Emergency Situations and Error. The specific situations that lead to each of these two groups are shown below

Emergency:

Activating the Emergency Stop button



Picture 19. Information about Emergency Stop

Error situations:

Error on the Upper Displacement of the machine.

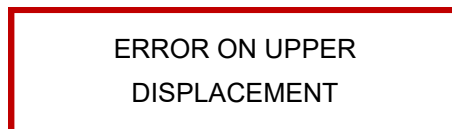

Picture 20. Information about Error on the upper Displacement

Error on lower displacement



Picture 21. Information of Error on Lower displacement

Thus, the result of the situations mentioned above, the MX700 goes into such a state that aborts any operation being performed at that time, indicating on screen the anomalous situation that has occurred message.

For security reasons the new activation of the punching machine is not allowed until you have removed the abnormal situation. In case of Emergency can solve this anomalous situation by restoring the Emergency Stop button. Once solved the corresponding anomalous situation, the punching machine restarts and enters standby mode (for later activation refer to paragraph 6.3. Activation of MX700).

If an error situation occurs, with intent to prevent further damage or dangerous situations for users, the punching machine is locked, screen showing the relevant message. In this case, you can only unlock the machine by disconnecting the voltage, and then reconnecting it again. However, at the occurrence of any error conditions, please do not hesitate to contact Technical Support and effect so that the problem will be solved as soon as possible.

6. WARNINGS

The MX700 is equipped with a safety screen to prevent projected elements from causing any damage to the machine operator. This screen can only be raised for the preparation of tools, dies or punches, the machine can operate whenever the key is in "ON" position, this key is always to be controlled by the person responsible for the section or area in which the machine is located.

When the key is set to "On" a red light warning lights on the front indicating that security is bypassed.

- Do not touch any part of the machine running.
- Do not use the machine for other purposes but the ones described in this manual.
- Use gloves when handling and machine components during punching processes
- Wear safety glasses and protective boots approved by the EC.
- Hold the material at the ends, never by the part of the punching.
- Do not work without the protections fitted to the machine. (Never punch without the extractor)
- Maintain a safe distance between the machine and the operator during the time the machine is running.
- Do not use punches or tooling that are not provided by Nargesa.
- The tools to be attached to the machine must always be attached to the base and the piston.
- In case of accident by negligence of the operator, not to follow the safety and operating standards set out in the handbook NARGESA will not take any responsibility.

WARNING

No parts can never put that can not be supporting both sides of the EXTRACTOR, nor extremely narrow and flexible parts could be punched, as there is a risk they can fold towards the extractor

- Do not punch parts that cannot stand symmetrically supported on the extractor.
- do not punch the part if it doesn't stand on both sides of the extractor.

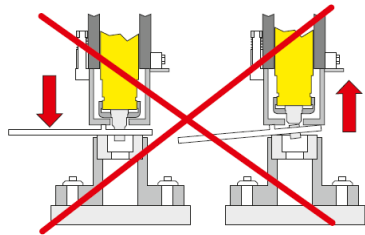

When going backwards
the punch will break down

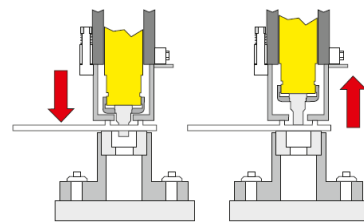

When going backward,
the correct extraction is

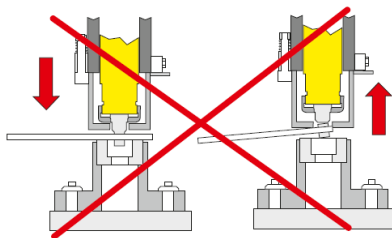

When going backwards
the punch will break down

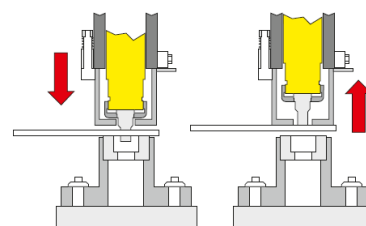

When going backward,
the correct extraction is

7. ACCESSOIRES

The main element for which the machine has been designed is the punch. The punch and base are treated, which ensure their reliability and strength in normal use. Punches and their bases have different sizes and shapes (round, square, rectangular, oblong). There are also other accessories or dies coupled to the piston to cut, bend pipe, blunt, folding, etc.

The MX700, has got a wide range of punches and dies which allows to make all kinds of jobs such as folding, punching, cutting, etc.

All Nargesa Hydraulic Punching Machines are equipped with the punching tool that include the fitting nut for punches and the base holder for dies. The rest of accesories are optional, which means each customer equips his machine as desired.

Dimensions calculated with material of 45Kg



Material thickness	Round punch	Square punch
25mm	26mm	19mm
10mm	60mm	47mm
8mm	70 mm	55mm
5mm	100mm	70mm

Fitting nuts for punches MX700

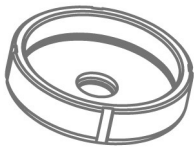

TAP

Type	Fitting nuts for punches
TAP28	Fitting nuts for punches N28 <i>Standard</i>
TAP40	Fitting nuts for punches N40
TAP50	Fitting nuts for punches N50
TAP60	Fitting nuts for punches N60
TAP75	Fitting nuts for punches N75
TAP100	Fitting nuts for punches N100
ATAP	Fitting part for TAP100



ATAP

Fitting parts for dies MX700

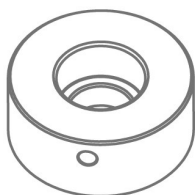

CAB

Type	Fitting for dies
N46	Fitting for dies N46 <i>Standard</i>
N60	Fitting for dies N60
N78	Fitting for dies N78
N85	Fitting for dies N85
N100	Base holder for dies N100
N125	Base holder for dies N125

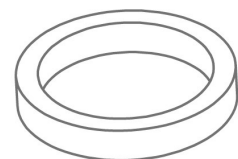

CAB N125

Standard round punches MX700

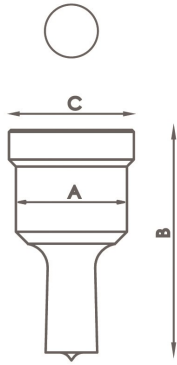

Type	Available sizes in mm Ø	A	B	C
N28	3/3'5/4/4'5/5/5'5/6/6'5/7/7'5/8/8'5 9mm up to 28mm de 0'5 in 0'5mm	28 mm	58 mm	31,5 mm
N40	29/30/31/32/33/34/35/36/37/38/39/40mm	40 mm	64 mm	43,5 mm
N50	41/42/43/44/45/46/47/48/49/50mm	50 mm	58 mm	54 mm
N60	52/54/56/58/60mm	60 mm	58 mm	64 mm
N75	62/64/66/68/70/72/74mm	75 mm	58 mm	79 mm
N100	76/78/80/82/84/86/88/90/92/94/96/98/100mm	100 mm	58 mm	104 mm

For different sizes, please ask the manufacturer.

Standard square punches MX700

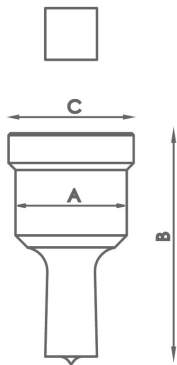

Type	Available sizes in mm Ø	A	B	C
N28	4/5/6/7/8/9/10/11/12/13/14/15/16/17/18/19/20mm	28 mm	58 mm	31,5 mm
N40	21/22/24/26/28mm	40 mm	64 mm	43,5 mm
N50	31/33/35mm	50 mm	58 mm	54 mm
N75	40/44/48/53mm	75 mm	58 mm	79 mm
N100	58/64/70mm	100 mm	58 mm	104 mm

For different sizes, please ask the manufacturer.

Standard rectangular punches MX700

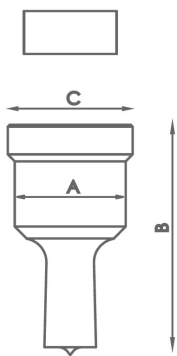

Type	Available sizes in mm Ø	A	B	C
N28	7x10/7x15/9x13/9x19/11x17/11x23 13x19/15x21mm	28 mm	58 mm	31,5 mm
N40	13x25/15x27/17x25/19x30/20x34mm	40 mm	64 mm	43,5 mm
N50	25x43mm	50 mm	58 mm	54 mm
N75	25x70mm	75 mm	58 mm	79 mm
N100	25x96mm	100 mm	58 mm	104 mm

For different sizes, please ask the manufacturer.

Standard oval punches MX700

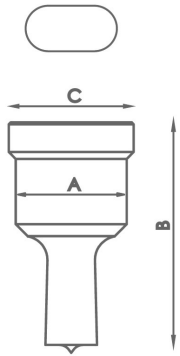

Type	Available sizes in mm Ø	A	B	C
N28	7x10/7x15/7x20/9x13/9x19/11x17/11x23/13x18 13x22/13x27/15x20/15x24/15x27/17x22/17x26 19x26/21x27mm	28 mm	58 mm	31,5 mm
N40	13x31/15x31/17x31/17x40/19x31	40 mm	64 mm	43,5 mm
N50	25x45/25x50mm	50 mm	58 mm	54 mm
N75	27x63/27x75mm	75 mm	58 mm	79 mm
N100	30x87/30x100mm	100 mm	58 mm	104 mm

For different sizes, please ask the manufacturer.

Standard round dies MX700

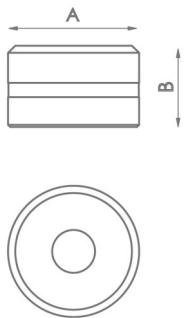

Type	Available sizes in mm	A	B
N46	3/3,5/4/4,5/5/5,5/6/6,5/7/7,5/8/8,5 9mm up to 28mm de 0,5 en 0,5mm	46 mm	28,5 mm
N60	29/30/31/32/33/34/35/36/37/38/39/40mm	60 mm	32 mm
N78	41/42/43/44/45/46/47/48/49/50mm	78 mm	28,5 mm
N100	52/54/56/58/60/62/64/66/68/70/72/74mm	100 mm	28,5 mm
N125	76/78/80/82/84/86/88/90/92/94/96/98/100mm	125 mm	28,5 mm

For different sizes, please ask the manufacturers.

Standard square dies MX700

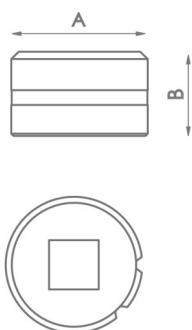

Type	Available sizes in mm	A	B
N46	4/5/6/7/8/9/10/11/12/13/14/15/16/17/18/19/20mm	46 mm	28,5 mm
N60	21/22/24/26/28mm	60 mm	32 mm
N78	31/33/35mm	78 mm	28,5 mm
N100	40/44/48/53mm	100 mm	28,5 mm
N125	58/64/70mm	125 mm	28,5 mm

For different sizes, please ask the manufacturers.

Standard rectangular dies MX700

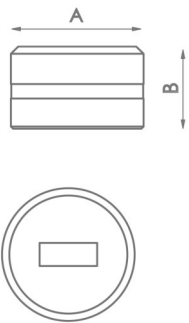

Type	Available sizes in mm	A	B
N46	7x10/7x15/9x13/9x19/11x17/11x23/13x19/13x25/ 15x21mm	46 mm	28,5 mm
N60	15x27/17x25/19x30/20x34mm	60 mm	32 mm
N78	25x43mm	78 mm	28,5 mm
N100	25x70mm	100 mm	28,5 mm
N125	25x96mm	125 mm	28,5 mm

For different sizes, please ask the manufacturers.

Oval dies MX700

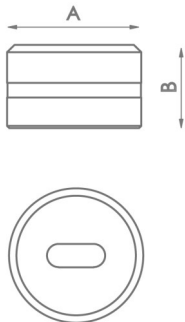

Type	Available sizes in mm	A	B
N46	7x10/7x15/7x20/9x13/9x19/11x17/11x23/13x18/13x22/13x27 15x20/15x24/15x27/17x22/17x26/19x26/21x27mm	46 mm	28,5 mm
N60	13x31/15x31/17x31/17x40/19x31/19x40/21x31/21x40mm	60 mm	32 mm
N78	25x45/25x50mm	78 mm	28,5 mm
N100	27x63/27x75mm	100 mm	28,5 mm
N125	30x87/30x100mm	125 mm	28,5 mm

For different sizes, please ask the manufacturers.

Tube notching tooling MX700

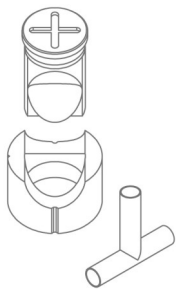

Reference	Available sizes in mm	Required fitting	
MAN28	Tube from 16 to 28mm	TAP 28	CAB 46
MAN40	Tube from 28,5 to 40mm	TAP 40	CAB 60
MAN50	Tube from 40,5 to 50mm	TAP 50	CAB 78
MAN60	Tube from 50,5 to 60mm	TAP 60	CAB 85

For different sizes, please ask the manufacturers.

Corner rounding tooling MX700



Reference	Radius in mm	Required fitting	
MRE28	Radius from 3 to 15mm	TAP 28	CAB 46
MRE40	Radius from 16 to 22mm	TAP 40	CAB 60
MRE50	Radius from 23 to 30mm	TAP 50	CAB 78

For different sizes, please ask the manufacturers.

Flat bar round end tooling R1

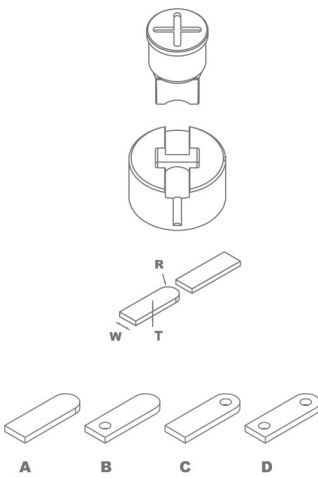

Reference	Model	Width size	Required fitting
MOR1-35A	A	From 20 to 35mm	TAP28 / TAP40
MOR1-35B	B	From 20 to 35mm	TAP28 / TAP40
MOR1-35C	C	From 20 to 35mm	TAP28 / TAP40
MOR1-35D	D	From 20 to 35mm	TAP28 / TAP40
MOR1-50A	A	From 40 to 50mm	TAP50 / TAP60 with ATAP
MOR1-50B	B	From 40 to 50mm	TAP50 / TAP60 with ATAP
MOR1-50C	C	From 40 to 50mm	TAP50 / TAP60 with ATAP
MOR1-50D	D	From 40 to 50mm	TAP50 / TAP60 with ATAP

For different sizes, please ask the manufacturer · When placing order it must be specified the REFERENCE, MODEL, R (radius), W (flat bar width), T (flat bar thickness) · In models B, C and D specify diameter of the hole · The ear shaped legth is always adjustable · Production capacity: 450 to 600 parts per hour.

Flat bar round end tooling R2

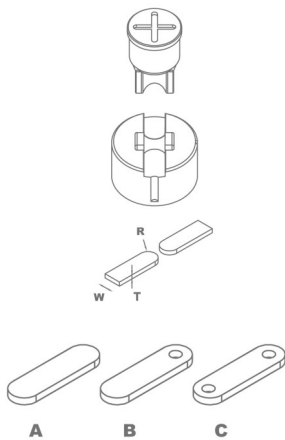

Reference	Model	Width size	Required fitting
MOR2-35A	A	From 20 to 35mm	TAP28 / TAP40
MOR2-35B	B	From 20 to 35mm	TAP28 / TAP40
MOR2-35C	C	From 20 to 35mm	TAP28 / TAP40
MOR2-50A	A	From 40 to 50mm	TAP50 / TAP60 with ATAP
MOR2-50B	B	From 40 to 50mm	TAP50 / TAP60 with ATAP
MOR2-50C	C	From 40 to 50mm	TAP50 / TAP60 with ATAP

For different sizes, please ask the manufacturer · When placing order it must be specified the REFERENCE, MODEL, R (radius), W (flat bar width), T (flat bar thickness) · In models B and C specify hole diameter · The ear shaped legth is always adjustable · Production capacity: 450 to 600 parts per hour.

Stripping Tooling 90° Adjustable 150x150 MX700 · REF. 140-02-02-00001

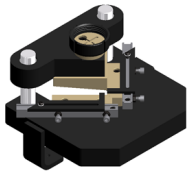

Stripping tooling for metal sheet, angle, etc...Adjustable up to 150x150mm to 90° fixed.

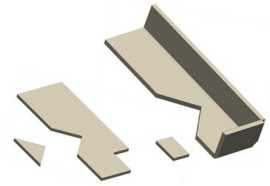

Units per machine	Max. Cutting capacity	Weight
1	150x150x8	38 Kg

Folding Tooling 170mm. MX700 · REF. 140-02-02-00034



Tooling for folding sheet and flat bar up to 170mm. 88° punch. Dies with V for 56mm and V for 26m.

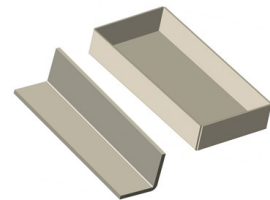

Units per machine	Max. Folding Length	Max. Folding Thickness	Weight
1	170mm	8 a 12mm	13 Kg

Folding Tooling 350mm. MX700 · REF. 140-02-02-00043

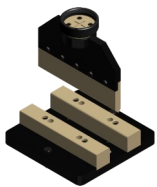

Tooling to fold metal sheet and flat bar up to 350mm. Punch: 88°. Die with adjustable V of 120mm, 80mm, 40mm and 16mm.

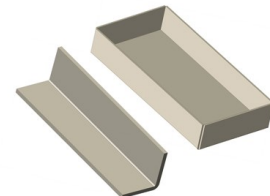

Units per machine	Max. Folding Length	Max. Folding Thickness	Weight
1	350mm	20mm	45 Kg

Ventilation Grip Tooling MX700 · REF. 140-02-02-00031

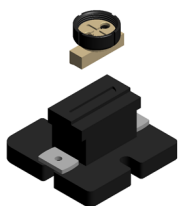

Tooling to make ventilation grips in metal sheet. Adjustable amount of punchings which are to be made one by one.

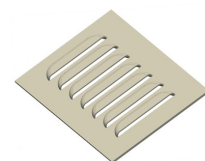

Units per machine	Punching size	Max. Thickness.	Weight
1	100x20mm	2mm	21Kg

Angle Cutting Tooling. MX700 · REF. 140-02-02-00036

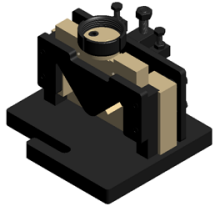

Tooling for cutting angles from 90° up to 45°.

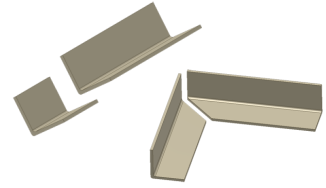

Units per machine	Max cutting capacity Straight cut	Max. Cutting capacity Miter cut	Weight
1	80x80mm	50x50mm	32 Kg

Flat bar Cutting Tooling 100 x 12. MX700 · REF. 140-02-02-00037



Tooling for cutting metal sheet or flat bar from 0.8mm up to 12mm thickness.

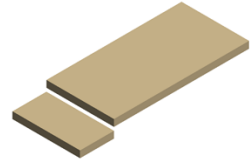

Units per machine	Max. Cutting capacity	Weight
1	100x12mm	29 Kg

Flat Bar Cutting Tooling 200 x 20. MX700 · REF. 140-02-02-00002

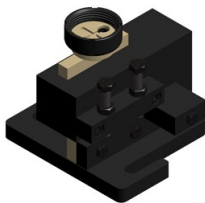

Tooling for cutting flat bar or metal sheet from 0.8mm up to 20mm Thickness.

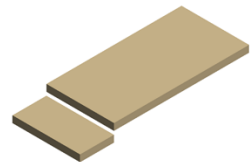

Units per machine	Max. Cutting Capacity	Weight
1	200x20mm	54 Kg

Round Bar Cutting Tooling MX700 · REF. 140-02-02-00038

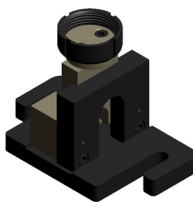

Tooling for cutting round bar from 3mm up to 35mm.

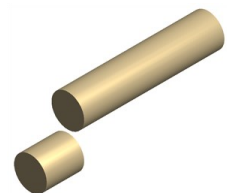

Units per machine	Max. Cutting diameter	Min. Cutting diameter	Weight
1	35mm	3mm	16 Kg

Fence Post End Tooling MX700 · REF 140-02-02-00039

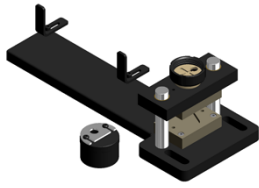

Tooling to flatten and punch the pipe for fences. It admits different pipe diameters. Exchangeable hole size.

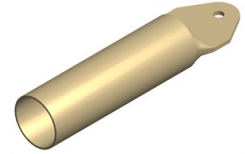

Pieces by tooling	Pipe Max. Diameter	Min. Pipe diameter	Hole Diameter	Weight
2	50mm	10mm	Exchangeable	24 Kg

Arrow Tooling for Pipes MX700 · REF. 140-02-02-00040

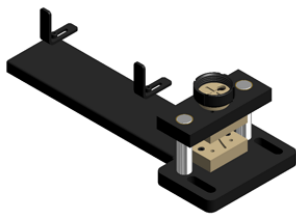

Tooling for flattening and cutting pipes in arrow shapes. Suitable for different diameters.

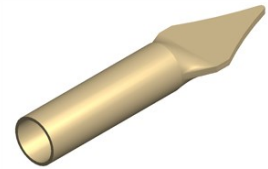

Units per machine	Max. Pipe Diameter	Min. Pipe Diameter	Weight
1	30x2mm	10x2mm	20 Kg

Arrow tooling for Metal Sheet MX700 · REF. 140-02-02-00041



Tooling for punching metal sheet in arrow shapes for fences.



Units per machine	Sheet Max. Thickness	Weight
1	3mm	22 Kg

Angle and U Profile Punching Machine MX700 · REF. 140-02-01-00031

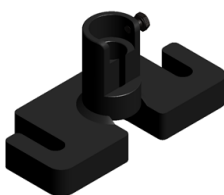

Base holder for punching angles. The punches and dies of different diameters are exchangeable.

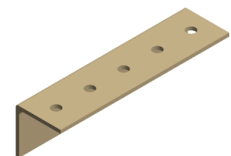

Units per machine	Max. Hole Diameter	Min. Hole Diameter	Weight
1	28mm	2mm	7 Kg

Flattening Tooling MX700 · REF. 140-02-02-00042



It's an extractor which acts as the flat bar holder at the punching time to prevent the flat bar from deformation while being punched.

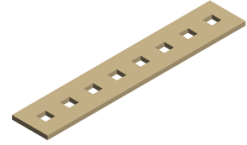

Pieces per tooling	Bar or flat bar max. thickness	Weight
1	15mm	15 Kg

Locks Punch and Die MX700 · REF. 140-02-01-00036



Set of punch and die to make the locks punching in metal sheet.

Necessary complements: CAB60 and TAP40

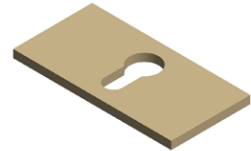

Pieces per set	Max. Thickness	Weight
2	6mm	1 Kg

Set of cutting and shaping die holders for MX700

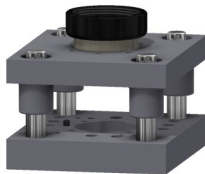

Reference: 140-02-02-00045

Set of die holders to be adapted cutting and shaping tooling for decorative flower elements.

Pieces per set	Weight
2	52,5 Kg

Flower cutting die D65 8 petals MX700

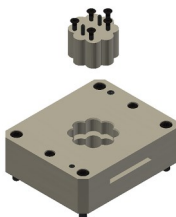

Reference: 140-02-01-00043

Die for cutting 8 petals flower shaped metal sheet, D65mm.

For its use, it is required the die holder for cutting and shaping MX700. Ref. 140-02-02-00045

For any other different designs, ask the manufacturer



Pieces per set	Thickness	Weight
2	1 - 1,5 - 2mm	10,5 Kg

Flower inlaying tooling D65 8 petals MX700

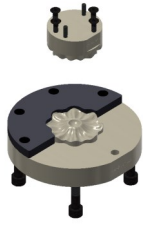

Reference: 140-02-01-00044
 Die for molding 8 petals flower shaped metal sheet, D65mm.
 For its use, it is required the die holder for cutting and shaping MX700. Ref. 140-02-02-00045 and cutting die Ref. 140-02-01-00043
For any other different designs, ask the manufacturer



Pieces per set	Thickness	Weight
2	1 - 1,5 - 2mm	4,9 Kg

Flower cutting die D85 5 petals MX700

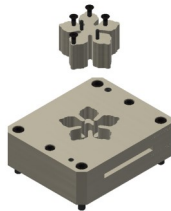

Reference: 140-02-01-00045
 Die for cutting flower shaped metal sheet, 5 petals with diameter 85mm.
 For its use, it is required the die holder for cutting and shaping MX700. Ref. 140-02-02-00045
For any other different designs, ask the manufacturer



Pieces per set	Thickness	Weight
2	1 - 1,5 - 2mm	10,4 Kg

Flower inlaying tool D85 5 petals MX700



Reference: 140-02-01-00046
 Tooling for molding 5 petal flower shaped metal sheet, diameter 85mm.
 For its use, it is required the die holder for cutting and shaping MX700. Ref. 140-02-02-00045 and cutting die Ref. 140-02-01-00045
For any other different designs, ask the manufacturer

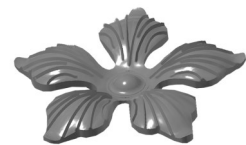

Pieces per set	Thickness	Weight
2	1 - 1,5 - 2mm	6,2 Kg

Leaf cutting die 108X42 MX700

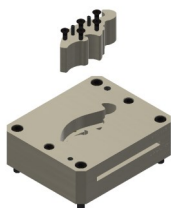

Reference: 140-02-01-00047
 Tooling for cutting leaf shaped, 108x42mm
 For its use, it is required the die holder for cutting and shaping MX700. Ref. 140-02-02-00045
For any other different designs, ask the manufacturer



Pieces per set	Thickness	Weight
2	1 - 1,5 - 2mm	10,2 Kg

Flower inlaying tool 108X42 left MX700

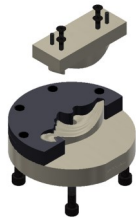

Reference: 140-02-01-00048

Tooling for molding 108x42mm leaf shaped metal sheet, left.

For its use, it is required the die holder for cutting and shaping MX700. Ref. 140-02-02-00045 and cutting die Ref. 140-02-01-00047

For any other different designs, ask the manufacturer



Pieces per set	Thickness	Weight
2	1 - 1,5 - 2mm	6,2 Kg

Leaf inlaying tool 108X42 right MX700



Reference: 140-02-01-00049

Tooling for molding 108x42mm leaf shaped metal sheet, right.

For its use, it is required the die holder for cutting and shaping MX700. Ref. 140-02-02-00045 and cutting die Ref. 140-02-01-00047

For any other different designs, ask the manufacturer



Pieces per set	Thickness	Weight
2	1 - 1,5 - 2mm	6,2 Kg

Serrated-edges leaf cutting die MX700



Reference: 140-02-01-00052

Die for cutting serrated-edges leaf 115x50mm.

For its use, it is required the die holder for cutting and shaping MX700. Ref. 140-02-02-00045

For any other different designs, ask the manufacturer



Pieces per set	Thickness	Weight
2	1 - 1,5 - 2mm	10,2 Kg

Serrated-edges leaf inlaying tool MX700



Reference: 140-02-01-00055

Tooling for molding serrated-edges leaf 115x50mm.

For its use, it is required the die holder for cutting and shaping MX700. Ref. 140-02-02-00045 and cutting die Ref. 140-02-01-00052

For any other different designs, ask the manufacturer



Pieces per set	Thickness	Weight
2	1 - 1,5 - 2mm	16,4 Kg

Bifoliate leaf cutting die MX700



Reference: 140-02-01-00051

Die for cutting bifoliate leaf shaped 70x65mm.
For its use, it is required the die holder for cutting and shaping MX700. Ref. 140-02-02-00045
For any other different designs, ask the manufacturer



Pieces per set	Thickness	Weight
2	1 - 1,5 - 2mm	10,5 Kg

Bifoliate leaf inlaying tool right MX700



Reference: 140-02-01-00053

Tooling for molding bifoliate leaf 70x65mm, right.
For its use, it is required the die holder for cutting and shaping MX700. Ref. 140-02-02-00045 and cutting die Ref. 140-02-01-00051
For any other different designs, ask the manufacturer



Pieces per set	Thickness	Weight
2	1 - 1,5 - 2mm	17,3 Kg

Bifoliate leaf inlaying tool right left MX700



Reference: 140-02-01-00054

Tooling for molding bifoliate leaf 70x65mm, left.
For its use, it is required the die holder for cutting and shaping MX700. Ref. 140-02-02-00045 and cutting die Ref. 140-02-01-00051
For any other different designs, ask the manufacturer

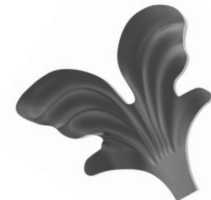

Pieces per set	Thickness	Weight
2	1 - 1,5 -2mm	17,3 Kg

Technical annex

Hydraulic punching machine MX700

List of parts

Hydraulic map

Electric maps · THREE PHASE MACHINE





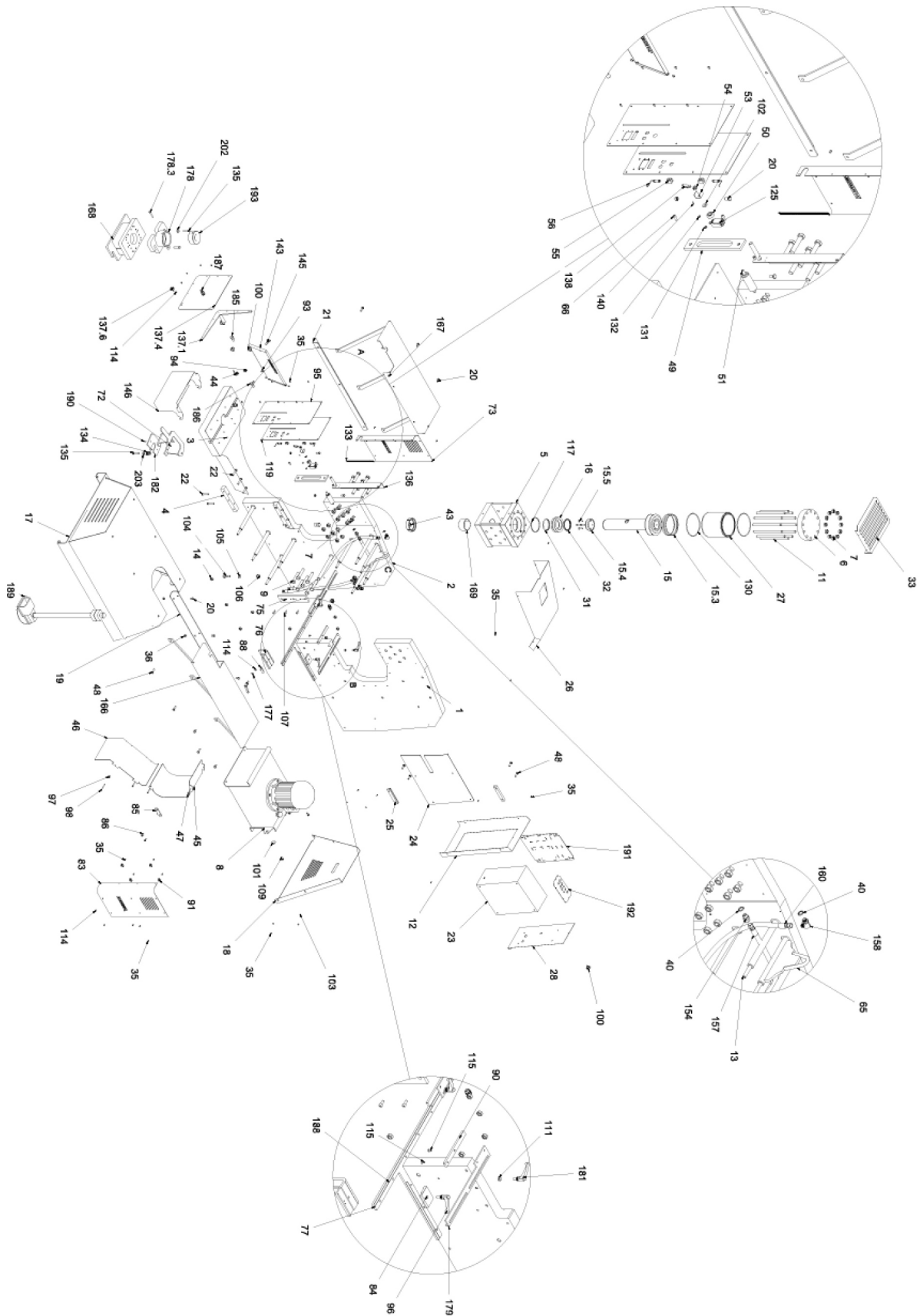











Electric maps · SINGLE PHASE MACHINE

A1. List of parts































IRONWORKER MACHINE MX700

ELEMENTO	IMAGEN	Nº DE PIEZA	CANTIDAD	DESCRIPCION
1		120-02-02-00200	1	PLACA PRINCIPAL DERECHA
2		120-02-02-00201	1	PLACA PRINCIPAL IZQUIERDA
3		120-02-02-00202	1	MESA INFERIOR
4		120-02-02-00026	2	CUADRADO SUJECCION MESA
5		130-02-02-00013	1	BLOQUE PORTA CILINDRO
6		120-02-02-00203	1	TAPA SUPERIOR CILINDRO
7		020-DIN934-M22	26	TUERCA HEXAGONAL DIN 934 M22 8,8 PAVONADO
8		130-02-02-00028	1	GRUPO HIDRAULICO
9		020-DIN931-M22x110	14	TORNILLO HEXAGONAL MEDIA ROSCA DIN 931 M22x110 8.8 PAVONADO
11		120-02-02-00205	12	VARILLA CILINDRO
12		120-02-02-00206	1	TAPA TRASERA INTERMEDIA
13		120-02-02-00211	9	BARRA SEPARADORA
14		020-DIN934-M16	20	TUERCA HEXAGONAL DIN 934 M16 8,8 PAVONADO
15		130-02-02-00031	1	CONJUNTO VASTAGO
15.3		040-DPS-00004	1	JUNTA DPS D200XD180X31.5
15.4		120-02-02-00216	1	ACOPLAMIENTO ROSCADO

















ELEMENTO	IMAGEN	Nº DE PIEZA	CANTIDAD	DESCRIPCION
15.5		020-DIN912-M10X35	4	TORNILLO ALLEN DIN 912 M10 X35 8,8 PAVONADO
16		120-02-02-00217	1	DOLLA CILINDRO
17		130-02-02-00027	1	ESTRUCTURA DE LA BASE
18		120-02-02-00298	1	TAPA TRASERA
19		120-02-02-00221	1	ANGULO DE FIJACION DERECHO
20		020-DIN933-M12x25	12	TORNILLO HEXAGONAL DIN 933 M12x25 8.8 PAVONADO
21		120-02-02-00222	1	ANGULO DE FIJACION IZQUIERDO
22		020-DIN931-M12x65	10	TORNILLO HEXAGONAL DIN 931 M12x65 8,8 PAVONADO
23		050-KIE-0202-001	1	KIT ELECTRICO MX-700
24		120-02-02-00223	1	SOPORTE CUADRO ELECTRICO
25		120-02-02-00224	2	GUIA CUADRO ELECTRICO
26		120-02-02-00225	1	TAPA SUPERIOR
27		120-02-02-00226	1	CAMISA CILINDRO
28		120-02-02-00227	1	TAPA CUADRO ELECTRICO
31		040-RAS-00001	1	RASCADOR 100X110X7/10
32		040-BA-00001	1	COLLARIN 100x110x11.4

















IRONWORKER MACHINE MX700

ELEMENTO	IMAGEN	Nº DE PIEZA	CANTIDAD	DESCRIPCION
33		120-02-02-00228	1	REJILLA SUPERIOR
35		020-ISO7380-M6X12	34	TORNILLO ALLEN CABEZA REDONDA ISO 7380 M6X12 8,8 PAVONADO
36		020-DIN934-M12	12	TUERCA HEXAGONAL DIN 934 M12 8,8 PAVONADO
40		040-JMG-00001	2	JUNTA METAL GOMA 1/2"
43		120-02-02-00312	1	TUERCA ACOPLAMIENTO PUNZON D28 TAP7-N28
44		031-CLT-00001	1	CERRADURA AGA D22
45		120-02-02-00230	1	TAPA ESCOTE
46		120-02-02-00231	1	RAMPA CAIDA
47		020-DIN933-M6X65	6	TORNILLO HEXAGONAL DIN 933 M6x65 8.8 PAVONADO
48		020-DIN933-M12x40	4	TORNILLO HEXAGONAL DIN 933 M12x40 8.8 PAVONADO
49		120-02-02-00022	1	GUIA ANTIGIRO
50		030-CJ-00015	1	RODAMIENTO DE BOLAS 6301 D12XD37X12
51		120-02-02-00232	1	EJE ANTIGIRO
53		120-02-02-00233	1	POSICIONAMIENTO DEL VASTAGO
54		020-DIN985-M12	1	TUERCA AUTOBLOCANTE DIN 985 M12 8,8
55		120-02-02-00234	2	PIEZA PORTA INDUCTIVO















ELEMENTO	IMAGEN	Nº DE PIEZA	CANTIDAD	DESCRIPCION
56		050-IND-M8	2	INDUCTIVO M8
65		130-02-02-00016	1	SUSTENTACION MAQUINA
66		020-DIN912-M10X20	2	TORNILLO ALLEN DIN 912 M10x20 PAVONADO
72		130-02-02-00017	1	EXTRACTOR
73		120-02-02-00236	1	TAPA FRONTAL IZQUIERDA
75		120-02-02-00300	1	GUIA VERTICAL TOPE
76		120-02-02-00301	1	SOPORTE VERTICAL TOPE
77		120-02-02-00302	1	TOPE POSICIONADOR FONDO
83		120-02-02-00237	1	TAPA FRONTAL IZQUIERDA
84		120-02-02-00255	1	FIJACION TOPE
85		120-02-02-00256	1	TOPE FIJACION ESPULSOR
86		020-DIN6921-M8X20	2	TORNILLO EXAGONAL CON BRIDA DIN 6921 M8X20
88		120-02-02-00258	1	INDICADOR POSICION TOPE
90		120-02-02-00260	2	PASAMANO TOPE
91		120-02-02-00307	8	SOPORTE TAPAS LATERALES
93		120-02-02-00264	1	POSICIONADOR SUPERIOR

IRONWORKER MACHINE MX700

ELEMENTO	IMAGEN	Nº DE PIEZA	CANTIDAD	DESCRIPCION
94		120-02-02-00265	1	POSICIONADOR INFERIOR
95		122-02-02-CAL-004	1	CALCA FRONTAL
96		031-MAG-M10-25	2	MANETA GRADUABLE M10x25
97		120-02-02-00262	2	SEPARADOR 16.5 PASANTE
98		020-DIN933-M6X80	2	TORNILLO HEXAGONAL M6X80 DIN 933 PAVONADO
100		031-POM-D40-M6X10	3	POMO M6 X10 DIAMETRO 40
101		120-02-02-00266	2	ARANDELA FIJACION GRUPO HIDRAULICO D45xD10,5x5
102		120-02-02-00267	1	ARANDELA SEPARACION D27xD12,5x1
103		020-DIN125-1B-6	4	ARANDELA DIN 125-B M6
104		020-DIN787-M16-18-63	2	TORNILLO T DIN 787 M16 REGATA 18 ALTURA 63
105		120-02-02-00268	2	ARANDELA MESA PUNZONADO D40xD16,5x6
106		020-DIN6331-M16	2	TUERCA ALTA CON ALA M16 DIN 6331
107		020-DIN912-M10X25	3	TORNILLO ALLEN DIN 912 M10x25 8,8 PAVONADO
109		020-DIN933-M10X25	2	TORNILLO HEXAGONAL DIN 933 M10x25 8,8 PAVONADO
111		120-02-02-00269	2	ARANDELA DE GRUESO TOPE D22xD10,5x5
114		020-ISO7380-M6X10	16	TORNILLO ALLEN CABEZA REDONDA ISO 7380 M6X10 8,8 PAVONADO

ELEMENTO	IMAGEN	Nº DE PIEZA	CANTIDAD	DESCRIPCION
115		020-DIN6912-M8X12	4	TORNILLO ALLEN CABEZA REDUCIDA DIN 6912 M8 X 12 PAVONADO
117		040-JT-00004	1	JUNTA TORICA D130X5 90° Shore
119		120-02-02-00304	1	PLACA FRONTAL
125		050-FC-XCKP	1	FINAL DE CARRERA TELEMECANIQUE XCKP
130		040-JT-00009	2	JUNTA TORICA D208X5,33 90° Shore
131		120-02-02-00279	1	ARANDELA FIJACION PROTECCION D16xD10,2x2
132		030-DIN471-10	1	ANILLO ELASTICO DIN 471 EJE DE D10
133		120-02-02-00278	1	MUELLE PROTECCION
134		120-02-02-00281	1	MUELLE EXTRACTOR
135		020-DIN933-M12X60	3	TORNILLO HEXAGONAL DIN 933 M12 X60 8.8 PAVONADO
136		130-02-02-00021	1	CONJUNTO SOPORTE PROTECCION
137.1		130-02-02-00032	1	CONJUNTO SOLDADURA PROTECCION FRONTAL
137.4		120-02-02-00271	1	PROTECCION FRONTAL
137.6		031-POM-D40-M8X16	1	POMO DIAMETRO 40 M8X16
138		130-02-02-00022	1	CONJUNTO HORQUILLA
139		020-DIN84-M4X28	2	TORNILLO DIN 84 M4x28 CABEZA RANURADA

IRONWORKER MACHINE MX700

ELEMENTO	IMAGEN	N° DE PIEZA	CANTIDAD	DESCRIPCION
140		120-02-02-00282	1	EJE HORQUILLA TAPA
143		130-02-02-00030	1	CONJUNTO PUERTA
145		031-LLT-00001	1	LLAVE CERRADURA AGA 22
146		130-02-02-00024	1	CAJON RECOGEDOR
154		040-RMM-00004	1	RACOR MACHO MACHO 1/2"
157		120-02-02-00283	1	MANGUERA HIDRAULICA
158		040-CGM-00001	1	CODO ORIENTABLE MACHO MACHO 1/2"
160		120-02-02-00284	1	MANGUERA HIDRAULICA
166		130-02-02-00025	1	MESA LATERAL DERECHA
167		130-02-02-00026	1	MESA LATERAL IZQUIERDA
168		130-02-02-00034	1	MESA INTERMEDIA
169		030-DP-00002	1	DOLLA PARTIDA D100xD105x60
177		120-02-02-00290	1	ARANDELA FIJACION VERTICAL TOPE D25xD10,5x5
178		130-02-02-00033	1	MESA PUNZONADO
178.3		020-DIN933-M10X65	1	TORNILLO HEXAGONAL DIN 933 M10x65 8,8 PAVONADO
179		120-02-02-00303	2	TOPE LONGITUDINAL

ELEMENTO	IMAGEN	Nº DE PIEZA	CANTIDAD	DESCRIPCION
181		031-MAG-00001	2	MANETA GRADUABLE M10x20 COLOR NARANJA
182		140-02-02-00020	1	GRUESO EXTRACTOR D70
182A		140-02-02-00021	1	GRUESO EXTRACTOR D50
182B		140-02-02-00022	1	GRUESO EXTRACTOR D20
185		050-PL-00001	1	PILOTO BLANCO D22
186		050-PL-00002	1	PILOTO ROJO D22
187		050-SLL-00001	1	SELECTOR LLAVE D22
188		122-02-02-CAL-005	3	CALCA REGLA LONGITUDINAL
189		050-PED-002	1	PEDAL SIMPLE CON PARO DE EMERGENCIA
190		020-DIN7991-M8X20	2	TORNILLO ALLEN CABEZA CONICA DIN 7991 M8x20 8,8 PAVONADO
193		120-02-02-00313	1	CASQUILLO ACOPLAMIENTO BASE D46 CAB7-N46
202		120-02-01-00017	2	ARANDELA D35xD13x8
203		120-02-02-00309	1	ARANDELA D32xD12,5x4
209		020-DIN913-M12X50	6	ESPARRAGO ALLEN DIN 913 M12X50

A2. Hydraulic map

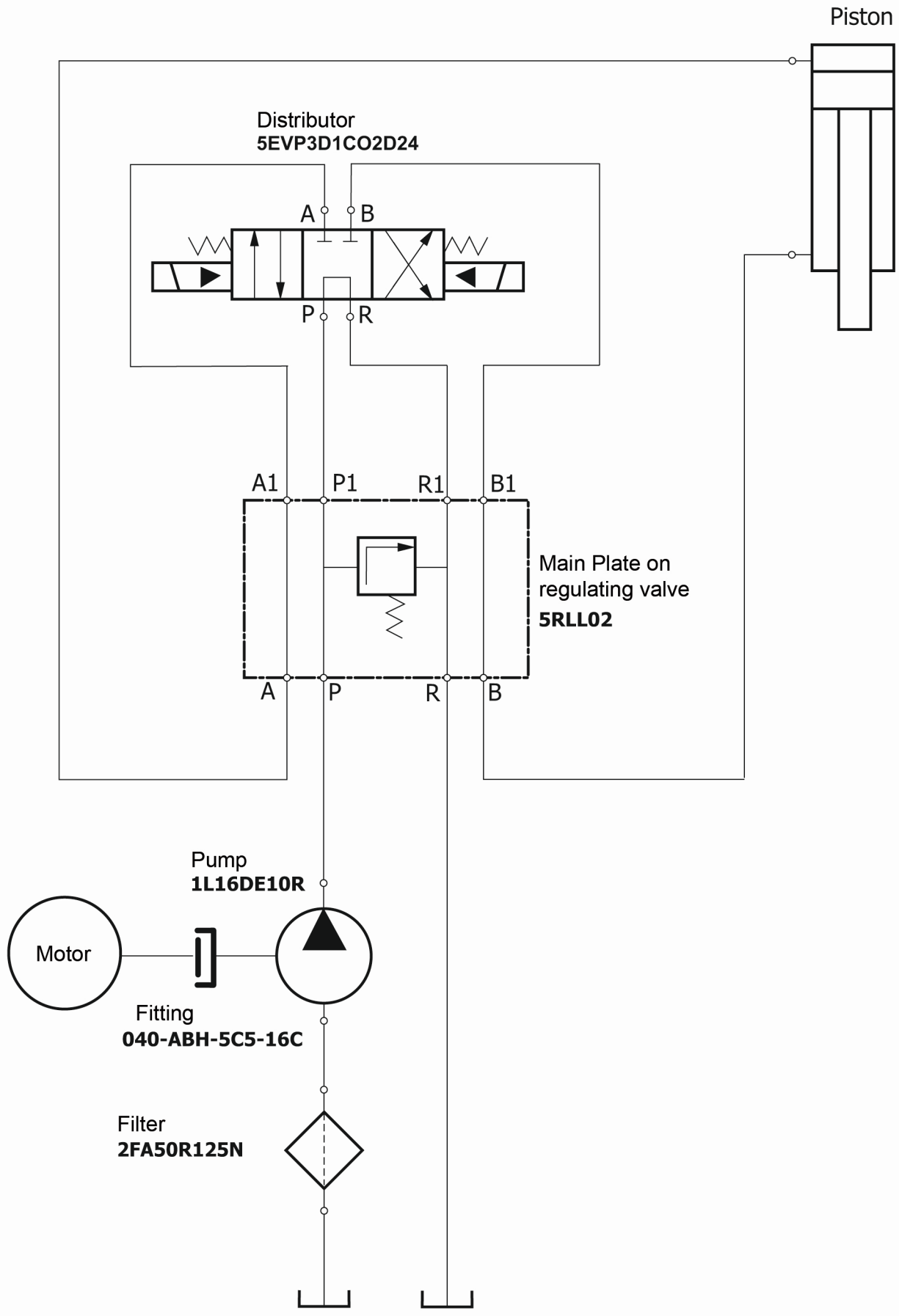

A3. Electric maps · THREE PHASE MACHINE

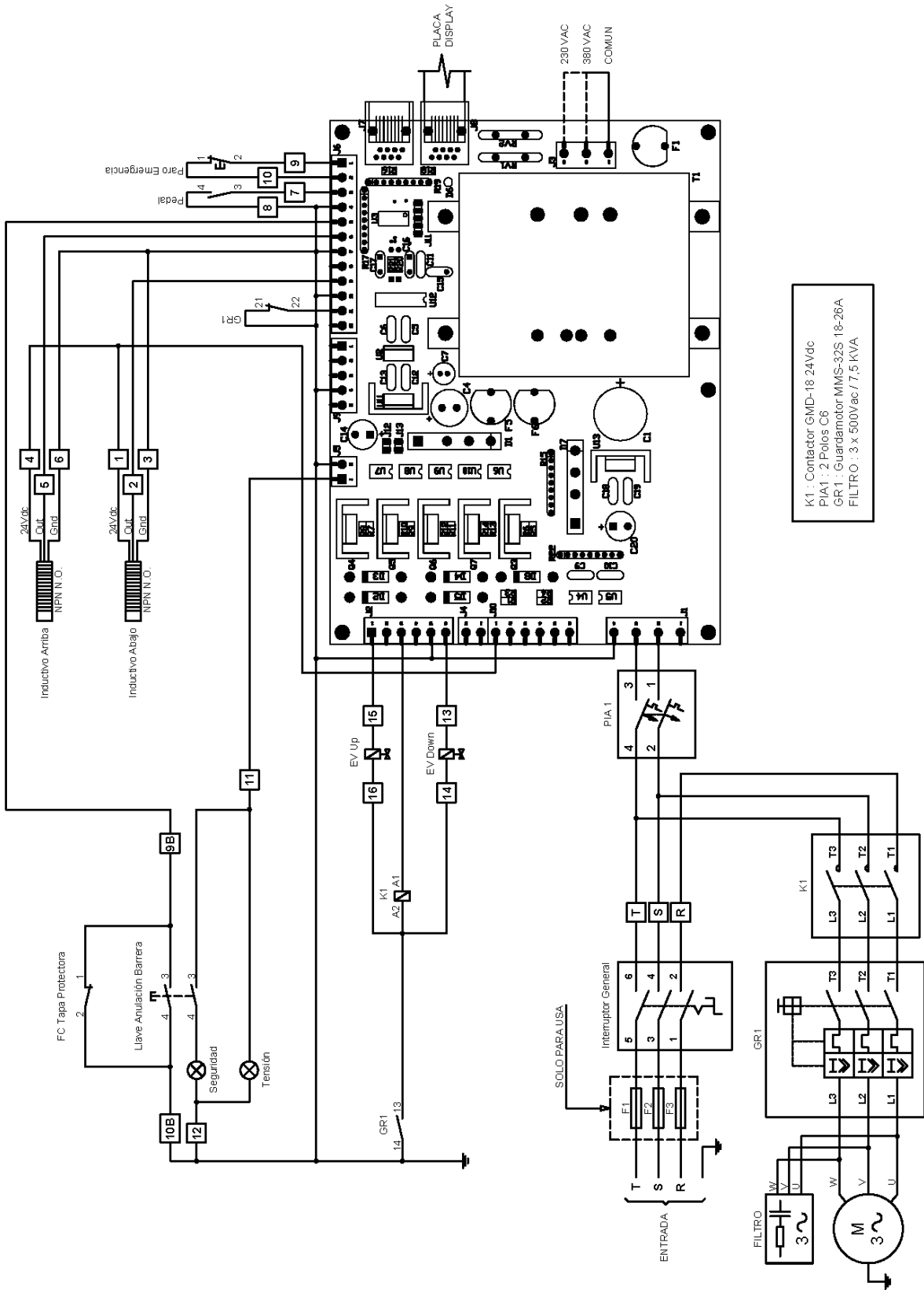

K1 : Contactor GMD-18 24Vdc
 PIA1 : 2 Polos C6
 GR1 : Guardamotor MMS-32S 18-26A
 FILTRO : 3 x 500Vac / 7.5KVA

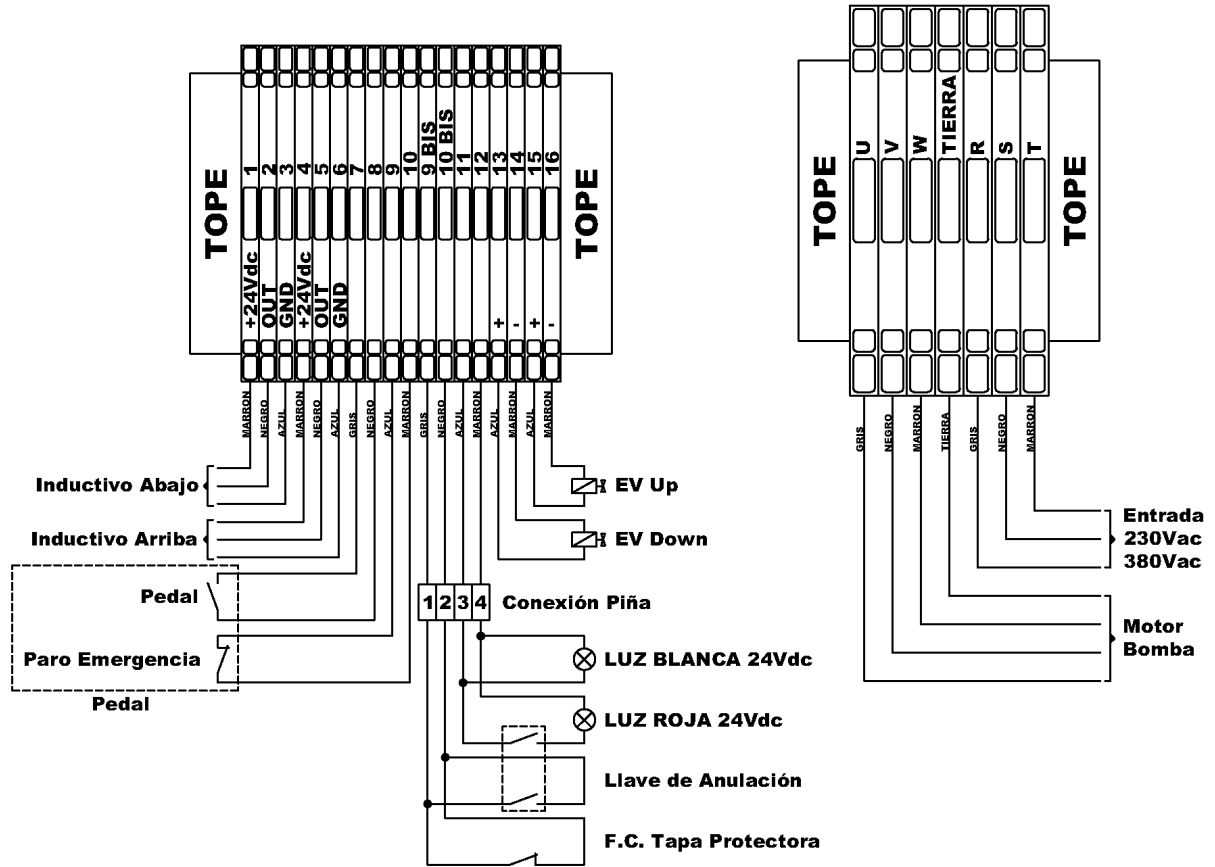

A4. Electric maps · SINGLE PHASE MACHINE

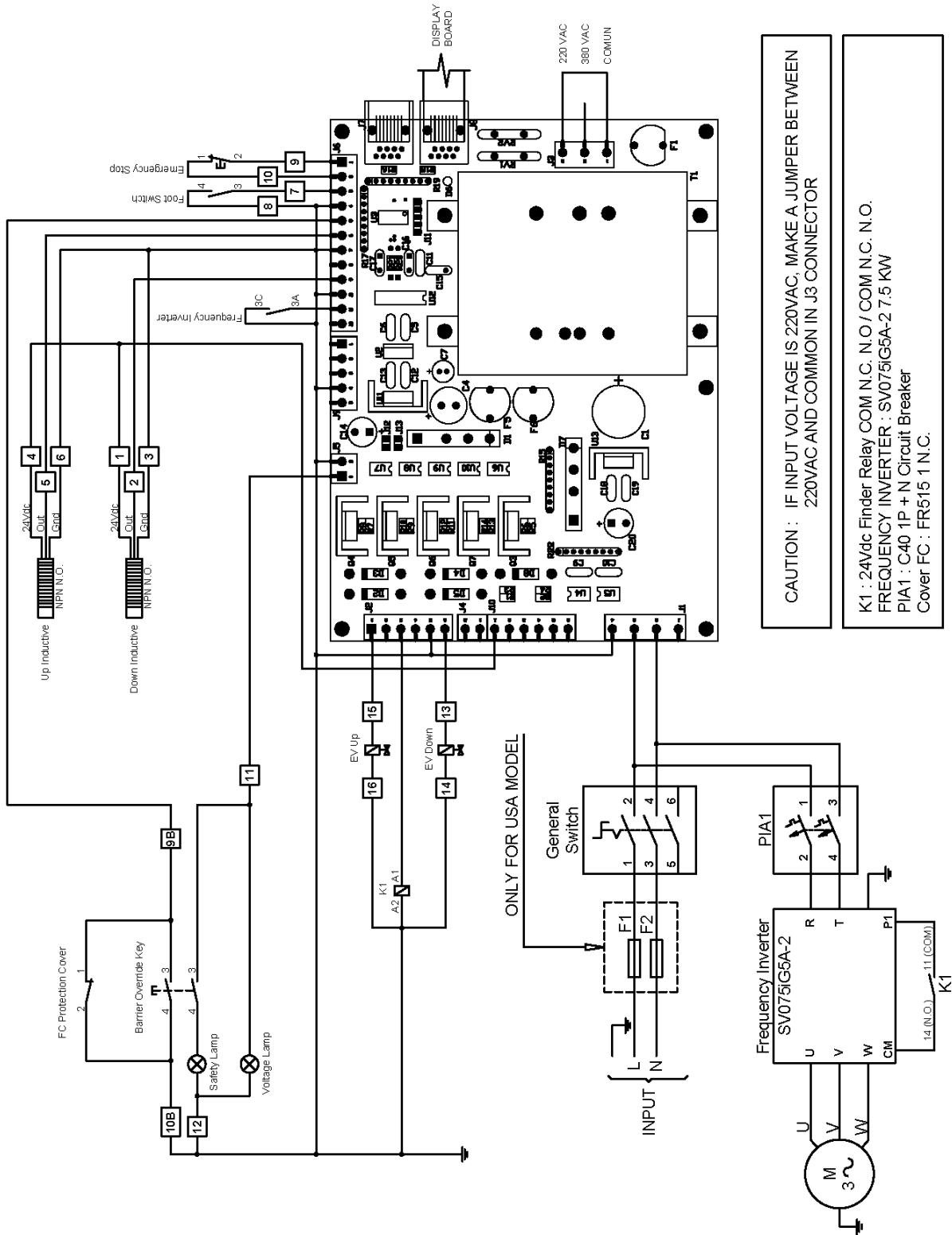

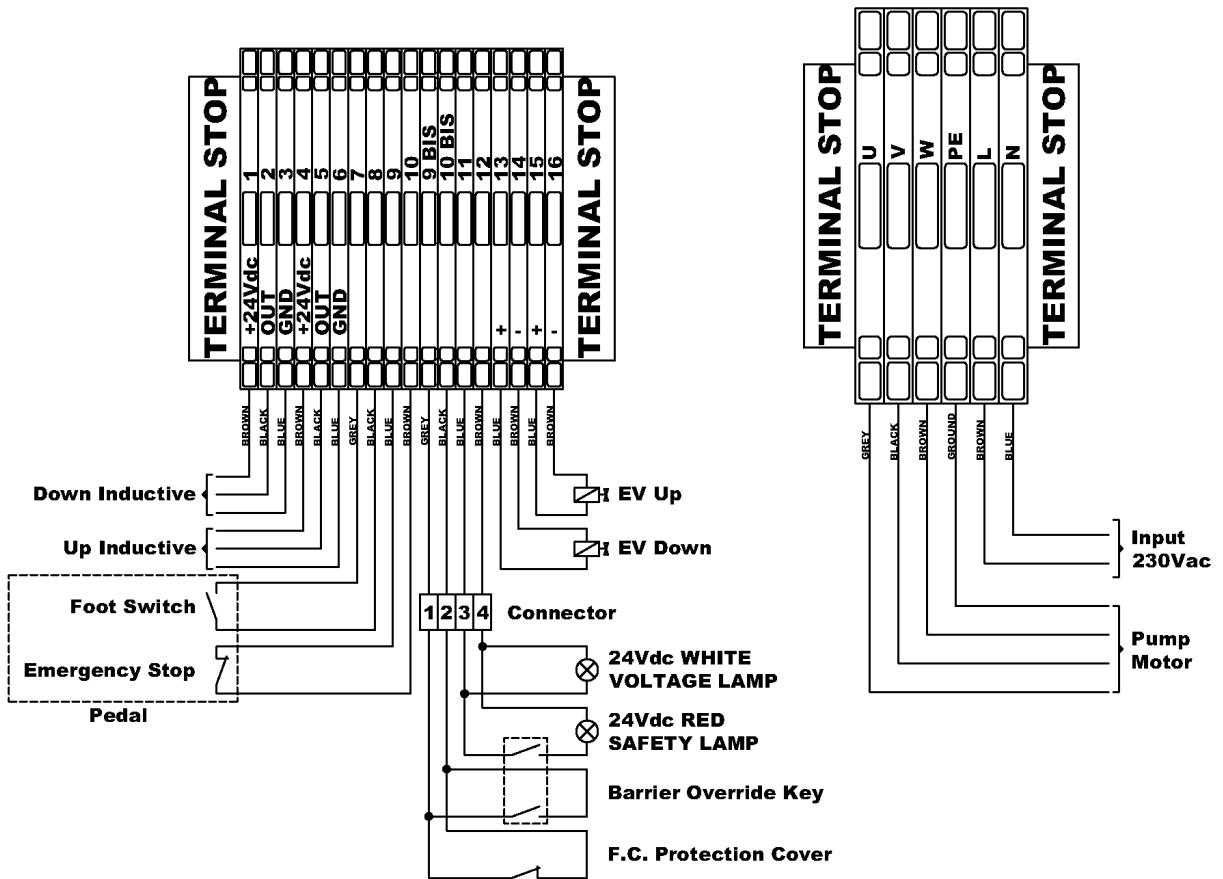

OUR RANGE OF MACHINERY



IRON WORKERS



SECTION BENDING
MACHINES



NON-MANDREL
PIPE BENDER



HORIZONTAL PRESS
BRAKE



TWISTING/SCROLL
BENDING MACHINES



HYDRAULIC PRESS
BRAKES



HYDRAULIC SHEAR
MACHINES

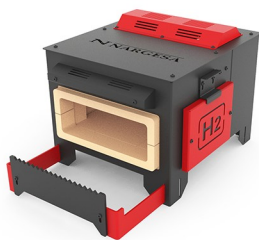

GAS FORGES



IRON EMBOSsing
MACHINES



END WROUGHT IRON
MACHINES



BROACHING
MACHINES



POWER HAMMERS



PRESSES FOR LOCKS