

# **TWISTING MACHINE**

---

## **MT150A**

NS: 2022-2029

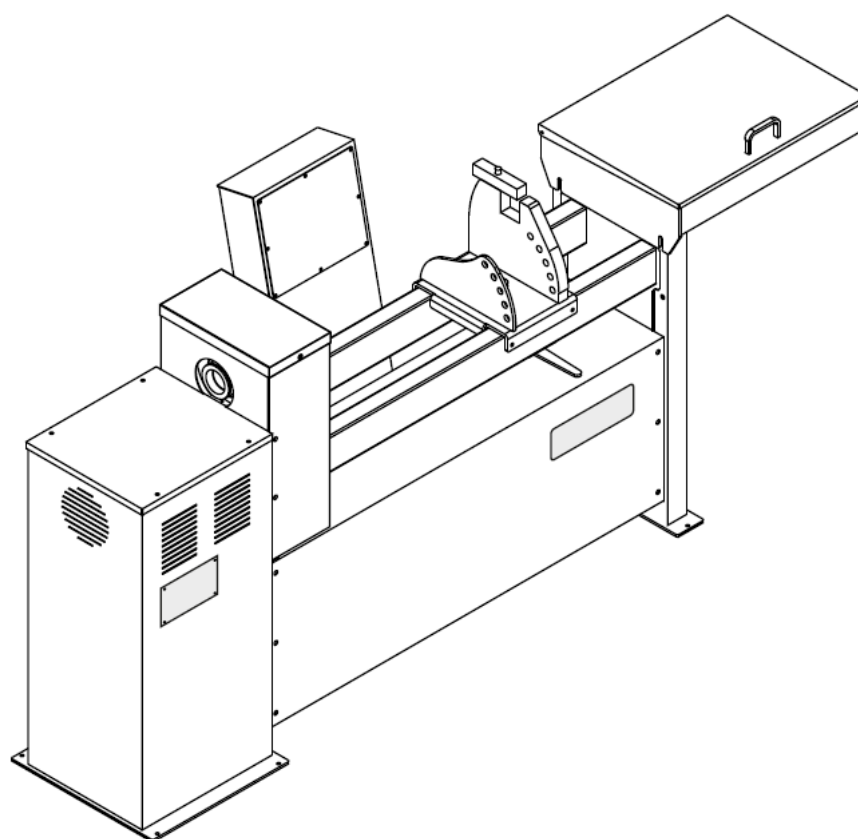

## **INSTRUCTIONS BOOK**

---

**PRADA NARGESA, S.L**

Ctra. de Garrigàs a Sant Miquel s/n · 17476 Palau de Santa Eulàlia (Girona) SPAIN

Tel. +34 972568085 · [nargesa@nargesa.com](mailto:nargesa@nargesa.com) · [www.nargesa.com](http://www.nargesa.com)

Thank you for choosing our machines



[www.nargesa.com](http://www.nargesa.com)

## ÍNDEX

<b>1. MACHINE INFORMATION</b> .....	5
1.1. Machine identification .....	5
1.2. Normal use of the machine .....	5
1.3. Contraindications for the use of it .....	5
1.4. Noise caused by the machine .....	5
1.5. Vibrations .....	5
1.6. Natural working place of the user .....	5
1.7. Description of the machine .....	5
1.8. Description of accessories .....	6
1.9. Descriptions of safety devices .....	6
1.10. Basic characteristics of tooling .....	6
1.11. Information related to the electrical equipment .....	6
<b>2. TRANSPORT AND MAINTENANCE</b> .....	8
2.1. Transportation .....	8
2.2. Dimensions .....	8
2.3. Storage conditions .....	8
<b>3. INSTALMENT AND STARTING UP</b> .....	9
3.1. Instructions to fix it .....	9
3.2. Assembly to reduce noise and vibrations .....	9
3.3. Admissible outer conditions .....	9
3.4. Instructions for connecting to electric supply .....	9
3.5. Safety systems for the user .....	9
<b>4. INSTRUCTIONS FOR THE USAGE</b> .....	10
4.1. Instructions for the adjustment .....	10
4.2. Waste hazards .....	10
4.3. Information about forbidden usage methods .....	10
4.4. Instructions to locate breakdowns and to rearm the machine .....	10
4.5. Instructions for learning how to work with it .....	10
<b>5. MAINTENANCE INSTRUCTIONS</b> .....	10
5.1. Regularity of revisions .....	10
<b>6. EXPLANATION OF ITS PERFORMANCE</b> .....	11
6.1. Introduction .....	11
6.2. Definition of the module for Control and Commands .....	11
6.3. Equipment performance .....	12
6.3.1. Manual mode .....	12
6.3.2. Automatic mode .....	12

6.4. Using the equipment .....	15
6.4.1. Activation of the machine .....	15
6.4.2. Starting up the machine .....	15
6.4.3. Machine in StandBy .....	15
6.4.4. Left turn direction .....	16
6.4.5. Machine in StandBy .....	16
6.4.6. Right turn direction .....	16
6.4.7. Machine in StandBy .....	16
6.4.8. Programming the torsion of a piece .....	17
6.4.8.1. Finding the starting point .....	17
6.4.8.2. Confirming the torsion starting point .....	17
6.4.8.3. Definition of the kind of torsion .....	18
6.4.8.4. Performance of the torsion .....	18
6.4.8.4.1. Square torsion .....	18
6.4.8.4.2. Round torsion .....	18
6.4.8.5. End of the torsion .....	19
6.4.8.6. Taking off .....	19
6.4.9. Machine in StandBy .....	19
6.4.10. Repetition of an existing torsion .....	19
6.4.10.1. Selection of the memory to be repeated .....	19
6.4.10.2. Performance of the selected memory .....	20
6.4.11. Machine in StandBy .....	21
6.4.12. Counting of manufactured pieces .....	21
6.4.12.1. Selection of the memory to be displayed .....	21
6.4.12.2. Deleting the counter of manufactured pieces .....	22
6.4.12.3. Do not delete the counter of manufactured pieces .....	22
6.5. Solution of problems and emergency situations .....	22
6.5.1. Emergency stop .....	22
6.5.2. Interruption of electrical supply .....	23
6.5.2.1. When there was no torsion in process .....	23
6.5.2.2. When there was a torsion in process .....	24
6.5.3. Loss of reference .....	24
6.6. Selection of language and model .....	25
<b>7. STANDARD TOOLING .....</b>	<b>27</b>
<b>8. OPTIONAL TOOLING .....</b>	<b>30</b>
<b>9. MAIN STEPS TO FOLLOW FOR A FAST PROGRAMMING OF THE MACHINE .....</b>	<b>32</b>
9.1. Starting Screen .....	32
9.2. Mass production of pieces .....	33
<b>10. TECHINCAL ANNEX .....</b>	<b>34</b>

## **1. MACHINE INFORMATION**

### **1.1. Machine identification**

Trademark : NARGESA

Type: Twisting machine

Model: MT150A

### **2.2. Normal use of the machine**

The twisting machine is used to shape cold forge materials. It scrolls bars, it makes spirals out of flat bars, etc. All drawings that can be made by using a rotary head and a stand point will be able to be carried out with this machine. It's only shortcoming is the physical space it occupies and the power of the engine.

A set of standard tooling are provided with the machine, by means of which most of the basic shapes will be makeable. However the manufacturer may supply the head adjustment bases, for you to make your own drawings.

**If an accident occurs by negligence of the operative, for not following the safety rules exposed on this manual, PRADA NARGESA S.L will not accept any responsibility.**

### **1.3. Contraindications for the use of it**

Every use out of the ones directed to the cold forge work.

### **1.4. Noise caused by the machine**

In case of this machine noise is almost non existent under a normal working condition.

### **1.5 Vibrations**

Like noise, vibrations could be considered non-existent since it is a fixed machine and the head rotation speed is low.

### **1.6 Natural working place of the user**

The twisting machine could be used by one opeartive at the time who will be located at a side of it.

### **1.7. Description of the machine**

The machine is equipped with an engine of 0,37 Kw / 0,5 HP and a reducer that transmits rotation to the head through a Crown and the body. This is the stand where all the different stand points are located.

The twisting machine has got a box to keep all tooling and the stand table made of steel plate welded and folded.

<b>Engine Power</b>	0,37 KW / 0,5 HP
<b>2 phased tension</b>	230 V Single phased
<b>Rotary speed</b>	Adjustable 0 to 9 r.p.m.
<b>Twisting maximum capacity</b>	20 mm or 3/4"
<b>Bending maximum capacity</b>	16 mm or 5/8"
<b>Max. Scrolling and bending in flat bar</b>	35x10 mm o 1 1/4"x3/8"
<b>Máy. continued scrolling length</b>	960 mm
<b>Dimensions</b>	2270x630x1120 mm
<b>Weight</b>	260 Kg

### 1.8. Description of accessories

The basic accessories the machine has, are the coupling for the head of the different shapes. It is provided with different stand parts, stand point and clamping of materials. In the last part of the manual there is a series of operations which are explained step by step by means of pictures.

### 1.9. Description of safety devices

Gear and moveable parts are covered with the exception of the rotary head.

### 1.10. Basic characteristics of the tooling that can be adjusted to the machine

In case of getting accessories fitted to the machine it is necessary to bear in mind that they need to have the same clamping so that they can not loose or be sent off.

### 1.11. Information related to the electrical equipment

#### **IMPORTANT**

This must be connected to a power supply with ground wire.

The MT150A twisting machine, is equipped with a three-phased motor 230V / 400V 0,37Kw, and an electric set to be able to be connected to a single phased 230V.

The machine can be connected to two different power:

1. A single-phase 230V connection is 230V phase + neutral
2. A two-phase 230V connection is two phases ie 115V

Conversion will not be possible to connect the machine to a three-phase network as long as the installation of the machine is not replaced by a three-phase network installation.

The configuration of the plates located inside the terminal box will always be specified as follows:

Triangle shape  
For tension 230V

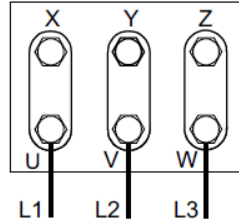

We provide the machine with a frequency inverter instructions book, it will be useful in case of failure to identify it and to report it to technical assistance.

The drive is located inside the cabinet.

Internal parameters of the inverter should not be modified, they must be set at the factory. May only operate the unit under the supervision and advice of NARGESA's Technical Assistance.

Changing these parameters by unauthorized personnel other but NARGESA's, could cause a total suspension of the established warranty.

## 2. TRANSPORT AND STORAGE

### 2.1. Transportation

Transport will be carried out by using a transpalet or lifting truck, as indicated in the following picture. The machine will be transported completely assembled. It is only necessary to turn the tool box.

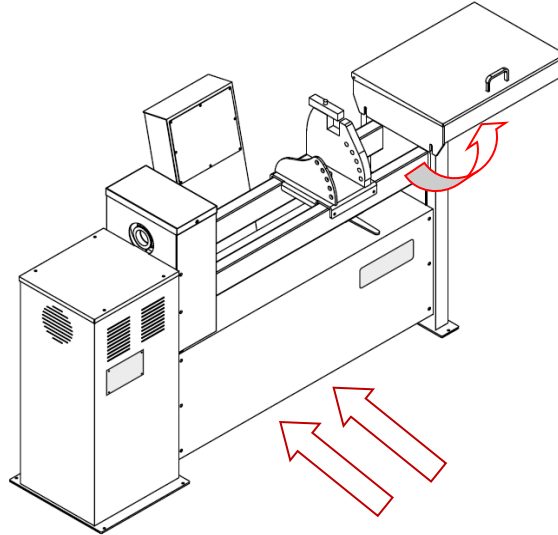

### 2.2. Dimensions

Weight: 260Kg

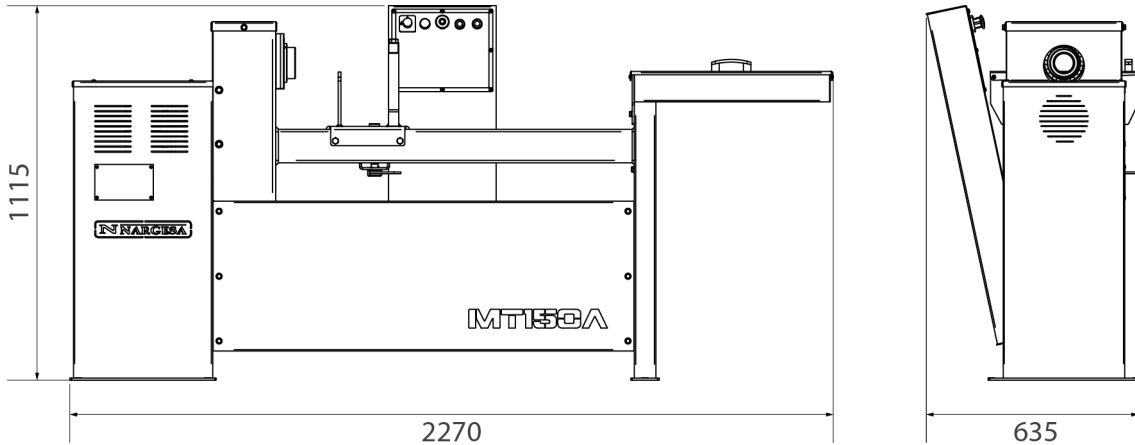

### 2.3. Storage conditions

The machine should be kept in places that follow the requirements described below:

- Humidity between 30% and 95% without water condensation.
- Temperature from  $-25^{\circ}\text{C}$  to  $+55^{\circ}\text{C}$  or  $+75^{\circ}\text{C}$  without exceeding 24 h.
- It is advisable not to pile up machine or heavy stuff on them.
- Do not dismantle the machine to store it.



### **3. INSTALMENT AND STARTING UP**

#### **3.1. Instructions to fix it**

While the machine is left down by the crane, it will be necessary to leave it properly so it hasn't got to be moved once it's on the floor. In case this wasn't possible, then it will be necessary to put it on a moveable base and transport it to its proper place.

The machine will be fixed on the floor for its own weight, so it must be placed in a well levelled and flat surface.

#### **3.2 Assembling to reduce noise and vibrations**

This machine does not produce noise or vibrations due to its low speed.

#### **3.3. Admissible outer conditions**

Environment temperature: Between +5°C and +40°C without exceeding +35°C as average temperature

Humidity: Between 30% and 90% without water condensation.

#### **3.4. Instructions for connection to electric supply**

It must be uniquely connected to the net with the indicated power (220v AC). If the line tension is not the correct one it could cause irreversible damage to the machine.

It is very important to properly connect the machine to the grounding plug.

#### **3.5. Safety systems for the user**

Never for no reason touch the material while the machine is performing.

The machine location should be chosen counting on the space required for the material bar during its distortion.

## **4. INSTRUCTIONS FOR THE USAGE**

### **4.1 Instructions for the adjustment**

This machine hasn't got any adjustable element, with the exception to any kind of repair.

### **4.2 Waste hazards (That cannot be eliminated). Hazard caused by fitted elements**

Always bear in mind to keep hands off the moveable parts of the head to prevent any hazard of arms or finger shearing.

### **4.3 Information about forbidden usage methods**

Do not use any tooling that hasn't been supplied by the manufacturer, in order to avoid the breakdown of any element that could hurt the operative.

### **4.4 Instructions to locate breakdowns and to rearm the machine**

The machine does not tend to breakdowns because of its mechanism. The only possible breakdown would be the change of the operation fuse, in the electric part. This fuse is located inside the command panel or electric box. It is necessary to get the machine unplugged from the electric power supply and then unscrew the cover of the command panel. In the electronic card you will find the operation fuses. In case they have to be replaced, find ones with the same electrical features of the ones changed.

Other possible causes of the fault could be an error message produced by the frequency inverter. Please check up the inverter handling book on section for Faults and Errors.

### **4.5. Instructions for learning how to work with it**

In order to learn how to operate with this machine, place the basic tooling and notice how to position the stand points, see the pictures sequence in the last section. There are also different thick parts and tops in order to adjust the proper height for fastening.

## **5. MAINTENANCE INSTRUCTIONS**

### **5.1 Regularity of revisions**

Revise the pinion and head lubrication every 2000 hours performance.

Gearbox oil: synthetic oil VG320

Capacity: 0,6 liters

## 6. EXPLANATION OF ITS PERFORMANCE

### 6.1. Introduction

The electronic control module has been specifically designed in such way that is rules, either one or the other machine: MT150A or MT150R.

What is stated above could be easily understandable since these two machines have similar characteristics, and so from now on when referring to either one or the other we will use a generic term, such as “twisting machine”.

### 6.2. Definition of the module for Control and Commands.

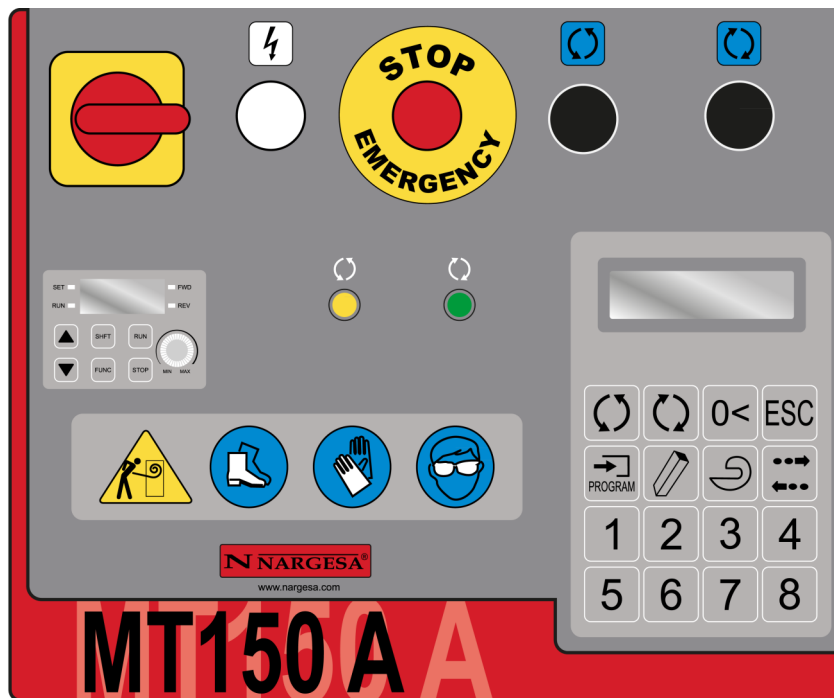

- SET ■ \* ON during parameters configuration
- RUN ■ \* ON during the invertir performance
- FWD \* ON during forwarding
- REV \* ON during rewinding
- ▲ It allows moving on through the codes or increase the value of one parameter
- ▼ It allows to move on through the codes or reduce the value of one parameter
- SHFT It allows to move among groups / numbers of figures inserted on parameters
- FUNC It allows to edit parameters or keep the inserted values
- RUN It commands to start up
- STOP It allows to stop while it's running
- RST: Resets faults
- MIN MAX It allows to change the speed reference frequency

- ↻ Head turn to the right
  - ↻ Head turn to the left
  - 0< Control of manufactured parts o CNT
  - ESC Escape
  - PROGRAM Programming
  - Definition of square torsion
  - Definition of circular torsion
  - ⋮ Pull out
  - 1 2 3 4
  - 5 6 7 8
- Memory for pieces

### 6.3. Equipment performance

The system described offers the chance to work in two different modes: manual mode and automatic mode.

#### 6.3.1. Manual mode

The machine works this mode on default, however it is to be remarked that working on the automatic mode is better, whenever there is a considerable mass production on the same memory.

In manual mode, the user may turn right or left by using the two buttons previously mentioned, so the torsion can be carried out on his will and desire.

Performance is as simple as when pressing one of the buttons , the machine turns until the the user stops pressing it.

Once the user thinks he's got a good point start the torsion of a piece; he inserts it in the mould of the machine and makes the torsion of that piece, to one direction or the other, depending on the selected button. In order to finish the torsion just stop pressing the button that was being pressed.

Now that we have twisted the piece, it is necessary to press the button "Left turning" or "Right turning" in order to pull out the piece since it happens that it is difficult sometimes to get the pieces out once the operation has been finished.

(Always bear in mind all restrictions concerning the kind of torsion and that the pulling out will always be made the opposite direction of the torsion, and it will make the machine go back a few degrees to enable the coming out of the piece.

#### 7.3.2. Automatic mode

The performance principle of this machine is the same of that one at the Manual mode, the difference lies in the fact that this mode is used for the mass production of different pieces, which makes a bit unuseful the use of the machine in the manual mode.

First, once the user has inserted the mould in the machine, he should specify the starting point of the torsion to be made. It is necessary to press the "Programming" key then (it will read in the display a label saying "Define starting point of the torsion"). Then he should specify the point the machine requires to define the torsion by using the the buttons for "Left turning" and "Right turning". So when he finds the proper point to insert the piece in the mould, it is required to stop pressing the turning button to either direction, and to press again the "programming" button (There appears a label on the display similar to that of "Define kind of torsion").

Once we have reached this point, the user should select whether he wants to make a round or square torsion, since he has already put the piece in the machine. In order to do that he has to make it by using the button, no matter if it is the aforementioned one "Round torsion", or the "Square torsion" one (It will appear a label on the display similar to "Define kind of torsion", N°P:00 Reference: 0000". It is important to point out that when making the circle torsion it is only permitted to do it in left direction, for safety reasons, it doesn't happen the same when it comes to square torsions since they can be made to both directions. However once the torsion has been started to one side, it is not possible to go back or change its direction until it has been completely finished.

Now the user should be pressing the "Turn left" button or the "Turn right" button in order to make the torsion of the piece (Keep in mind the shortcomings according to the kind of torsion). Once the user thinks the piece is finished he should press the button according to the 8 memories at his disposal (Memory buttons), so the piece made could be registered then a label will show up on the display: "Registering torsion, Reference:nnnn")

Afterwards, another label will show up reading: "Make unlock". It is required now to use the buttons for "turning left" and "Turning right", it is necessary to specify the point required for the further extraction of the piece.

The user might be pressing the "Turning left" or "Make unlock" button at this point (keep in mind the shortcomings regarding the kinds of torsion, the pulling out will be carried out always the opposite direction of the torsion. When the user sees that the piece has been released he should activate the button according to ("Pulling out" button) in order to register the pulling out operation that has been carried out, however it is to be remarked the fact that in case this pulling out does not allow the user to get the piece out easily, it will be necessary to repeat the whole process again.

In order to make different pieces, just follow the steps that have been previously described and end up the operation registering these torsions in the different memories.

Once you have used all 8 memories it is not necessary to delete any of them to make a new torsion since it is automatically erased once you program a new torsion on an already existing memory .

In case an already registered torsion has to be repeated, just press the memory button that defines the torsion to be done and follow the indications described in the LCD display.

Moreover, the user has the possibility to control the number of pieces made with each memory the machine has. For that, a message will show up on screen reading "Nargesa MT150A, in StandBy" or "Nargesa MT500A, in StandBy" (Depending on the machine that is performing at the moment the user should press the button for "Control of manufactured pieces" (a label will show up on the display reading: "Select Memory"). Once this has been done the user ought to select the memory to be displayed so a message will come out on screen reading "Memory: 01, CNT to delete". In case the user decides to delete this memory, now that the number of manufactured pieces has been checked, just press the control button again (CNT). There is also the "Escape" key that allows to go back to the screen, on default ("Nargesa MT150A, in StandBy"), it can be used whenever there is no torsion in process, if it is so , it is necessary to finish it before going back to StandBy.

This system has also got a safety system that makes the machine locate the starting point when activated after being stopped for a time, this starting point is the one from where all references are taken. Like this, and even if the torsion was made again, the one to be made will be found in the memory that had been selected.

The machine also has an automatic control system that alerts in case the machine has lost reference for any reason. It does not happen a lot however, just in case, the user must follow the steps that are clearly detailed in the LCD display.

Last but not least, it is necessary to point out that the system developed is according to the safety regulations and that in case of any emergency stop situation, the machine won't be able to work again until it reaches its normal way of performance; it is then when the user has to find a new starting point in order to make sure that references are still reliable (always if the user agrees with the new situation and following the indications given in the display, press "ESC" key).

## 6.4. Using the equipment

A graphic way is shown below detailing the steps to follow for reaching a correct performance of the machine, it comes to be like a part of the previous section. The different screens appearing at each moment with the aim of making it easier for the user to understand the functioning of MT150A and MT500A.

### 6.4.1. Activation of the machine



Picture 1. Screen for starting up the machine.

### 6.4.2. InicializStarting up the machine

The user presses the "Esc" button

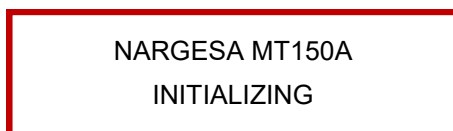

Picture 2. Screen for Initializing.

In this moment the machine makes one turn, then it stops to locate its starting point. Then it will take the references according to thgis point.

### 6.4.3. Machine in StandBy

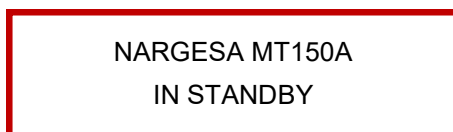

Picture 3. Screen for StandBy on default.

#### 6.4.4. Left turning direction

The user presses the button for “Left Turning”



Picture 4. Screen for left turning.

#### 6.4.5. Machine in StandBy



Picture 5. Screen for StandBy on default

When the user is not pressing any of the buttons, the machines enters into a StandBy mode.

#### 6.4.6. Right turning direction

The user presses the button for “Right turning”.

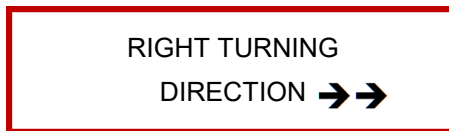

Picture 6. Screen for right turning

#### 6.4.7. Machine in StandBy

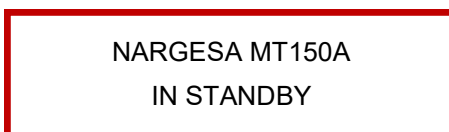

Picture 7. Screen for StandBy on default

When the user is not pressing any of the buttons, the machine enters a StandBy.



#### 6.4.8. Programing the torsion of one piece

The user presses the button for “Programming”.

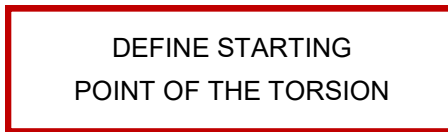

Picture 8. starting screen to define onetorsion

##### 6.4.8.1. Finding the starting point

The user I can either press te button for “Left Turning”

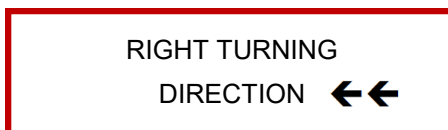

Picture 9. Screen for left turning

Or press the button for “Right turning”

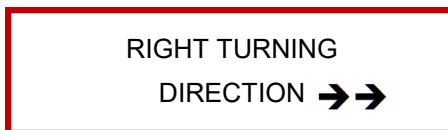

Picture 10. Screen for right turning

Until it reaches the point he thinks is the proper one to start twisteing the piece.

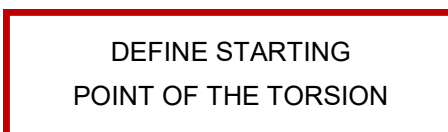

Picture 11. Starting screen for defining one torsion

##### 6.4.8.2. Confirm the starting point of the torsion

The user presses the button for “Programming”



Picture 12. Screen to define the kind of torsion

### 6.4.8.3. Definition of the kind of torsion

The user can either press the button for “Square torsion”, or press the button for “Circle torsion”.

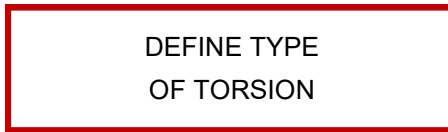

Picture 13. Screen to define the torsion

### 6.4.8.4. Performing the torsion

#### 6.4.8.4.1. Square torsion

The user either press the button for “Turning left”, or the one for “Turning right”

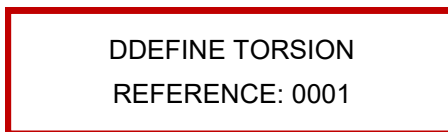

Picture 14. The reference shows the current situation of the torsion

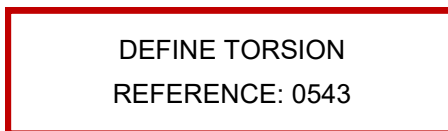

Picture 15. Until the piece has reached the desired torsion

#### 6.4.8.4.2. Circle torsion

The user can only press the button for “Turning left”

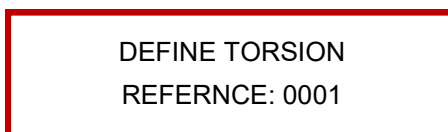

Picture 16. The reference shows the current situation of the torsion

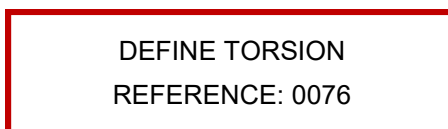

Picture 17. The reference shows the current situation of the torsion

Until the piece has reached the desired torsion

#### 6.4.8.5. Finishing the torsion

The user should press one of the 8 buttons for “Memory”

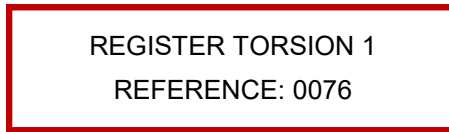

Picture 18. Screen for finishing the torsion

#### 6.4.8.6. Pulling out

The user can only press the button for “Left turning”, or “Right turning”, according to the torsion direction



Picture 19. Screen for pulling out the torsion

The user should press the buttons for “Pulling out”

#### 6.4.9. Machine in StandBy



Picture 20. Screen for StandBy on default

#### 6.4.10. Repetition of an existing torsion

##### 6.4.10.1. Selection of the memory to be repeated

The user presses one of the 8 buttons for “Memory”, where there is a torsion registered

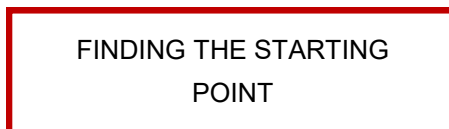

Picture 21. Automatic screen search of the starting point of the selected torsion

The machine turns until it finds the starting point of the selected torsion.



STARTING POINT 1  
FOUND

Picture 22. Screen for the found starting point of the torsion.

#### 6.4.10.2. Performance of the selected memory

The user presses again the same button for "Memory" he pressed before.



STARTS TORSION 1  
N.P: 01 REF: 0000

Picture 23. Starting screen for performing the selected torsion

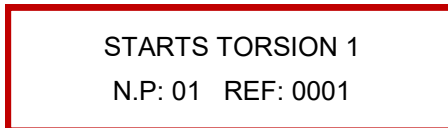

STARTS TORSION 1  
N.P: 01 REF: 0001

Picture 24. The selected torsion starts to be made

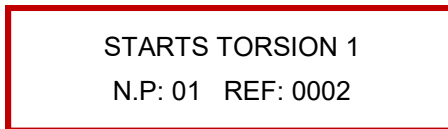

STARTS TORSION 1  
N.P: 01 REF: 0002

Picture 25. The reference indicates de current situation of the torsion

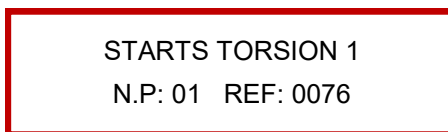

STARTS TORSION 1  
N.P: 01 REF: 0076

Picture 26. The torsion is finished, it reaches the previously specified reference

The machine does the automatic Pull Out of the piece opposite direction to the one the torsion has been carried out.



Picture 27. The torsion is finished and the number of pieces has been increased in one unit.

#### 6.4.11. Machine in StandBy



Picture 28. Screen for StandBy on default.

#### 6.4.12. Control of manufactured pieces

The user presses the “CNT” button



Picture 29. Screen for the selection of the memory to be checked

##### 6.4.12.1. Selection of the memory to be displayed

The user presses one of the 8 buttons for “Memory” according to the memory from which we need to keep control of the manufactured pieces.

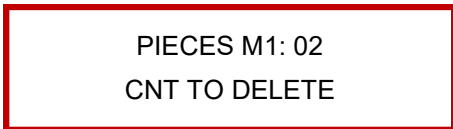

Picture 30. Screen for the control of the manufactured pieces

#### 6.4.12.2. Delete the counting of manufactured pieces

The user press the “CNT” button

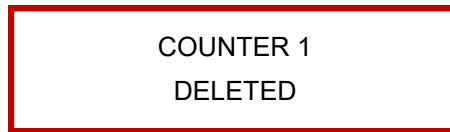

Picture 31. Screen informing about the deleted counter.

This screen will disappear 1 sec later and the machine enters in StandBy mode.



Picture 32. Screen for StandBy on default.

#### 6.4.12.3. Do not delete the counter for manufactured pieces

The user presses the “Escape” button”

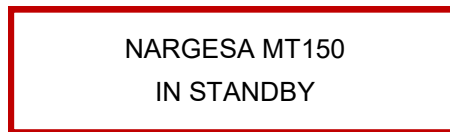

Picture 33. Screen for StandBy on default.

### 6.5. Solutions of problems and emergency situations

#### 6.5.1. Emergency stop



Picture 34. Screen to indicate one emergency stop

Once the emergency situation is solved, the user should pull out the button for “Emergency stop”

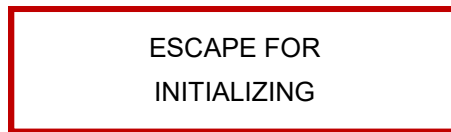

Picture 35. Screen to indicate it is necessary to re-start the machine.

**The user should press the “Escape” button, bearing in mind that there might be one piece in the machine (It is possible to extract the piece before taking out this action by using the buttons for “Left turning” and “Right turning”**

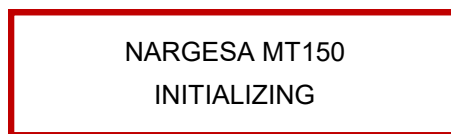

Picture 36. Screen for starting up

The machine will turn until it reaches its starting point, from which on all references are taken. It is then when the machine stops and enters in STandBy.

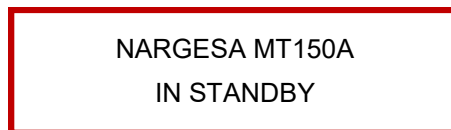

Picture 37. Screen for StandBy on default

## **6.5.2. Interruption of the electrical supply**

### **6.5.2.1. When there was no torsion in process**

Please, see section: “6.4.1. Activate the machine” from chapter “USING THE EQUIPMENT”.

### 6.5.2.2. When there was no torsion in process or any anomalous situation occurs

When the electrical supply is restored the machine shows the following label on the screen.

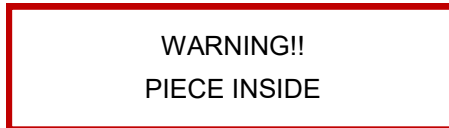

Picture 38. Screen to indicate there is a piece in the machine.

The user should take out the piece from the machine for his own safety. In order to do that and just in case, he can help himself from the movement the machine does if the buttons for "Left turning" and "Right turning" are pressed.

Once this has been done, the user should press the "Escape" button

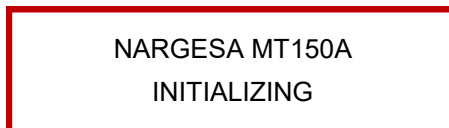

Picture 39. Screen to initialize the machine.

Now the machine turns until it reaches its starting point, from which all references for the torsion. The machine stops at this moment and enters in StandBy.



Picture 40. Screen for StandBy on default.

### 6.5.3. Loss of reference

Although it is not usual that a situation like this occurs, it might happen that the machine loses reference. In case it happens the machine will show the following label in order to avoid the other pieces from being manufactured under wrong references.

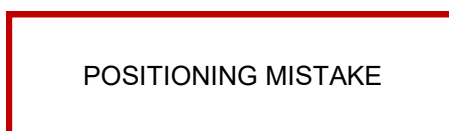

Picture 41. Screen indicating the loss of reference.



After some intermittencies, the machine shows on screen the following message.

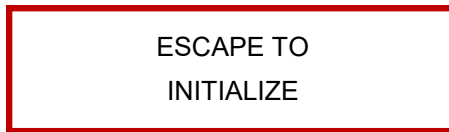

Picture 42. Screen to indicate the machine awaits confirmation to initialize.

The user should press the "Escape" button



Figura 43. Pantalla de inicialización.

Now the machine turns until it finds its starting point. In this moment the machine stops and goes to StandBy.

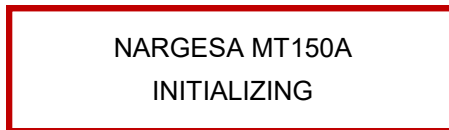
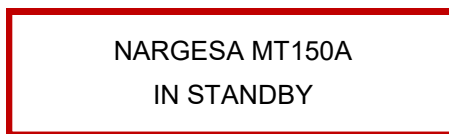

Picture 44. Screen for StandBy on default

### **6.6. Selection of language and model**

This section is the most complicated of the control, because in case a mistake occurs when programming **It could cause irreparable damage to the machine and the control.**

So considering this, the user should obey and follow all steps described below:.

Here the user will find the different screens presented at each moment in a detailed way in order to ease the understanding of the functioning of this machine.

By pressing the key "Left Turning Key" it will be possible to access this menu while the machine is being electrically supplied by the general switch. Once this has been carried out there comes the following information on screen.

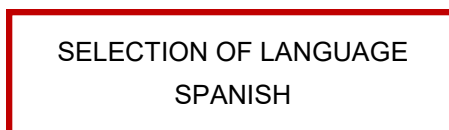

Picture 45. Screen for selecting the language

In order to change the language of the machine just press the following keys:

Key 1 : Español

Key 2 : English

Key 3 : Français

Key 4: Italian

 Polish

Then you will be able to see the selected language on the LCD screen. To confirm it, press the key for “Right Turning”.

Once here, the information on the screen will change into this other one:

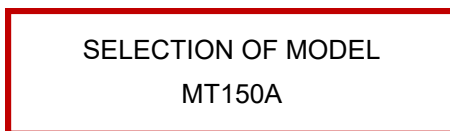

Picture 46. Screen for selecting the model

You can select among three different models by pressing these keys:

Key 5 : MT150A Single phase

Key 6 : MT150A Three phase

Key 7 : MT500A Three phase

Getting one of these options, the change of information will be shown in the screen. Once you agree with the model you want to choose, just press the key for “Right turning” in order to confirm it.

When you do that, there will appear one message on screen for initializing the memories to adjust them to the new model and the machine will restart for a correct performance.

7. STANDARD TOOLING

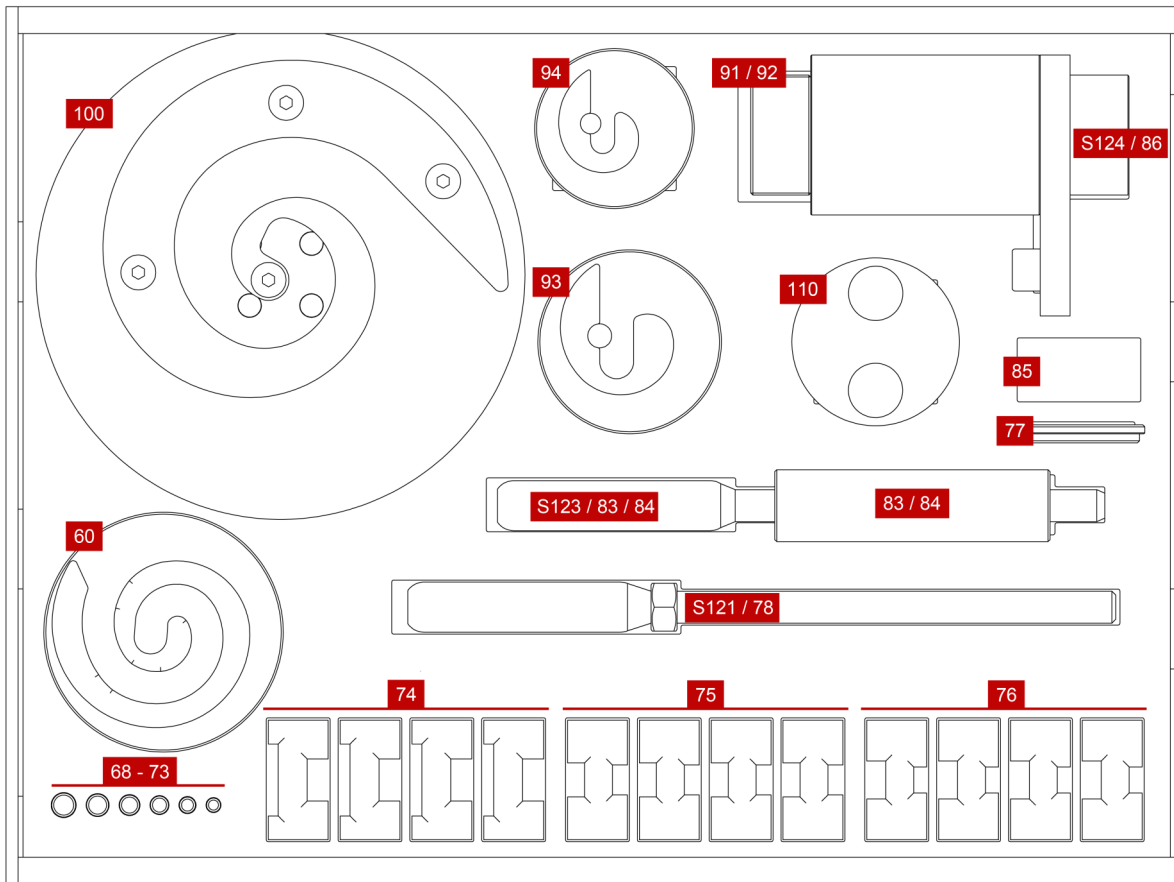

S125	Big Spiral mould	S121	Fastening ring
60	Small spiral mould	77	Fastening washer.
68	Thick 7 mm.	S123	Car stand.
69	Thick 8 mm.	83-84	Car roller.
70	Thick 9 mm.	85	Braided head mould.
71	Thick 10 mm.	S124	Mould to make rings.
72	Thick 11 mm.	91-92	Stand for the mould to make rings.
73	Thick 12 mm.	93	Starting Die for Spiral Diam. 100
74	Square mould 12-18.	94	Starting Die for Spiral Diam. 80
75	Square mould 14-16	110	Mould for hooks and chains
76	Square mould 20- flat bar 35*8.		

Tooling to twist square bar 12mm and 18 mm or 1/4 and 5/8 Inches Whitwort



Tooling made of treated steel F1140 to make twisting in 12x12mm and 18x18mm square bar or 1/4x1/4" and 5/8x5/8" Inches Whitwort, in conventional carbon steel.

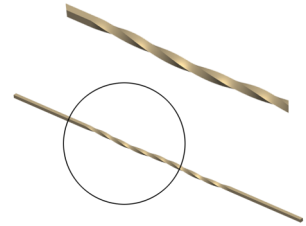

Tooling to twist square bar 14 and 16 mm or 3/8 and 1/2 Inches Whitwort



Tooling made of treated steel F1140 to make twisting on square bar 14x14mm and 16x16mm or 3/8x3/8" and 1/2x1/2" inches Whitwort, in conventional treated carbon.

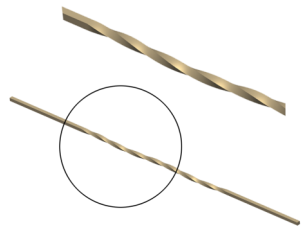

Tooling to twist square bar 20mm and flat bar 35x10 mm or 3/4" and 1 1/4"x3/8" Inches



Tooling made of treated steel F1140 to make twisting on square 20x20mm and Flat bar 35x10mm or 3/4x3/4" and 1 1/4"x3/8" Inches Whitwort, in conventional carbon steel.

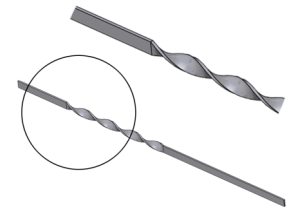

Starting Die for Spiral Diam. 80mm

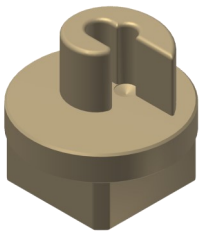

Tooling made of treated steel F1140 to make the start of the spiral in flat bar, square or round, Max. 10mm thickness.

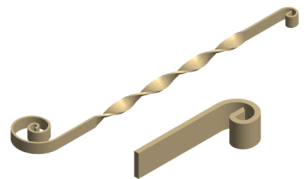

Spiral Tooling Diam. 120mm

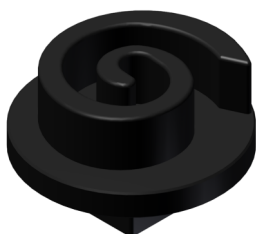

Tooling made of treated steel F1140 to make the second operation of the spiral in flat bar, square or round bar max. 10mm thickness.

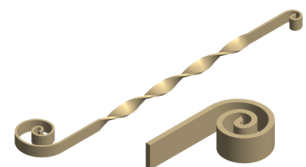

Start Spiral Die Diam. 100mm

---

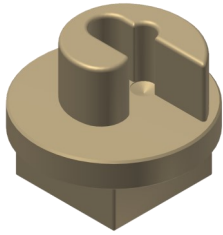

Tooling made of treated steel F1140 to make the start of the spiral in flat bar, square or round, max. 16mm thickness.

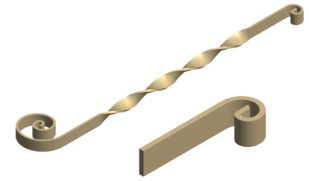

Spiral tooling Diam. 220mm

---



Tooling made of treated steel F1140 to make the second operation of the spiral in flat bar, square or round, max. 16mm thickness.

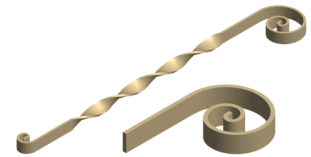

Tooling for Rings of 80mm.

---

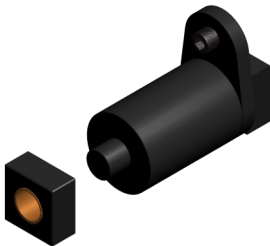

Tooling made of steel F1140 to make rings with inner diameter 80mm either in round or square bar.

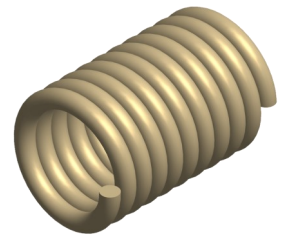

Tooling for braiding round bars

---

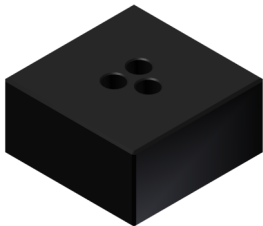

Tooling made of treated steel F1140 to make braids using round rods, maximum three rods of 8mm diam. each.



Tooling for links and hooks

---

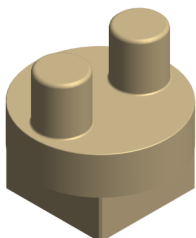

Microfusion treated tooling to make all kinds of folding operations, hooks, links, hooks, chains, etc...

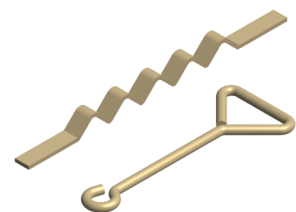

## 8. OPTIONAL TOOLING

### Flat bent rings

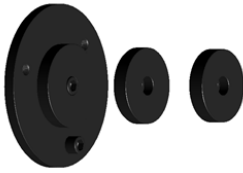

**Reference: 140-01-01-00001**

Steel Die to make round or square bent, the so called English railing.

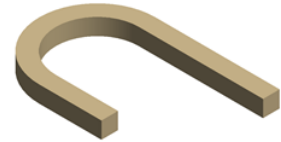

Inner diameter	Max. Capacity	Weight
96, 100, 110 mm	Round or square 16 mm	10 Kg

### Belly top railing die



**Reference: 140-01-01-00002**

Steel Die to make the Belly Top Railing , used in balconies and windows.



Inner diameter	Max. Capacity	Weight
225 mm	Round or square 16 mm	12 Kg

### Flat bar bent die

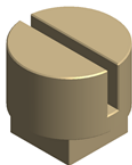

**Reference: 140-01-01-00003**

Treated Steel die for making flat bar folding operations, handrails or clods in all kinds. Folding with minimum external radius.

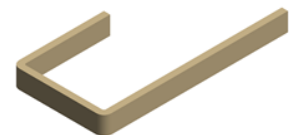

Max. Capacity	Weight
40x10 mm flat bar	3,1 Kg

### Edge scrolls

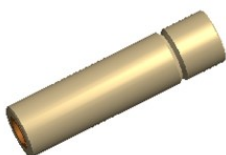

**Reference: 140-01-01-00004**

Treated steel Die to make scrolls or edge spirals in order to give it a different styling touch, it's commonly used in some specific countries.



Max. capacity	Weight
Round or square 16 mm	0,75 Kg

## Baskets tooling

---

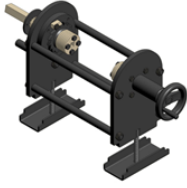

**Reference: 140-01-01-00005**

Tooling to make all kinds of baskets, in different sizes for square or round bars.

Available tooling for millimeter and inch square sizes



---

<b>Max. Capacity.</b>	<b>Weight</b>
4 square or round 10 mm	45 Kg

---

**9. MAIN STEPS TO FOLLOW FOR A FAST PROGRAMMING OF THE MACHINE**

**9.1. Starting screen**



1 - Press it only once when we start the machine or when an emergency stop has been done.

ESCAPE TO  
INITIALIZE



2 - Press it to enter programming.

NARGESA MT150A  
IN STANDBY

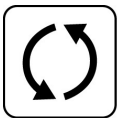

3 - Find the starting point of the torsion to be made by using the black set of buttons.

DEFINE THE TORSION  
STARTING POINT



4 - Press for a second time to confirm the programming of the starting point of the torsion to be made.

DEFINE KIND  
OF TORSION



5 - Choose one out of the 2 programming options, square or circle. With the first one it is possible to program in both turn directions, with the second option it will only be possible to program clockwise.

DEFINE TORSION  
REF: 0000

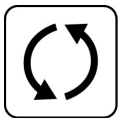

6 - Make the torsion by using the black set of buttons, at once if possible. It is advisable to make the torsion using some material because of the different material hardness. The steps for the torsion operation could be seen on the screen.



7 - Once the torsion has been made, the user should register it in one of the 8 memories of the number keys. Then the message below will show up on screen.

MAKE UNLOCK





8 - Do the pull out by using the black set of buttons, until you can get the material out.



It will only enable you to make the movement of the head the opposite direction to the one the torsion has been made.

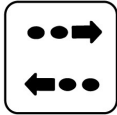

9 - Then press the pull out key and the torsion will be saved along with its pull out operation.

### **9.2. Mass production of pieces**

10 - Once the operation is saved in a memory, if you press the head once it will find the starting point. Place the material in when it has stopped and fix it, then press the same key of the memory and the head will start making the torsion. These two operations are the ones you should be doing so you can make scrolls.

**Technical annex**  
Twisting machine MT150A

---

PARTS

SKETCHES

Power Scheme

Operating Scheme

**10. PARTS**

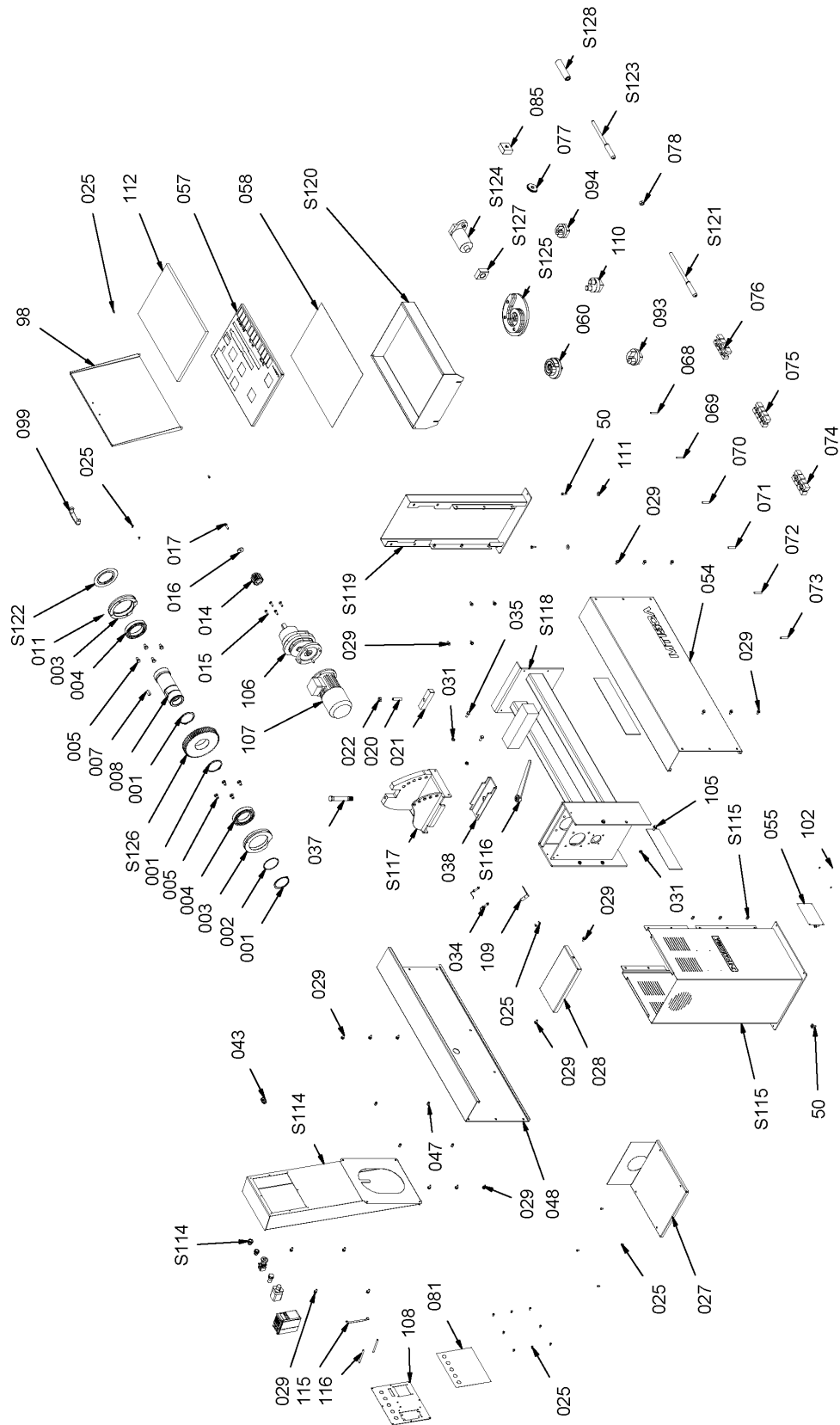

**TWISTING MACHINE MT150A**

<b>Elemento</b>	<b>Nº de pieza</b>	<b>Descripción</b>	<b>Ctdad.</b>
048	120-01-02-00048	CHAPA POSTERIOR MT150	1
054	120-01-02-00054	CHAPA FRONTAL MT150	1
S118	130-01-02-00118	CONJUNTO ESTRUCTURA GUIA MT150A	1
027	120-01-02-00027	TAPA MOTOR REDUCTOR MT150	1
028	120-01-02-00028	TAPA MECANISMO MT150	1
038	120-01-02-00038	ABRAZADERA CARRO MT150	1
S114	130-01-02-00114	CONJUNTO PUPITRE MT150A	1
S120	130-01-02-00120	CONJUNTO PORTA UTILES	1
057	120-01-02-00057	RELLENAR descripcion pieza	1
029	020-D6921-M8X16	Tornillo Hexagonal Embridado Din6921 M8X16	22
014	120-01-02-00014	Piñón Z15 M3.5	1
008	120-01-02-00008	Eje	1
001	030-D471-00007	Circlip Eje DIN 471 D85	3
003	120-01-02-00003	Platina Soporte Cojinete	2
004	030-CJ-00011	COJINETE D85XD130D22 6017-2RS	2
002	120-01-02-00002	Arandela de Ajuste	1
007	120-01-02-00007	Chaveta Corona de 14x9	1
S117	130-01-02-00117	Carro	1
S127	130-01-02-00127	Conjunto Cuadrado Guía	1
107	050-MEFC-00002	Motor Trifasico Con Freno C.C 0.37 Kw 1500 Rpm 50-60Hz 240/400V B5	1
016	120-01-02-00016	Arandela	1
017	020-D933-M8X30	Tornillo Hexagonal DIN 933 M8x30	1
015	020-D933-M8X25	Tornillo Hexagonal DIN933 M8X25	4
005	020-D933-M12X20	TORNILLO HEXAGONAL DIN 933 M12X20	8
047	020-D9317-M8	Tuerca Remachable DIN 9317 M8	4
S116	130-01-02-00116	Llave Apriete Carro	1
S122	130-01-02-00122	Conjunto Nollo	1
037	120-01-02-00037	Tornillo Sujeción Carro	1
021	120-01-02-00021	Brida Sujeción Matriz	1
020	020-D913-M14X60	ESPARRAGO ALLEN DIN 913 M14X60	1
022	020-D934-M14	TUERCA DIN 934 M14	1
025	020-I7380-M6X12	Tornillo Allen Abombado ISO7380 M6X12	10
105	020-D6921-M10X20	TORNILLO HEXAGONAL DIN 6921 M10x20	4
031	020-D934-M10	Tuerca Hexagonal DIN934 M10	6
106	050-RT-00001	Reductor Frc320 S/Brida 1:87 Iec71	1
109	120-01-02-00109	SOPORTE INDUCTIVOS	1
S126	130-01-02-00126	CONJUNTO ENGRANAJE Z60	1
034	050-IND-00001	Detector Inductivo Diell M8 Npn-1030Vd	2
099	031-API-00002	Asa Puente Inserto Metalico M6 L93.4 A35 R2093F-6	1
S125	130-01-02-00125	Conjunto Espiral de 210	1

093	120-01-02-00093	Matriz Inicio Espiral Diam. 100mm { 1ª Operacion }	1
094	120-01-02-00094	MATRIZ INICIO ESPIRAL D80 INI 12	1
060	120-01-02-00060	Matriz Espiral de 16	1
074	120-01-02-00074	Matriz 12 - 18	4
075	120-01-02-00075	Matriz 14-16	4
076	120-01-02-00076	Matriz 20-38	4
S124	130-01-02-00124	Matriz anillas de 80	1
085	120-01-02-00085	Matriz Trenzado	1
077	120-01-02-00077	Arandela Posterior	1
S128	130-01-02-00128	Conjunto Rulina	1
S123	130-01-02-00123	Mango Calibrado	1
S121	130-01-02-00121	Maneta Roscada	1
078	020-D934-M16	Tuerca Hexagonal DIN934 M16	1
068	120-01-02-00068	Varilla Ø 7	1
069	120-01-02-00069	Varilla Ø 8	1
070	120-01-02-00070	Varilla Ø 9	1
071	120-01-02-00071	Varilla Ø 10	1
072	120-01-02-00072	Varilla Ø 11	1
073	120-01-02-00073	Varilla Ø 12	1
058	120-01-02-00058	Goma Fondo Caja Utillajes	1
011	020-D913-M5X10	Esparrago Allen DIN 913 M5 x 10	1
S115	130-01-02-00115	CONJUNTO APOYO IZQUIERDO	1
S119	130-01-02-00119	CONJUNTO FINAL SOPORTE DERECHO	1
055	122-PLC-0000-001	Placa Caracteristicas General	1
102	020-D7337-3X8	Remache De Clavo DIN7337 De Al D3X8	4
043	050-PE-00009	PRENSAESTOPAS PG 13	1
035	020-D933-M10X25	TORNILLO HEXAGONAL DIN 933 M10X25	2
110	120-01-02-00110	Matriz Tetones	1
76	122-EMB-0102-001	Palet de Madera	1
77	120-01-02-00117	Metacrilato Nargesa	1
78	120-01-02-00118	Metacrilato modelo	1
98	120-01-02-00098	TAPA UTILLAJES MT150	1
111	020-D9021-M8	Arandela Ancha DIN9021 Para M8	6
50	020-DIN571-8X30	Tornillo Hex. Para Madera Din571 8X30	6
113	120-01-02-00119	Espuma Cajón-Carro	1
112	120-01-02-00120	Espuma Cajón	1

## 11. SKETCHES

### 11.1. Power Scheme

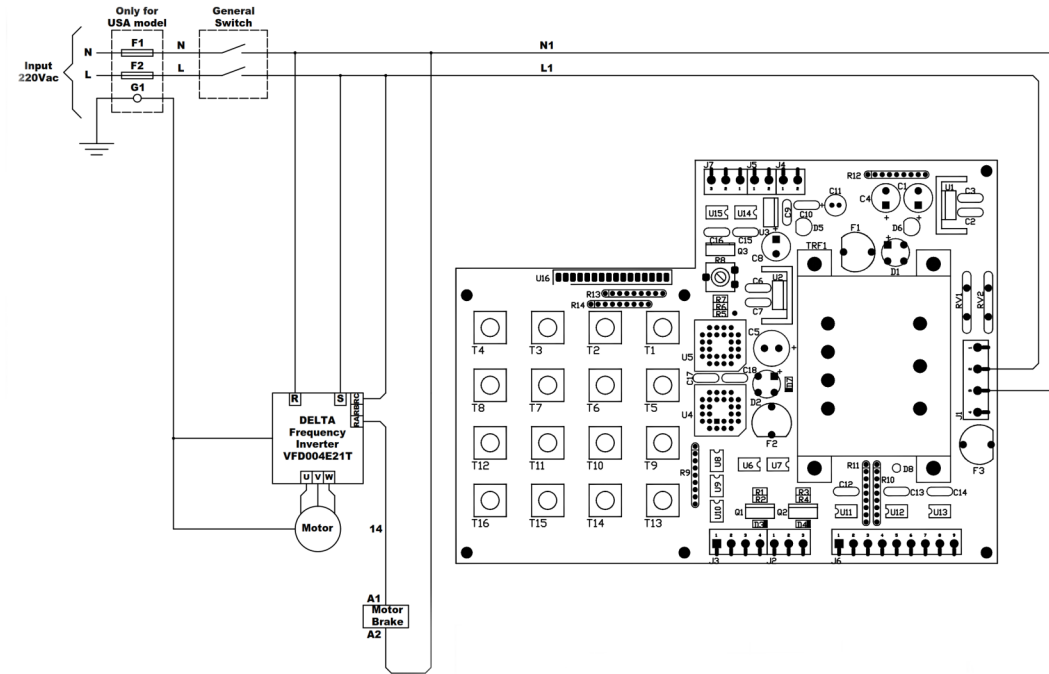

### 11.2. Operating Scheme

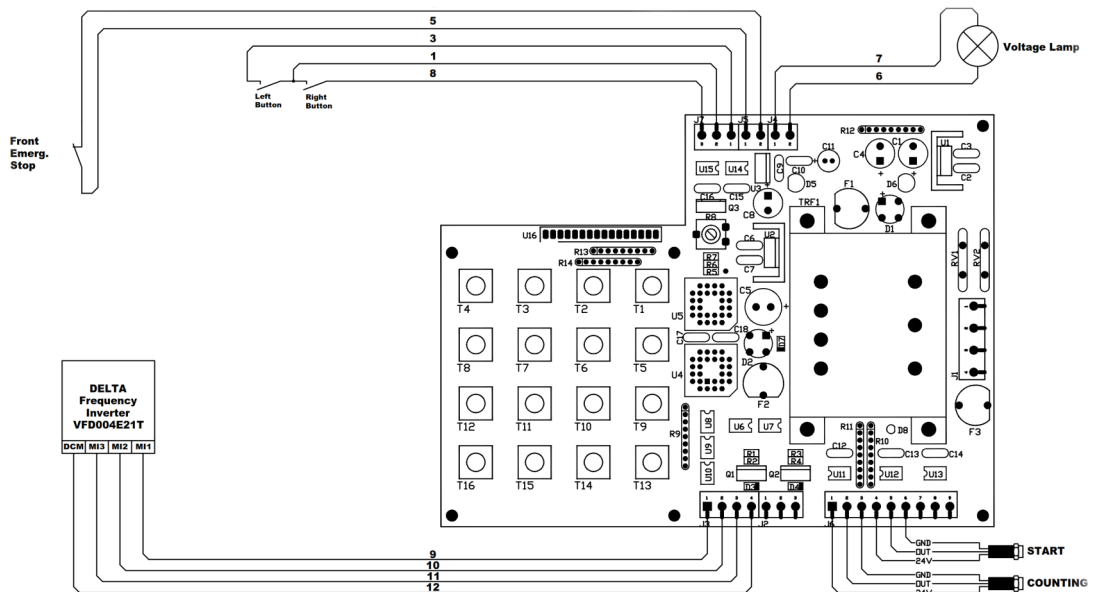

# OUR RANGE OF MACHINERY



IRON WORKERS



SECTION BENDING MACHINES



NON-MANDREL PIPE BENDER



HORIZONTAL PRESS BRAKE



TWISTING/SCROLL BENDING MACHINES



HYDRAULIC PRESS BRAKES



HYDRAULIC SHEAR MACHINES

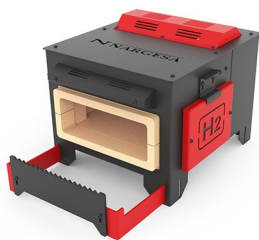

GAS FORGES



IRON EMBOSSING MACHINES



END WROUGHT IRON MACHINES



BROACHING MACHINES



POWER HAMMERS



PRESSES FOR LOCKS