

# **SECTION BENDING MACHINE**

---

## **MC150B**

NS: 2023-330/379

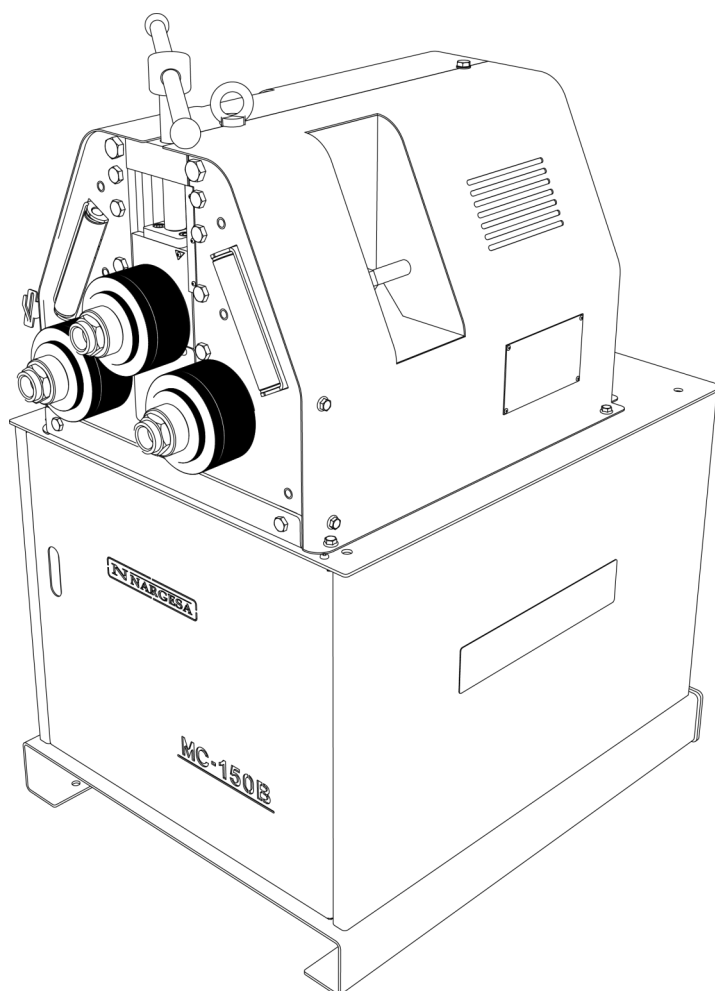

## **INSTRUCTIONS BOOK**

---

**PRADA NARGESA, S.L**

Ctra. de Garrigàs a Sant Miquel s/n · 17476 Palau de Santa Eulàlia (Girona) SPAIN  
Tel. +34 972568085 · nargesa@nargesa.com · www.nargesa.com

Thank you for choosing our machines



[www.nargesa.com](http://www.nargesa.com)

**TABLE OF CONTENTS**

<b>1. MACHINE DETAILS</b> .....	3
1.1. Machine identification details .....	3
1.2. Dimensions .....	3
1.3. Description of the machine .....	3
1.4. Machine part identification .....	4
1.5. General characteristics .....	5
1.6. Description of the guards .....	6
<b>2. TRANSPORT AND STORAGE</b> .....	7
2.1. Transport .....	7
2.2. Storage conditions .....	7
<b>3. MAINTENANCE</b> .....	8
3.1. General maintenance .....	8
<b>4. INSTALATION AND START UP</b> .....	9
4.1. Positioning the machine .....	9
4.2. Dimensions and work area .....	9
4.3. External admissible conditions .....	9
4.4. Instructions for connecting to the power supply .....	10
<b>5. INSTRUCTIONS FOR USE</b> .....	13
5.1. Bending principles .....	13
5.2. Assembling the rollers .....	13
5.3. Positioning the base-plate .....	14
<b>6. WARNINGS</b> .....	15
6.1. Residual hazards .....	15
6.2. Counter-productive methods .....	15
6.3. Other recommendations .....	15
<b>7. ASSEMBLY OF THE ROLLERS</b> .....	16
7.1. Bending capacity .....	17
<b>8. OPTIONAL ACCESSORIES</b> .....	18

**TECHNICAL ANNEX**

## 1. MACHINE DETAILS

### 1.1. Machine identification details

<b>Trademark</b>	Nargesa
<b>Type</b>	Section bending machine
<b>Model</b>	MC150B

### 1.2. Dimensions

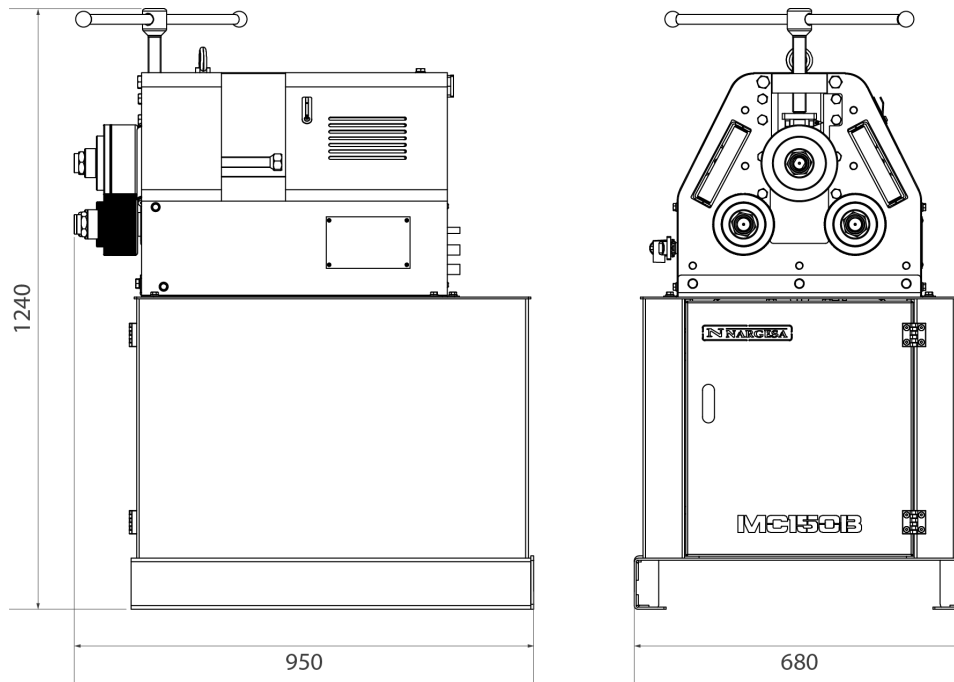

Figure 1. External dimensions of the MC150B bending machine

### 1.3. Description of the machine

The MC150B bending machine is a machine specifically designed for bending profiles, the majority of which are metal, with different thicknesses and configurations, such as solid profiles, pipes, T-profiles, angles...

The bending machine offers a set of standard tools, rollers, to allow the bending of profiles in a range of shapes and sizes.

Apart from the standard rollers, the manufacturer also offers different types of additional rollers to produce other types of bending, according to the configuration of the material to be handled, as well as specific rollers for work with stainless steel or aluminium, manufactured with \* SUSTARIN for jobs in stainless steel or aluminium avoiding the material to be damaged or scratched.

\* *Sustarin*: Polyoxymethylene, high resistance and high rigid crystalline thermoplastic, low friction and excellent dimensional stability

**PRADA NARGESA S.L. is not liable for any damage that might occur due to misuse or failure by users to comply with the safety standards.**

**1.4. Machine part identification**

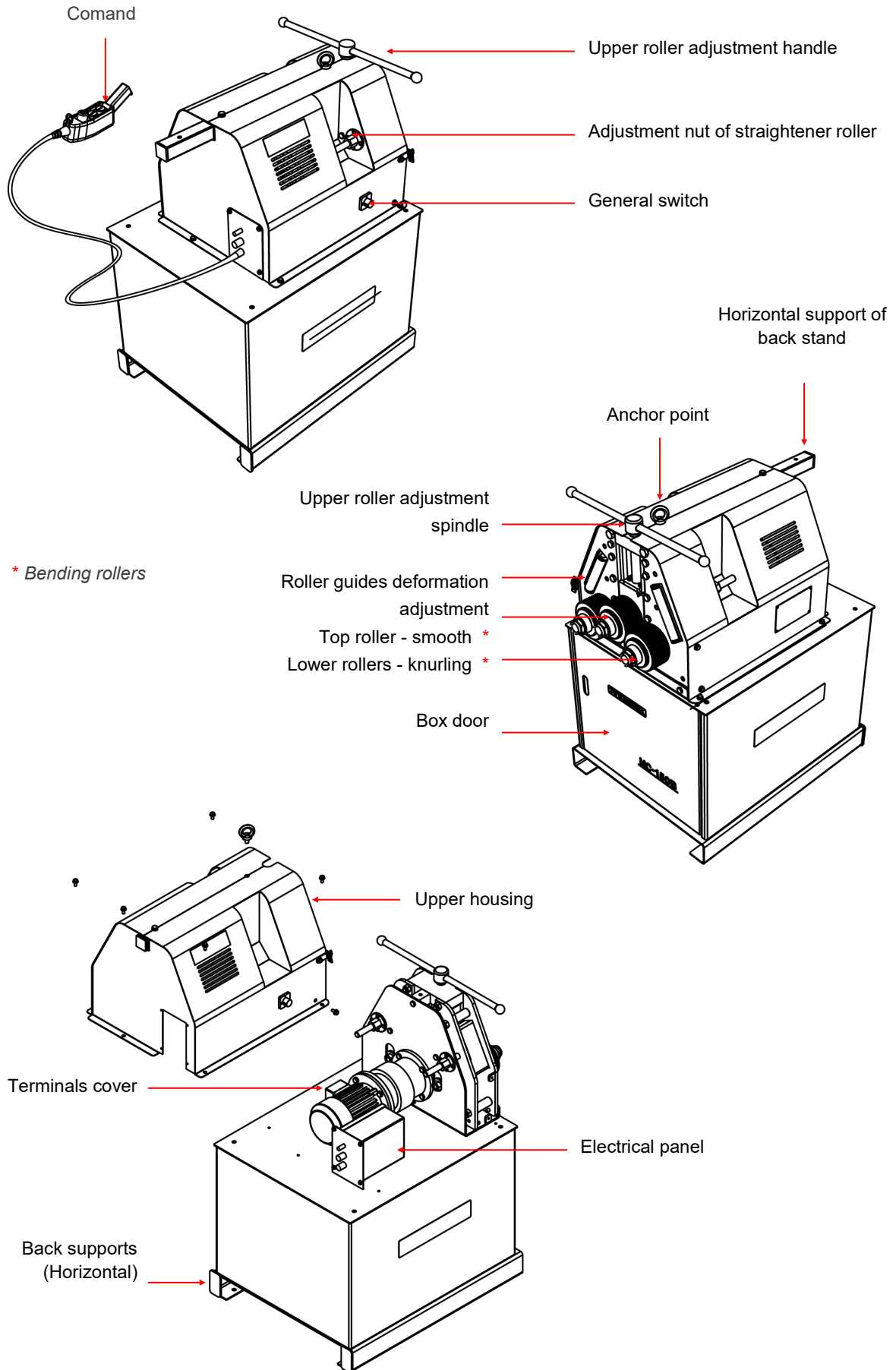



Figure 2. Nameplate

### 1.5. General characteristics

<b>Motor power</b>	0.75 Kw/1 CV a 1400 r.p.m.
<b>Intensity</b>	3.5 / 2 A
<b>Tension</b>	230V Single-Phase 50/60 Hz
<b>Type of pull</b>	Two rollers
<b>Roller speed</b>	6 r.p.m
<b>Rollers diameter</b>	Maximum 157 mm , 127 mm Minimum 40 mm.
<b>Axis diameter</b>	40 mm
<b>Center distance of lower axles</b>	230 mm
<b>Maximum bending capacity in round tube</b>	2' inches or 50 mm
<b>Axis useful length</b>	74 mm
<b>Structure material</b>	Plate
<b>Weight</b>	270 Kg
<b>Dimensions</b>	680x950x1240 mm

### 1.6. Description of the guards

The gear motor and all the gears that allow the operation of the machine are located under the main upper cover that protects the mechanisms.

Although the major mobile elements are protected by the upper cover, it is necessary to take special precautions during bending operations in order to avoid entrapment between the rollers and the piece being bent.

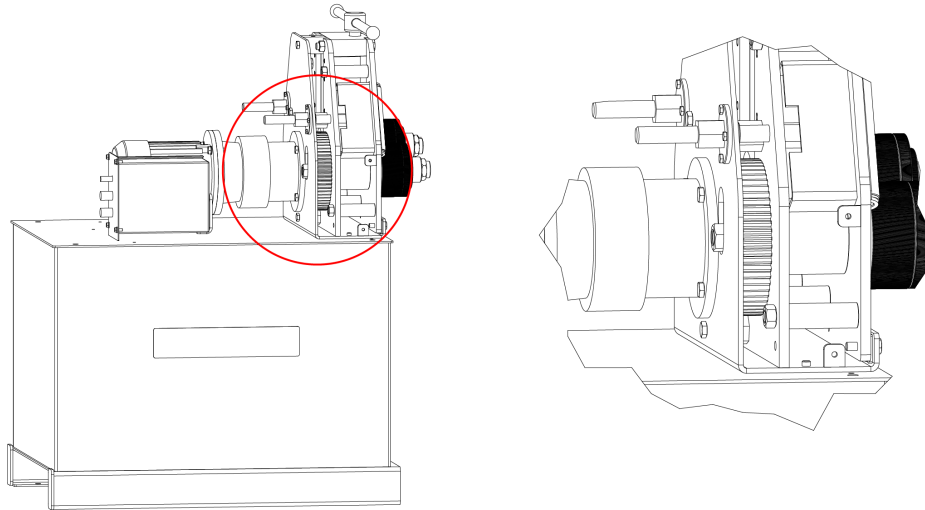

*Figure 3. Mechanism protection guards*

## 2. TRANSPORT AND STORAGE

### 2.1. Transport

There are two ways of carrying out the transportation of the machine:

- From the bottom, through the base of the machine, using a pallet jack or forklift as shown in the illustration. Never raise the machine more than 200 mm from the surface in order to prevent the risk of tipping
- From the top of the machine, from the anchor point designed for this purpose defined in figure 4, using a crane or forklift .

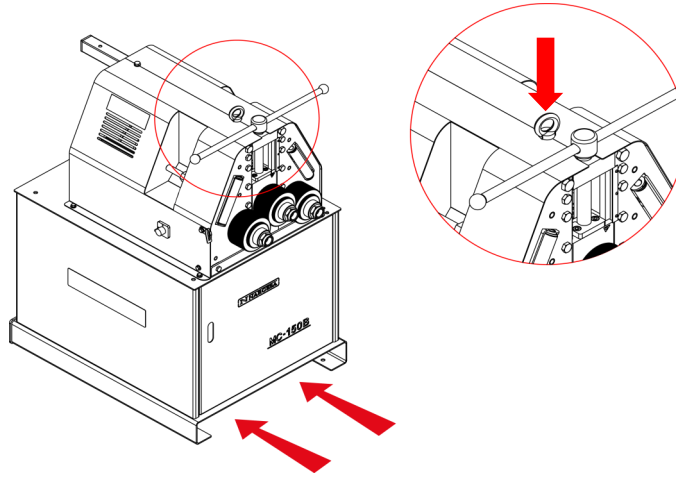

Figure 4. Transportation of the machine

**WARNING:** Before moving the machine it is essential to check that all screws fastening the chassis of the section bending machine to the table, are properly tightened to prevent damage to the machine and users who handle it.

### 2.2. Storage Conditions

The bending machine shouldn't be stored in a place that does not meet the following requirements:

- Humidity between 30% and 95%
- Temperature of -25 °C to 55 °C or 75 °C for periods not exceeding 24hrs (remember that these temperatures are in storage conditions)
- Machines or heavy objects should not be stacked on top



### 3. MAINTENANCE

#### 3.1. General maintenance

- It is recommended to keep the piston rod clean, whenever possible, to ensure proper operation and to extend its useful life.
- It is advisable to keep the friction rule lubricated along which the upper roller support slides. It is also necessary to ensure a minimum lubrication of the inner walls along which the upper roller support slides.

**CAUTION:**

The "Emergency Stop" push button must be pressed and the machine brought to a stop in order to lubricate the machine".

In order to lubricate the moving parts of the machine that require lubrication, it's recommended to follow the next instructions:

- Clean the surface to be lubricated with a cotton cloth or a soft rag that does not release any threads. To remove the accumulated grease and any possible residues that have become stuck to it.
- After cleaning, reapply grease onto the surface with the help of a rag or a spatula.
- Spread the grease evenly without creating excesses or clumps.
- Once the machine is lubricated, using the upper roller adjustment handle that controls the height of the upper roller, raise this until it reaches its highest point.
- When the upper roller comes to its highest point, reverse the direction of the adjustment handle, to lower the roller to its lowest point.
- It is recommended to keep the adjustment spindle of the upper roller lubricated as well as the adjustment nuts to ensure a proper operation, avoid stiffness and extend its useful life.
- You need to at least try minimum greasing on the inner walls through which the support of the upper roller moves.
- Repeat the operation to ensure proper lubrication of all spindles and guides of the upper roller support.
- Lubricate the machine on a regular basis according to its use.

## 4. INSTALLATION AND START UP

### 4.1. Positioning the machine

Locate the machine properly in order to avoid moving it; otherwise, follow the guidelines described in the paragraph transport (no. 2). Must be placed on a flat, level surface to prevent it vibrating and moving during bending operations.

It is optional to fix the machine by the four bolts since it is provided with a lower base or stand with four perforations as it's shown in Figure 5.

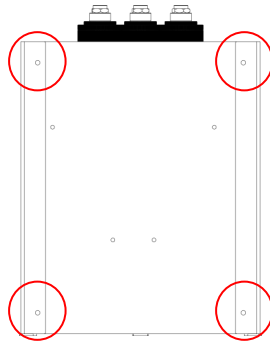

Figure 5. Anchor points of the machine

### 4.2. Dimensions and work area

The dimensions must be considered when the machine is being placed, the working area for the operator and the possible lengths of the parts to be worked.

The bending machine can be used by a single operator, who must be directly in the front of the machine to be able to handle the piece being bent with safety, and never on the side.

Prior to commencing the bending operation, with the machine shut down, the operator must adjust the bending rollers, adapting them to the material and the profile to be bent, as shown in paragraph 7, figure 12.

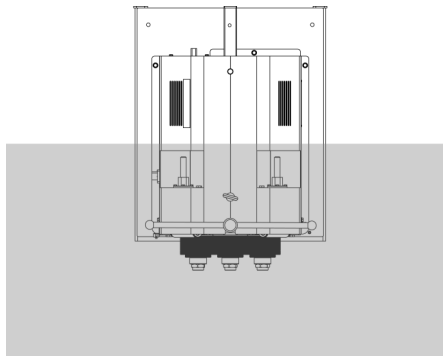

Figure 6. Operator's working area

### 4.3. External permissible conditions

It is advisable to work under the following atmospheric conditions:

- Room temperature between +5 °C and +40 °C without exceeding an average temperature of +35 °C within 24 hrs.
- Humidity between 30% and 90% without water condensation .

#### 4.4 Instructions for connecting to the power supply

**IMPORTANT: This machine must be connected to an electrical outlet with earthing contact.**

The pipes and section bending machine MC150B, is equipped with a three-phased motor 230V/400V 0.75kW and it's ready to be connected to a three-phased 400V drive with earthing contact.

In opposition, if you connect the machine to a three-phased 230V drive it's necessary to make the following changes in the control panel:

- Change of the main motor coil connections
- Change of the transformer connections
- Adjustment of the intensity range of the engine guard contactor

Change connection of motor bobbins.

To connect the machine to a three-phased 400V drive motor bobbins must be star like connected (default). On the other hand, to connect the machine to a three-phased 230V drive motor bobbins must be triangularly shaped connected.

The change in the coil connection is performed through the motor terminal box located at the rear of the machine, changing the configuration of the plates according to the available power outlet. The two possible configurations are shown below:

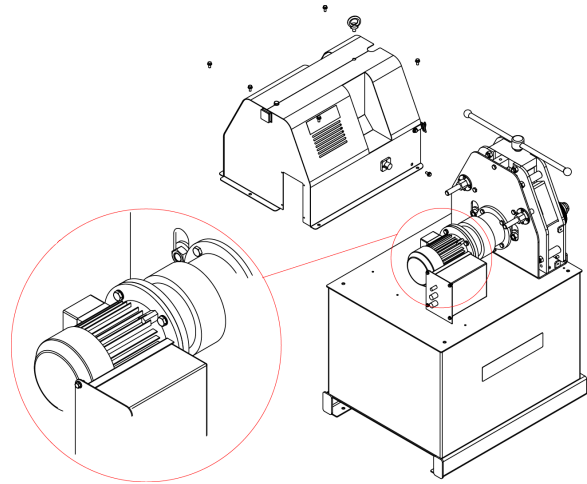
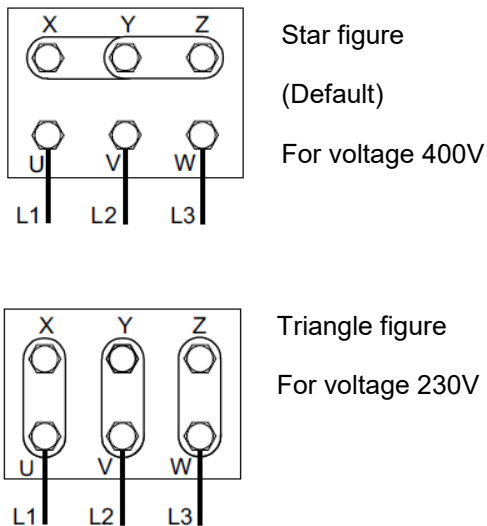

Figure 7. Change of engine connections

**Before making any changes to the wiring of the motor bobbins or electrical panel, it is essential to check that the machine is not connected to any power source.**

### Changing connection of the converter primary

Depending on the voltage available at the outlet it will be also required to change the connection of the converter primary which is fixed to the electrical panel inside the the machine box as shown in section A2. Electrical Box on the Technical Annex.

If the machine is connected to a 400V three-phased power supply it is necessary that the power connection of the transformer primary is made between terminals labeled "0V" and "415V". In case of having a 230V outlet drive, then disconnect the power cord from the terminal "415V" of the transformer primary using a screwdriver and connect it to terminal "230", right afterwards tighten the clamping screw with the screwdriver.

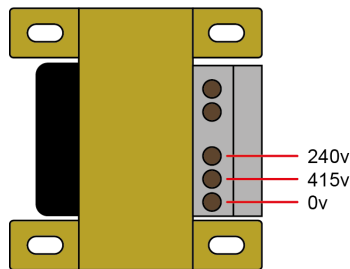

Figure 8. Change transformer primary connection

### Adjusting Intensity of engine-keeper

Depending on the line voltage the current consumption varies the of the machine. It is therefore necessary to adjust the labor intensity of thermal motor protection. The rangers engine is fixed to the electrical panel inside the cabinet of the machine, as shown in section A2. Electrical Box, on the Technical Annex.

To adjust the intensity of the engine-keeper simply turn the knob located on the front, using a Phillip screwdriver, positioning the indicator arrow at the correct intensity.

In case of having a three-phased outlet 400V drive the engine-keeper must be set at an intensity of "2.6A". On the contrary, in case of having a three-phased outlet 230V drive the engine-keeper at an intensity of "5A".

If the engine-keeper installed can not be adjusted to the required intensity, it must be replaced by one with a higher amperage.

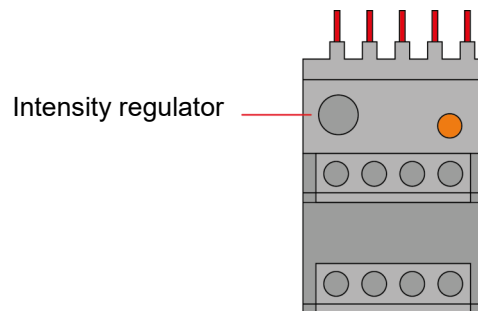

Figure 9. Adjust the intensity of the engine-keeper.

The MC150B section bending machine, is equipped with an electric set to be able to be connected to a single phased 230V.

The machine can be connected to two different power:

1. A single-phase 230V connection is 230V phase + neutral
2. A two-phase 230V connection is two phases ie 115V

Conversion will not be possible to connect the machine to a three-phase network as long as the installation of the machine is not replaced by a three-phase network installation.

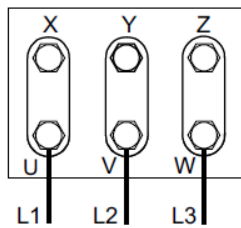

Triangle figure  
For voltage 230V

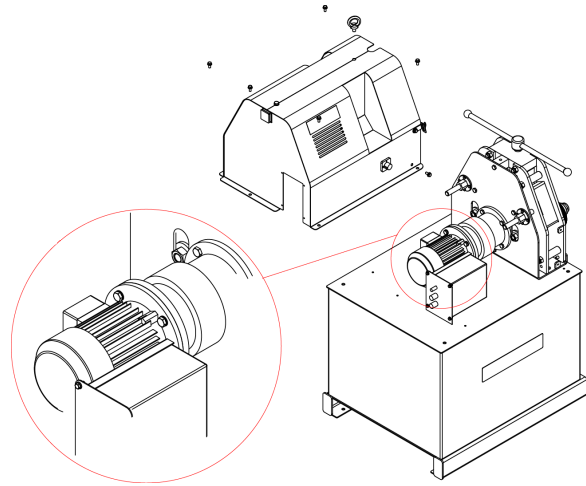

## 5. INSTRUCTIONS FOR USE

### 5.1. Bending principles

- The activation of the engine of the section bending machine is made through a wired control that has got three buttons: one for the emergency stop, another one for the right turn and a third one for the left turn.
- To set the radius of curvature, adjust the height of the upper roller through the adjustment handler located on the top side of the machine.
- For the emergency stop just press the emergency button located on the top of the joystick.
- You can place the material in the machine on both sides. Use the upper handle to adjust the height of the upper roller and thereby adjust the material input. Use the millimetre scale to recognize the position.
- The distance between the deformation adjustment roller guide and the work surface must be modified in order to adjust the alignment of the material. This task will be performed by tightening the adjusting screws located at the rear of the machine. These roller guides guide the material to minimise lateral deformation. (The support roller guides must gently press against the profile to be bent)
- It is recommended to cut the tip into a wedge shape in order to obtain optimum bending in the profile to be worked, to facilitate its entry.
- In the event of not obtaining the proper results, the position of the guide rollers for deformation must be adjust.
- The roller mounting nuts must be tightened by manual force only .

### 5.2. Assembly of the rollers

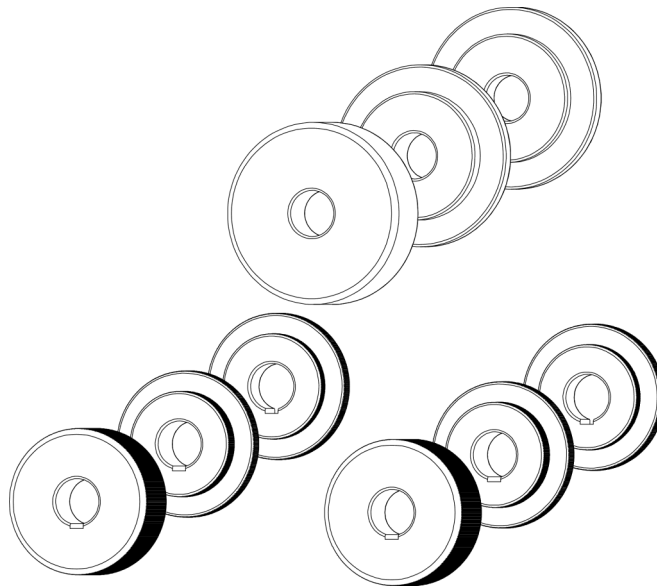

Figure 10. Position of the rollers in relation to the machine axes

### 5.3. Positioning the base-plate

In order to place the machine on its horizontal working mode it is required the help of a crane and the intervention of two users.

Before you begin, make sure that the adjusting bolt top roller is in its lowest position, in order to avoid interference of it when overturning the machine.

Take the rear support off and fix with the screw and washer located on the top of the MC150B.

Afterward, ensure the machine with a locking device. This device will link the crane cable with safety ring available on top of the section bending machine.

Lastly, knock down the machine cautiously by using the crane with caution until the rear foot rests on the floor.

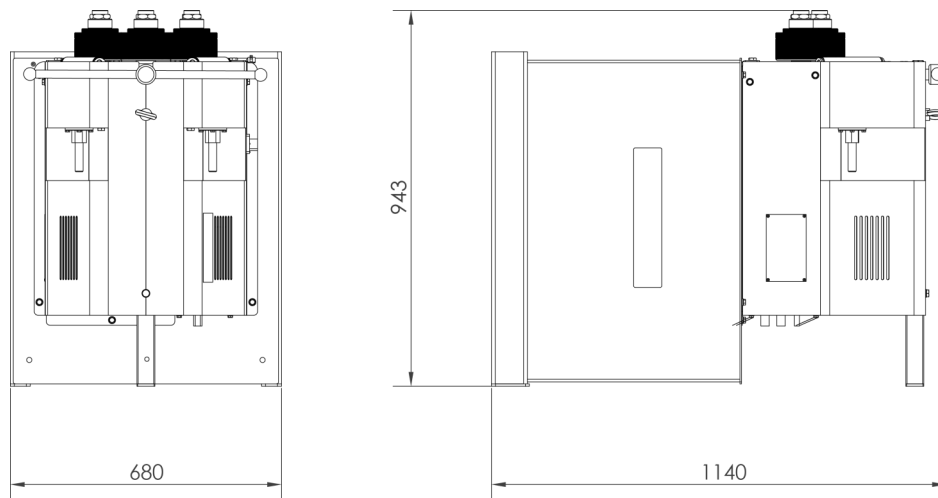

*Figure 11. Machine dimensions with the base-plate in a horizontal position*

#### **ATENCIÓN**

Do not pull the crane until the machine is resting on the floor to avoid injuring users or damaging to the machine.

## **6. WARNINGS**

The MC150B bending machine is designed and assembled to allow the operator to handle the machine and bend the necessary parts in a completely safe manner. Any change to the machine's structure or characteristics could modify the safety offered by the machine, breaching the EC certificate of conformity and could endanger the operator.

### **6.1. Residual hazards**

Hazardous conditions may occur during the bending of materials that must be analysed and prevented. Attention should be paid to the movements of the piece to be bent and the roller while the material is being introduced into the machine as well as during its shaping. Despite the fact that the forward speed of the rollers is slow, there is a risk of entrapment in the extremities between the rollers and the part.

Users of the machine are recommended to handle the part to be bent firmly with one hand and to move the hand according to the progress of the bending operation in order to maintain a safe distance from the rollers.

It is also necessary to prepare the work area to prevent other operators from injuring themselves during operation of the machine.

### **6.2. Counter-productive methods**

Tools or rollers that are not supplied by the manufacturer of the machine, NARGESA S.L., and which have not been specially designed for the MC150B bending machine should never be used .

### **6.3. Other recommendations**

- Use gloves for handling the machine and during the bending processes.
- Wear EC-approved goggles and protective boots
- Handle the material at the ends, and never around the area being bent
- Do not work without the protection devices that the machine is fitted with
- Ensure that there is a safe distance between the machine and the operator



7. ASSEMBLING OF THE ROLLERS

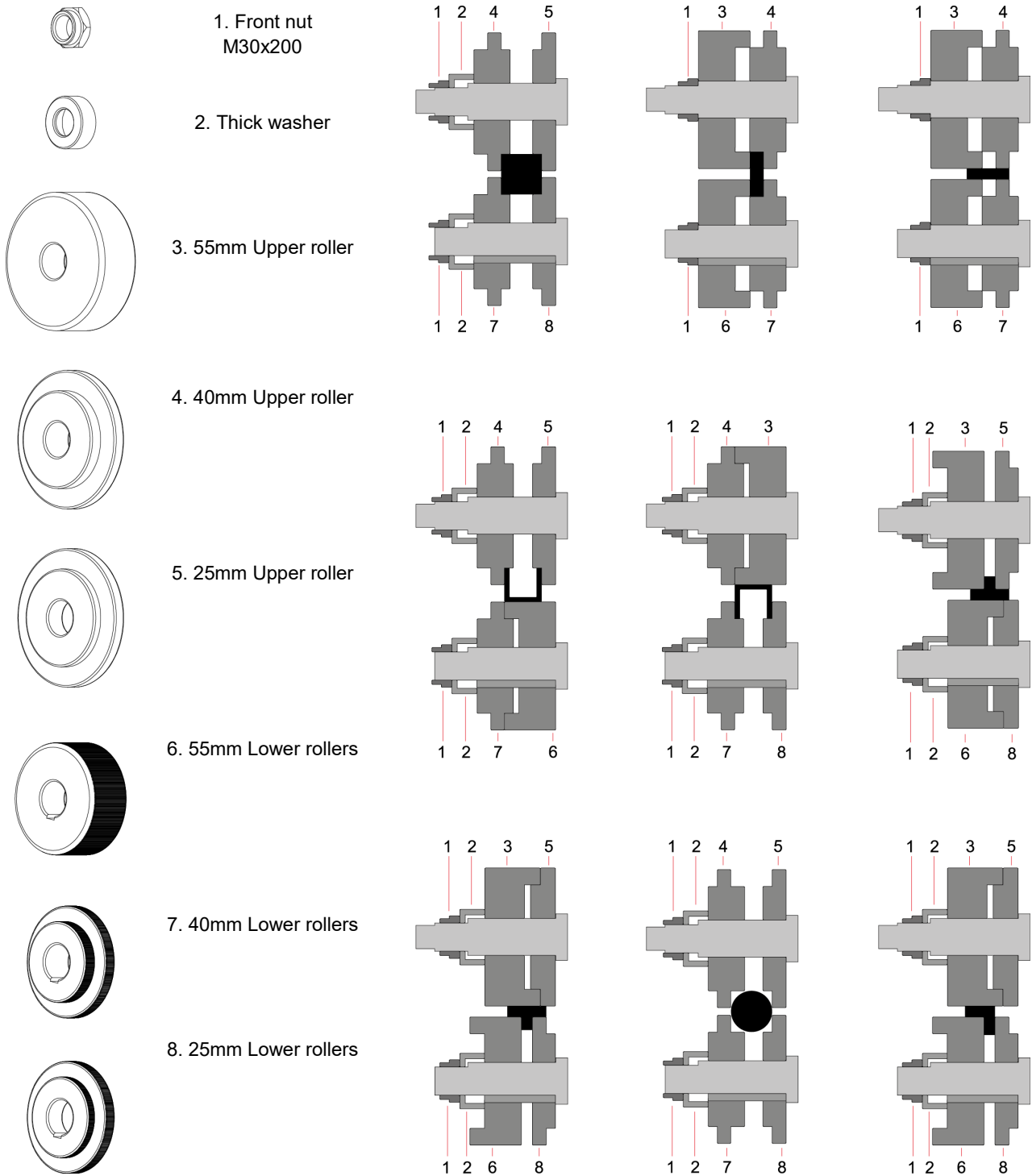

Figure 12. Nomenclature of the rollers and assembly

**IMPORTANT NOTE:**

The clamping nut of the rollers should never be tightened with a wrench and only by hand. If pipe rollers are being used, the nuts must be loose.











## 7.1. Bending capacity



Profile	MC150B		MC200		MC400		MC200H	
	Measures	Min. radius	Measures	Min. radius	Measures	Min. radius	Measures	Min. radius
	50 x 8	300	50 x 10	300	50 x 10	250	60 x 10	200
	60 x 20	200	80 x 20	150	80 x 20	150	80 x 20	150
	25 x 25	200	30 x 30	200	30 x 30	150	30 x 30	150
	40 x 40 x 3	350	50 x 50 x 3	700	50 x 50 x 3	600	50 x 50 x 3	450
	40	200	40	200	40	150	40	200
	40	250	40	250	40	200	40	250
	50	200	60	300	60	225	60	225
	50	250	60	300	60	225	60	225
	40	500	40	420	40	200	40	300
	25	180	30	150	30	150	30	150
	40 x 2 *	300	40 x 2 *	250	40 x 2 *	200	40 x 2 *	200
	50,8 x 3 *	600	63,5 x 3 *	500	63,5 x 3 *	450	76,2 x 2 *	500
	= 2" x 3 *	600	= 2"1/2 x 3 *	500	= 2"1/2 x 3 *	450	= 3" x 2 *	500



\* Optional rollers



	<b>MC550 · MC550NC · MC550CNC</b>		<b>MC650 · MC650NC · MC650CNC</b>	
Profile	Measures	Min. radius	Measures	Min. radius
	60x15	400	100x15	1250
	60x8	200		
	50x15	350		
	50x10	175	80x20	450
	40x8	150	60x15	300
	30x5	110	50x15	155
	25x5	105	20x10	140
	100x20	250	120x20	250
	80x20	200	100x25	350
	80x15	180	80x20	200
	40x40	400	400	300
	30x30	180	180	280
	25x25	175	175	200
	20x20	150	150	150
	15x15	150	150	
	60x60x3	800	70x70x4	750
	50x50x3	600	60x60x3	750
	35x35x3	200	40x40x3	300
	70x30x3	500	80x40x3	500
	60x30x3	400	60x30x3	300
	50x30x3	250	50x30x3	250
	60x60x7	300	80*	500
	50x50x6	250	70	400
	40x40x5	200	60	200
			40	150
	60x60x7	500	80*	500
	50x50x6	400	60	400
	40x40x5	300	40	150
	60x60x7	350		
	50x50x6	300	60x8	450
	40x40x5	250	40x6	250

**SECTION BENDING MACHINE MC150B**



Profile	MC550 · MC550NC · MC550CNC		MC650 · MC650NC · MC650CNC	
	Measures	Min. radius	Measures	Min. radius
	50x5	750*	50x5	750*
	40x4	500*	40x4	500*
	40	300	50	300
	35	250	40	200
	30	200	25	175
	20	130		
			101,6x3,5* (=4"x3)	500
			100x3*	500
			88,9x4* (=3"SCH)	700
			35x2*	120
			20x1,5*	115

## 8. OPTIONAL ACCESSORIES

The bending machine has been designed for bending all kinds of profiles irrespective of their shape.

The standard rolls included as standard on the bending machine allow the configuration of all kinds of handrails, angles, square, round pipes, etc., thanks to their multiple configurations.

In order to facilitate the bending of certain more delicate materials that require a very good surface finish or to facilitate the bending of more common sections, NARGESA has designed a series of rollers that can be purchased at an official dealership or by directly by contacting NARGESA S.L.

Besides the accessories shown below, NARGESA also designs special rollers upon specific request for customers .

### Set of treated steel rollers



Set of 3 treated steel rollers for steel round pipe or stainless steel, thickness bigger than 2 mm.

When pipe sizes are smaller, two sizes are included in the same roller.

Eg. (25 + 30) o (1/2" + 1"1/4")

*Always clean up the rollers well before using stainless steel not to get the pipe contaminated.*

Tube size in mm		
Reference	Dimensions	Weight
140-08-01-RHT0007	(25 + 30)	17,00 Kg
140-08-01-RHT0006	(20 + 35)	16,50 Kg
140-08-01-RHT0001	40	16,60 Kg
140-08-01-RHT0002	50	14,25 Kg
140-08-01-RHT0003	60	11,10 Kg
For Schedule pipe		
140-08-01-RHISOT0006	(3/4" + 1/2") = (26,9 + 21,3 mm)	17,70 Kg
140-08-01-RHISOT0007	(1" + 3/8") = (33,7 + 17,2 mm)	17,00 Kg
140-08-01-RHISOT0002	1" 1/4 = 42,4 mm	16,00 Kg
140-08-01-RHISOT0003	1" 1/2 = 48,3 mm	14,40 Kg
140-08-01-RHISOT0004	2" = 60,3 mm	11,15 Kg
For inches pipe		
140-08-01-RHWT-00001	(1/2" + 1"1/4") = (12,700 + 31,751 mm)	18,00 Kg
140-08-01-RHWT-00002	(1" + 3/4") = (25,401 + 19,051 mm)	18,50 Kg
140-08-01-RHWT-00003	1"1/2 = 38,101 mm	17,25 Kg
140-08-01-RHWT-00004	2" = 50,802 mm	13,60 Kg
140-08-01-RHWT-00005	2"1/2 = 63,502 mm	9,75 Kg

## Set of Sustarin rollers



Set of 3 Sustarin rollers for stainless steel pipes, aluminium and delicate materials for thickness smaller than 2.5 mm.

When pipe sizes are smaller, two sizes are included in the same roller.

Eg. (25 + 30)

*Sustarin rollers do not spoil or contaminate the pipe.*

**For any other size or profile please ask the manufacturer.**

Tube size in mm		
Reference	Dimensions	Weight
140-08-01-RI0007	(25 + 30)	1,40 Kg
140-08-01-RI0001	(20 + 35)	1,40 Kg
140-08-01-RI0010	33	1,50 Kg
140-08-01-RI0004	40	1,40 Kg
140-08-01-RI0003	43	1,30 Kg
140-08-01-RI0006	50	1,20 Kg
140-08-01-RI0008	60	0,90 Kg
For inches pipe		
140-08-01-RIW-00001	(1/2" + 1"1/4") = (12,700 + 31,751 mm)	1,80 Kg
140-08-01-RIW-00002	(1" + 3/4") = (25,401 + 19,051 mm)	1,50 Kg
140-08-01-RIW-00003	1"1/2 = 38,101 mm	1,40 Kg
140-08-01-RIW-00004	2" = 50,802 mm	1,20 Kg
140-08-01-RIW-00005	2"1/2 = 63,502 mm	0,90 Kg

## **Technical annex**

### **MC150B Bending Machine**

---

General parts diagram

Electric box · THREEPHASE MACHINE

Electric map · THREEPHASE MACHINE

Electric box · SINGLEPHASE MACHINE







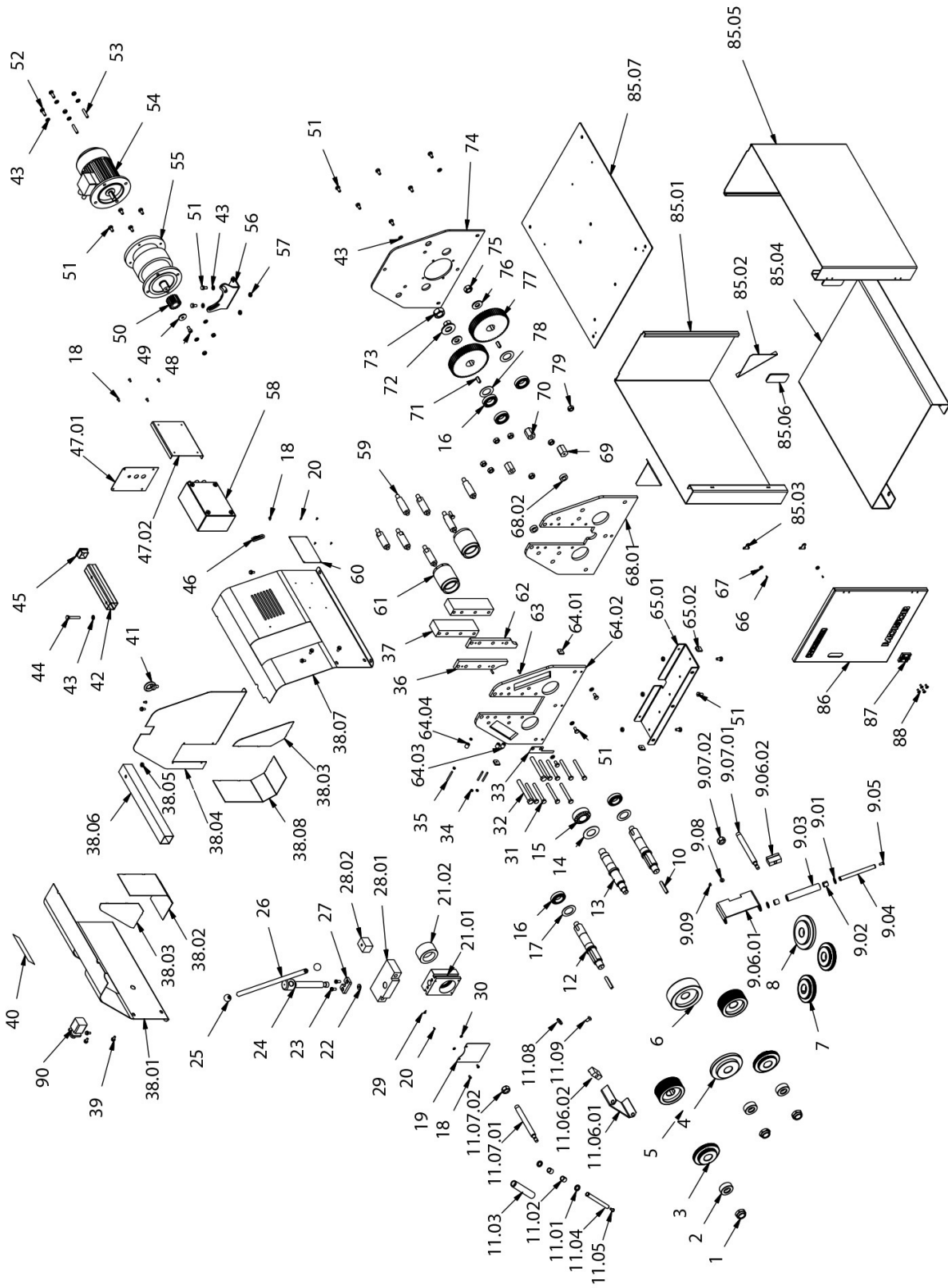













Electric map · SINGLEPHASE MACHINE

Control botonera



















A1. General parts diagram











































Nº ORDEN	DIBUJO	DESCRIPCION	Nº PLANO	PIEZAS POR MAQUINA
1		Tuerca Delantera	120-08-01-00001	3
2		Arandela de Vaso	120-08-01-00002	3
3		Rodillo Inferior De 40	120-08-02-00161	2
4		Rodillo Superior De 40	120-08-02-00164	1
5		Rodillo Inferior De 55	120-08-02-00162	2
6		Rodillo Superior De 55	120-08-02-00163	1
7		Rodillo Inferior De 25	120-08-02-00160	2
8		Rodillo Superior De 25	120-08-02-00165	1
9		Conjunto Final Enderezador Derecho MC150B	130-08-07-00017	1
10		Chaveta Paralela DIN 6885AB 12X8X70	030-D6885AB-00002	2
11		Conjunto Final Enderezador Izquierdo MC150B	130-08-07-00022	1
12		Ejes Inferiores MC150B	120-08-07-00075	2
13		Eje Superior MC150B	120-08-07-00078	1
14		Arandela Tapa Cojinete Superior Delantero	120-08-07-00009	1
15		Rodamiento de rodillos cónico 33208 40X80X32	030-CJ-00007	1
16		Rodamiento de rodillos cónico 32008 40x68x19	030-CJ-00002	5
17		Arandela Separacion Delantera Ejes Inferiores	120-08-07-00021	2
18		Tornillo Allen ISO 7380 M6X12	020-I7380-M6X12	8
19		Chapa Seguridad Trancha	120-08-07-00049	1
20		Remache De Clavo DIN 7337 De Al D3x8	020-D7337-3X8	5

**SECTION BENDING MACHINE MC150B**

<b>N° ORDEN</b>	<b>DIBUJO</b>	<b>DESCRIPCION</b>	<b>N° PLANO</b>	<b>PIEZAS POR MAQUINA</b>
21		Conjunto Soldado Buje Movil	130-08-07-00009	1
22		Disco De Apoyo	120-08-07-00057	1
23		Tornillo Allen Cabeza Reducida DIN 6912 M10X20	020-D6912-M10x20	2
24		Tornillo Ajuste Superior	120-08-07-00082	1
25		Pomo Esfera Ranurada D32 M8 Con Inserto Metalico	031-POMH-00004	2
26		Palanca Accionamiento	120-08-02-00073	1
27		Tapa Fijacion Tornillo Ajuste	120-08-07-00046	1
28		Pletina Superior Tope Trancha	130-08-07-00008	1
29		Flecha Indicadora MC150B	120-08-07-00059	1
30		Arandela DIN 125 B M6	020-D125B-M6	2
31		Tornillo DIN 931 M12X110	020-D931-M12x110	8
32		Tornillo DIN 931 M16X130	020-D931-M16X130	2
33		Regla MC150B	120-08-07-00060	1
34		Tuerca DIN 934 M6	020-D934-M6	4
35		Esparrago Allen DIN 913 M6X55	020-D913-M6X55	3
36		Guia Izquierda Buje Superior	120-08-07-00102	1
37		Pletina De Refuerzo	120-08-07-00014	2
38		Conjunto Soldado Tapa Trasera	130-08-07-00020	1
39		Tornillo DIN 6921 M8x16	020-D6921-M8X16	9

Nº ORDEN	DIBUJO	DESCRIPCION	Nº PLANO	PIEZAS POR MAQUINA
40		Adhesivo Pictogramas Peligro MC200 / MC200H	122-CAL-0802-004	1
41		Cancamo Macho DIN 580 M12 Zincado	020-D580-M12-ZN	1
42		Prolongacion Pie Trasero	120-08-07-00041	1
43		Arandela DIN 125 B M10	020-D125B-M10	14
44		Tornillo DIN 933 M10x65	020-D933-M10X65	1
45		Tapon Plastico Para Tubo Cuadrado 45X45	031-TAP-00018	1
46		Sujecion Mandos	120-08-03-00024	1
47		Conjunto Soldado Soporte Cuadro Electrico	130-08-07-00005	1
48		Tornillo Allen DIN 912 M10X20	020-D912-M10X20	1
49		Arandela Motor	120-08-07-00108	1
50		Piñon De Ataque Z17 M3 B40	120-08-07-00031	1
51		Tornillo DIN 933 M10X20	020-D933-M10X20	18
52		Tornillo DIN 933 M10X30	020-D933-M10X30	3
53		Esparrago Allen DIN 913 M10X50	020-D913-M10X50	2
54		Motor Electrico 0.75KW A 1400 rpm BRIDA B5	050-ME-00007	1
55		Reductor Cicloidal Ratio 71 BLD12-71 Brida Motor B5 0.75Kw	050-RTC-00001	1
56		Soporte Motorreductor Mesa	120-08-07-00064	1
57		Tuerca DIN 934 M10	020-D934-M10	9
58		Kit Instalacion Electrica MC150B	050-KIE-0807-001	1

**SECTION BENDING MACHINE MC150B**

<b>N° ORDEN</b>	<b>DIBUJO</b>	<b>DESCRIPCION</b>	<b>N° PLANO</b>	<b>PIEZAS POR MAQUINA</b>
59		Mecha Separadora Cilindrica	120-08-07-00015	7
60		Placa Caracteristicas MC150B	122-PLC-0807-001	1
61		Buje Inferior	120-08-07-00098	2
62		Guia Derecha Buje Superior	120-08-07-00103	1
63		Pasador Cilindrico Con Rosca Int. DIN7979/D D6X20	030-D7979D-00008	2
64		Conjunto Soldado Placa Frontal	130-08-07-00019	1
65		Conjunto Base Inferior MC150B	130-08-07-00018	1
66		Tornillo Allen DIN 7991 M3X8	020-D7991-M3x8	2
67		Base Magnetica D16X4.5 Agujero Avellanado	031-BM-00003	2
68		Conjunto Placa Intermedia MC150B	130-08-07-00021	1
69		Mecha Inferior Brida Motor	120-08-07-00018	1
70		Mecha Brida Motor	120-08-07-00019	2
71		Chaveta Paralela DIN6885AB 12X8X32	030-D6885AB-00003	2
72		Arandela Guesa Buje Superior Atras	120-08-07-00024	1
73		Tuerca Posterior	120-08-01-00043	1
74		Placa Trasera	120-08-07-00094	1
75		Tuerca DIN 934 M22	020-D934-M22	2
76		Arandela Eje Inferior Apriete Engranaje	120-08-07-00076	2
77		Engranaje Z60 M3 B35	120-08-07-00022	2

<b>N° ORDEN</b>	<b>DIBUJO</b>	<b>DESCRIPCION</b>	<b>N° PLANO</b>	<b>PIEZAS POR MAQUINA</b>
78		Arandela Separacion Trasera Ejes Inferiores	120-08-07-00104	2
79		Tuerca DIN 934 M16	020-D934-M16	7
85		Mesa Bancada	130-08-07-00026	1
86		Puerta Mesa	120-08-07-00111	1
87		Bisagra De Plastico 30 Entre Centros	031-BP-00001	2
88		Tornillo Allen DIN 7991 M6X16	020-D7991-M6X16	8
90		Interruptor General KG10AK300	050-IG-00001	1

A2. Electric box · THREEPHASE MACHINE

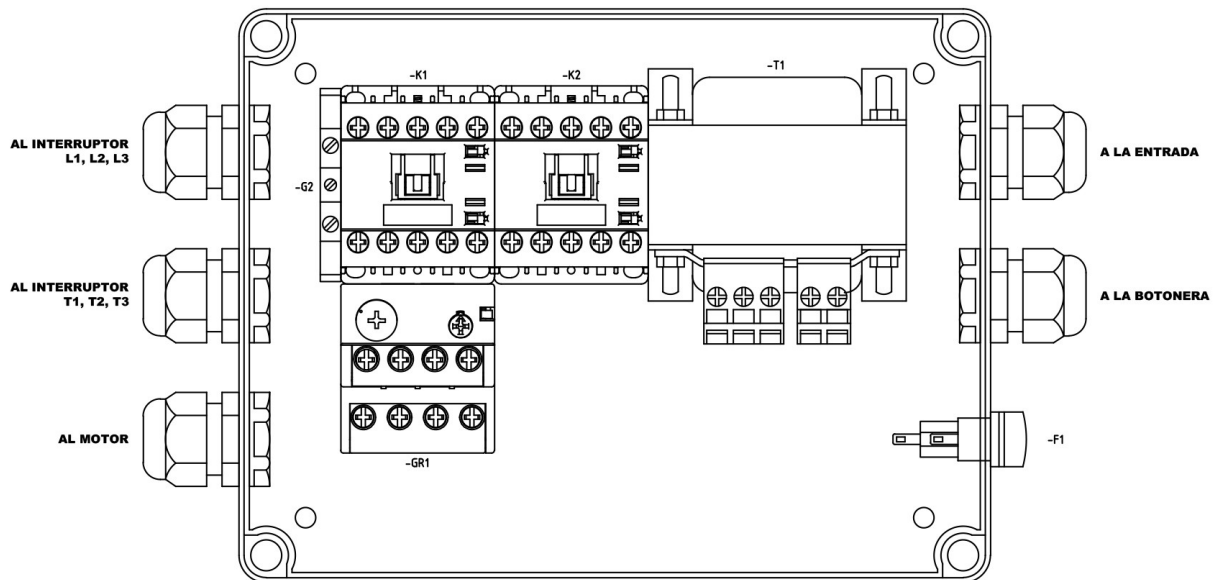

A3. Electric map · THREEPHASE MACHINE

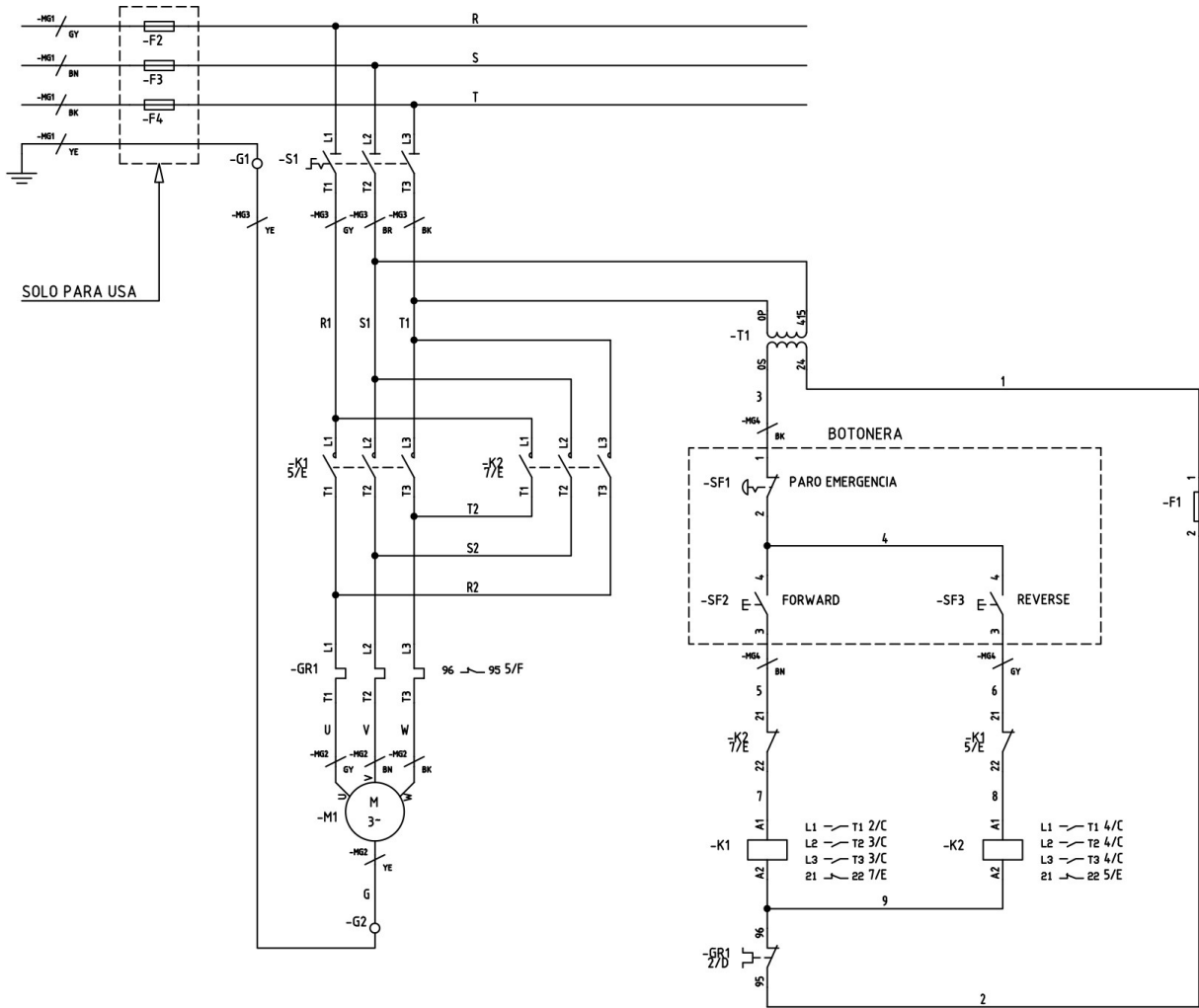

A4. Electric box · SINGLEPHASE MACHINE

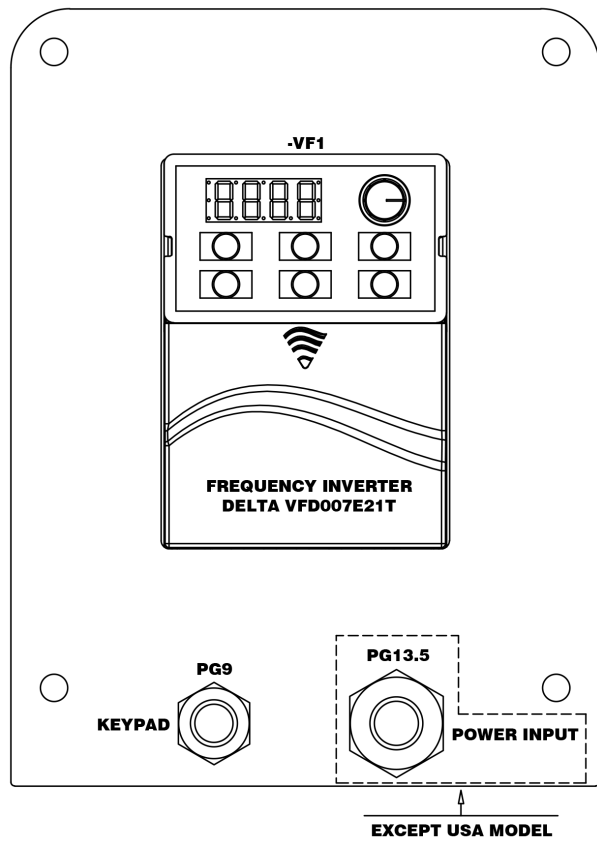
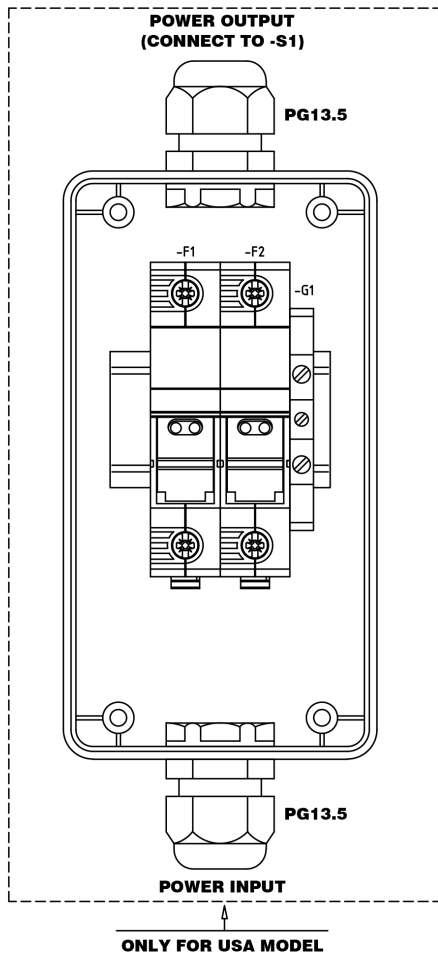



A5. Electric map · SINGLEPHASE MACHINE

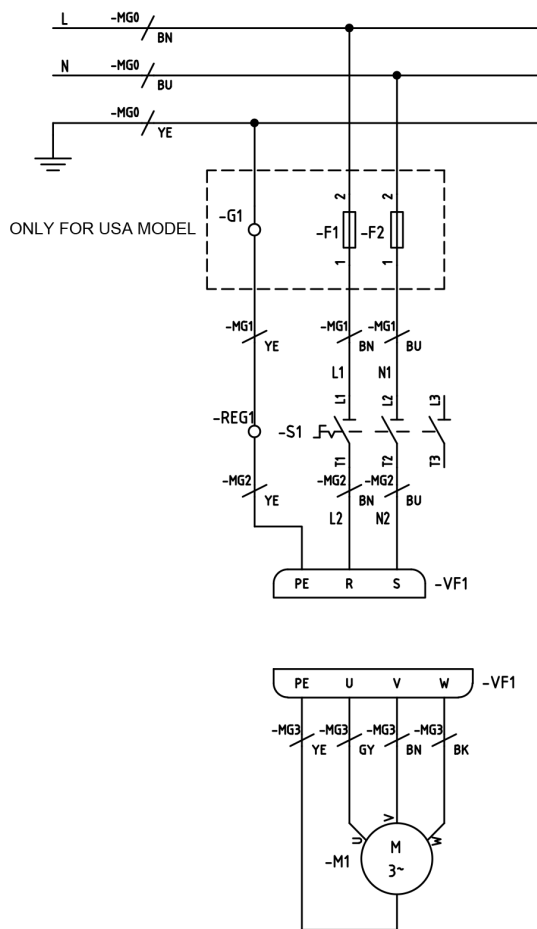

VF1 : FREQUENCY INVERTER  
M1 : ROLLER MOTOR

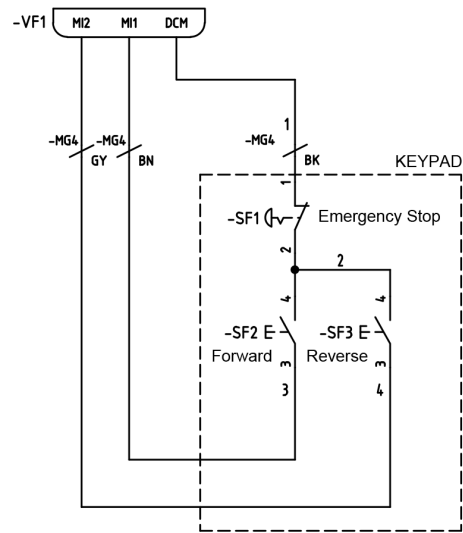

A6. Keypad control

**SF1 : BUTTON PANEL EMERGENCY STOP**  
**SF2 : BUTTON PANEL FORWARD**  
**SF3 : BUTTON PANEL REVERSE**

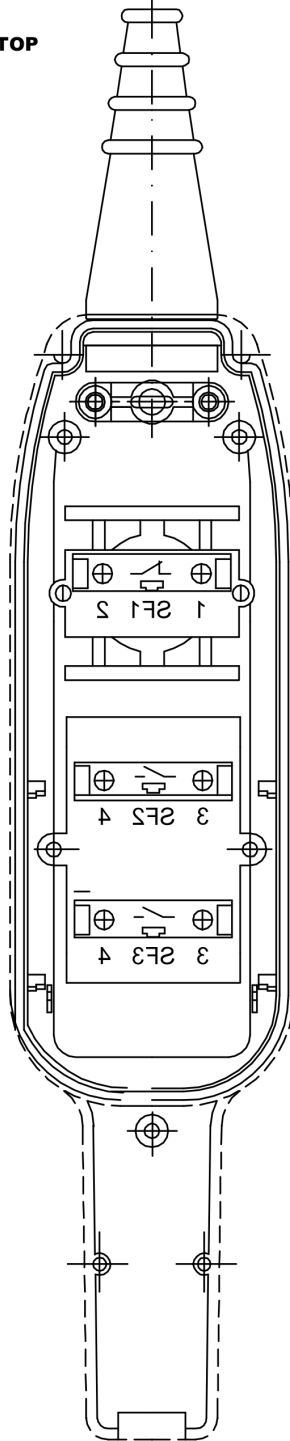

# OUR RANGE OF MACHINERY



IRON WORKERS



SECTION BENDING MACHINES



NON-MANDREL PIPE BENDER



HORIZONTAL PRESS BRAKE



TWISTING/SCROLL BENDING MACHINES



HYDRAULIC PRESS BRAKES



HYDRAULIC SHEAR MACHINES



GAS FORGES



IRON EMBOSSING MACHINES



END WROUGHT IRON MACHINES



BROACHING MACHINES



POWER HAMMERS



PRESSES FOR LOCKS