

N NARGESA®

SECTION BENDING MACHINES

MC200



50 years
manufacturing industrial machinery

SECTION BENDING MACHINES

The pipe and section bending machines Nargesa with two or three traction rollers, either hydraulic or mechanic system are ideal for making all kinds of bends, curves, shapes on different pipes and profiles no matter the material to be use, aluminium, stainless steel, mild steel, copper, galvanized pipe...

GET A QUOTE

Please complete the following form. We'll contact you in less than 24 hours.
Business days.

HOW IT WORKS VIDEO

Video on how the machine works.



SOME OF OUR REMARKABLE CUSTOMERS



OUR RANGE OF BENDING MACHINES



MC150B

- > Two drive rollers.
- > Diameter of axes: 40 mm.
- > Useful axes length: 74 mm.
- > Center distance between lower axes: 230 mm.
- > Maximum capacity for bending round pipe: 2 inches or 50 mm.



MC200

- > Two drive rollers.
- > Diameter of axes: 40 mm.
- > Useful axes length: 74 mm.
- > Center distance between lower axes: 286 mm.
- > Maximum capacity for bending round pipe: 2 1/2 inches or 63.5 mm.



MC400

- > Three drive rollers.
- > Diameter of axes: 40 mm.
- > Useful axes length: 80 mm.
- > Maximum capacity for bending round pipe: 2 1/2 inches or 63.5 mm.
- > Independent bending regulation of the lower rollers.



MC200H

- > Two drive rollers.
- > Diameter of axes: 40 mm.
- > Useful axes length: 74 mm.
- > Center distance between lower axes: 286 mm
- > Maximum capacity for bending round pipe: 3 inches or 76.2 mm.













MC650

- > Three drive rollers.
- > Diameter of axes: Inferiores 65 mm / Superior 80 mm.
- > Useful axes length: 130 mm.
- > Maximum capacity for bending round pipe: 4 inches or 101,6 mm.
- > Independent bending regulation of the lower rollers.

BENDING CAPACITY

Sizes indicated in the following chart are estimated, they are closely related to pipe harness and quality.



	MC150B		MC200		MC400		MC200H		MC650	
Section	Size	Min. Radius	Size	Min. Radius	Size	Min. Radius	Size	Min. Radius	Size	Min. Radius
	50x10	300	50x10	300	50x10	250	60x10	200	100x20 80x20	1250 450
	60x20	200	80x20	150	80x20	150	80x20	150	100x25 80x20	350 200
	25x25	200	30x30	200	30x30	150	30x30	150	45x45 25x25	300 200
	50x50x3	700	50x50x3	600	50x50x3	600	50x50x3	450	70x70x4 40x40x3	750 350
	40	200	40	200	40	150	40	200	80* 70 40	500 400 150
	40	250	40	250	40	200	40	250	80* 60 40	500 400 150
	50	200	60	300	60	225	60	225	120* 100* 80	600 600 400
	50	250	60	300	60	225	60	225	120* 100* 80	700 700 400
	40	500	40	420	40	200	40	300	70 40	600 250
	25	180	30	150	30	150	30	150	50 25	300 175
	40x2* 50,8x3* = 2"x3*	300 600 600	40x2* 63,5x3* = 2 1/2"x3*	250 500 500	40x2* 63,5x3* = 2 1/2"x3*	200 450 450	40x2* 76,2x2* = 3"x2*	200 500 500	88,9x4* 101,6x3* = 4"x3*	700 700 700

* Optional rollers

TECHNICAL FEATURES

Section Bending Machine MC200 NARGESA fabricated in steel, two traction rollers, pinion transmissions, treated and rectified. Maximum capacity for bending round pipe: 2" 1/2 inches or 63,5 mm.

- > Diameter of axes: 40 mm.
- > Useful axes length: 74 mm.
- > Center distance between lower axes: 286 mm.
- > Maximum capacity for bending round pipe: 2 1/2 inch or 63.5 mm.
- > Bending regulation by means of the upper axis which permits to make bending operations in big pipes and profiles diameters without any distortion.
- > It's equipped with 9 standard rollers and washers by means of which you can make all kinds of profiles.
- > Millimeter scale in the upper axis to regulate bending.
- > Vertical and Horizontal working position in the same table.
- > Side corrector rollers to rule the bending operation and make spiral bending.
- > Motor Power: 1,1 KW / 1,5 HP.
- > Voltage supply: 3 phased 230/400 V.
- > For single phased machines, request quotation.
- > Rollers speed: 8 RPM.

** All our products are manufactured in our facilities in Spain. The hydraulic and electrical components are all standard from the best leading European trademarks, with technical assistance all over the world: Rexroth, Bosch, Roquet, Schneider Electric, LG, Telemecanique, Pizzato etc...*

OUTSIDE DIMENSIONS

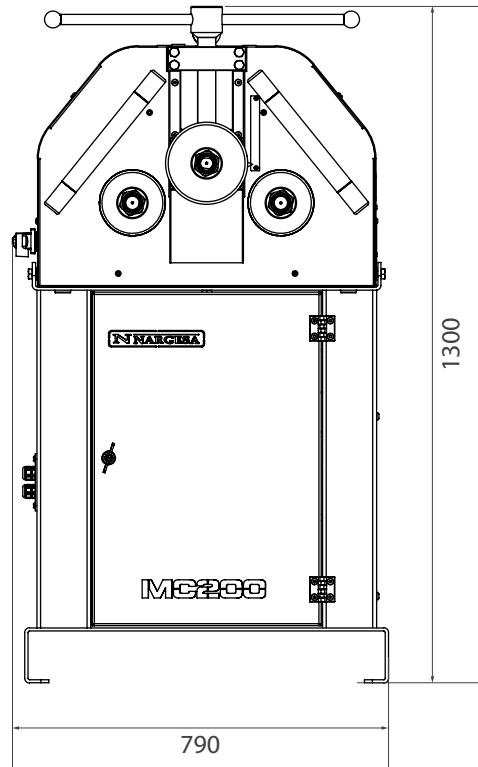
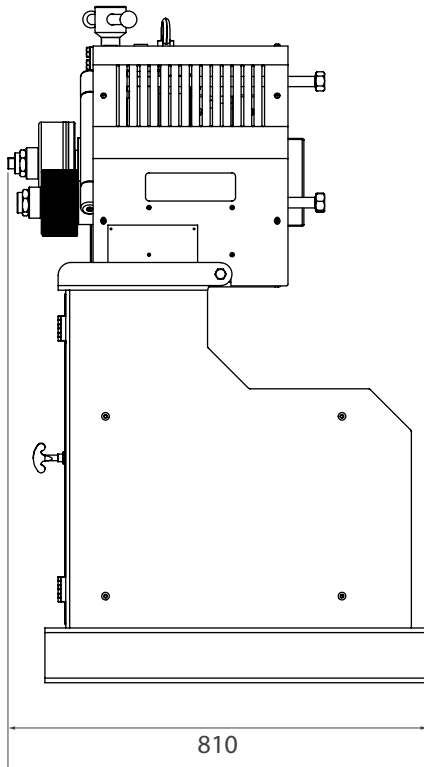

PACKAGING CHARACTERISTICS

- Tariff Item Code: 84622990
- Lower bench palletized to easily transport the machine to the workplace or store it in case of lacking space.
- The machine is shipped fully assembled.
- Pallet made of steel and 3 layer cardboard box suitable for seafreight.
- Optional: Fumigated wooden box NIMF15.

MC200

Width	700 mm
Depth	830 mm
Height	1380 mm
Volume	0.80 m ³
Net Weight	320 Kg.
Gross Weight	335 Kg.

STANDARD ACCESSORIES SUPPLIED WITH THE MACHINE

Standard rollers MC200



It's equipped with 9 standard pieces, by means of which the user can work all kinds of profiles. Square, rectangular pipe, solid round and square bars. U Profile, T profile, angle, flat bar, edged flat bar... Adjustable rollers, by washers with the size of profile or pipe which allows us to make bending to different pipe or profile sizes.



Steel rollers F1140 treated and rectified.

Assembling of the rollers

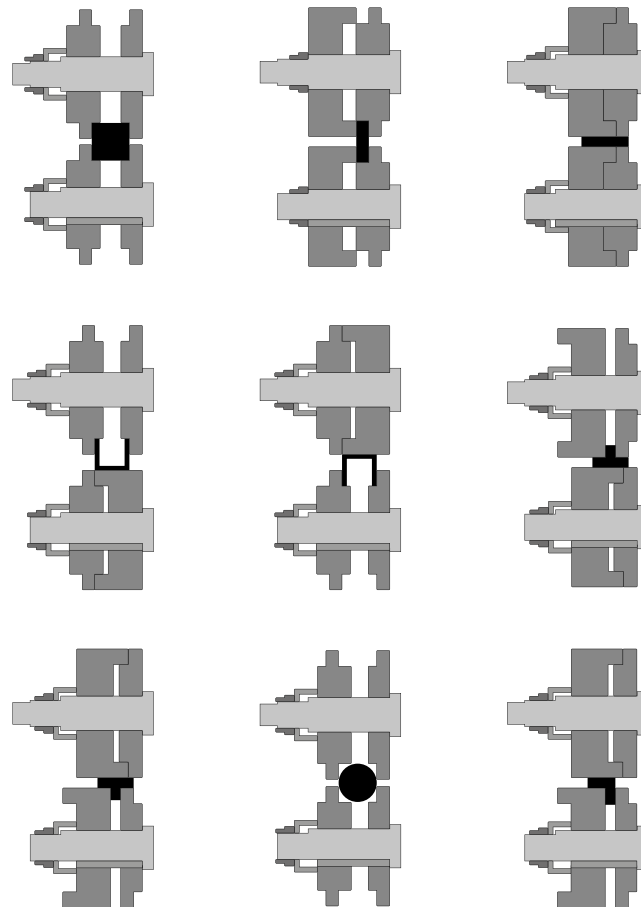

OPTIONAL ACCESSORIES

High precision digital radius gauge



REF: 140-MED08-00001

The **High precision digital radius gauge** allows the user to have a direct and immediate reading of inner and outer radius in a range from 55 to 11.250 millimeters or from 2" to 443" inches.

The High precision digital radius gauge measures radii in spherical objects such as tubes, profiles and pipes in a quick and accurate way. It is really fast and easy to use! It indicates the inner or outer radius of the part we are bending *without removing it from the machine and without needing to previously draw and cut a guide template.*

This Digital arc meter allows the direct and immediate reading of the values of the inner or outer radius in a wide range of bends.

- > **Comfort:** No need to prepare and cut a template to know the radius of a bend, it is not necessary to remove the part from the machine to measure it either. The digital radius gauge makes the job quicker and easier.
- > **Easy to use:** Its use is simple and the measurement process is very fast. We only have to place the digital radius gauge on the internal or external part of the curve and it will automatically show the value.
- > **Multi-material:** This tool is suitable for any kind of solid and consistent materials like steel, wood or plastic shapes.
- > **High precision:** Its error tolerance over the radius is 0,01mm. Precision will depend on the surface quality of the material to measure.
- > **Application scope:** This digital radius gauge is supplied with three different high precision arc meters. The use of either one or other arch meter offers a measurement range swinging from 55 to 11.250 millimeters and from 2" to 443" inches.
- > **LCD digital screen:** Comfortable reading of all data and low power consumption.
- > **Practical:** It is small and light, we can easily use it for different measurements. It is comfortable, reliable and long lasting.
- > **Storage:** We deliver it inside a stainless briefcase, with an inner foam protection to keep it safe and protect the arc meter when it is not in use. It is comfortable to carry and shock-resistant.
- > **Two units of measure:** We can select either millimeters or inches just by pressing a button.
- > **Perfect for wide radii:** Unlike other manufacturers, the High Precision Arc Meter Nargesa can measure radii up to 12m with maximum precision. For bigger radii, please consult the manufacturer.
- > **Ideal for smaller radii:** The great touch sensor length allows its use even when the inner radius to measure is very tiny.

TECHNICAL SPECIFICATIONS

- > Measurement scope: From 55 to 11.250 millimeters or from 2" to 443" Inches.
- > Error tolerance over the touch sensor: $\Delta L = 0.02\text{mm}$
- > Error tolerance over the radius: $\Delta R = (0.01 * R)\text{mm}$
- > Power supply: 3V CR2032 Lithium battery
- > Working temperature: $0 \pm 40^\circ\text{C}$
- > Storage and transport temperature: $-20^\circ\text{C} - 60^\circ\text{C}$
- > Relative humidity: =80%

Arc meters supplied with the High precision digital radius gauge

100 Measurement arc



The 100mm High precision arc meter is supplied along with the High precision digital radius indicator.

This tool is attached to the arc meter to measure internal or external radii, amongst the following ranges:

Minimum radius: 55mm or 2"

Maximum radius: 625mm or 25"

200 Measurement arc



The 200mm High precision arc meter is supplied along with the High precision digital radius indicator.

This tool is attached to the arc meter to measure internal or external radii, amongst the following ranges:

Minimum radius: 125mm or 5"

Maximum radius: 2.500mm or 99"

300 Measurement arc



The 300mm High precision arc meter is supplied along with the High precision digital radius indicator.

This tool is attached to the arc meter to measure internal or external radii, amongst the following ranges:

Minimum radius: 475mm or 18"

Maximum radius: 11.250mm or 443"

Treated steel rollers · MC150B · MC200 · MC200H · MC400



Rollers made of Steel F-1140 and treated to 62 Rc. Suitable for bending all kind of round steel or stainless steel pipes.

*Always clean up the rollers well before using stainless steel not to get the pipe contaminated.
When the tube measurements are small, two measurements are added on the same roller.*



Tube size in mm		
Reference	Dimensions	Weight
140-08-01-RHT0007	(25 + 30)	17,00 Kg.
140-08-01-RHT0006	(20 + 35)	16,50 Kg.
140-08-01-RHT0001	40	16,60 Kg.
140-08-01-RHT0002	50	14,25 Kg.
140-08-01-RHT0003	60	11,10 Kg.
For Schedule pipe		
140-08-01-RHISOT0006	$(3/4" + 1/2") = (26,9 + 21,3 \text{ mm})$	17,70 Kg.
140-08-01-RHISOT0007	$(1" + 3/8") = (33,7 + 17,2 \text{ mm})$	17,00 Kg.
140-08-01-RHISOT0002	$1" 1/4 = 42,4 \text{ mm}$	16,00 Kg.
140-08-01-RHISOT0003	$1" 1/2 = 48,3 \text{ mm}$	14,40 Kg.
140-08-01-RHISOT0004	$2" = 60,3 \text{ mm}$	11,15 Kg.
For Whitworth inches pipe		
140-08-01-RHWT-00001	$(1/2" + 1" 1/4) = (12,700 + 31,751 \text{ mm})$	18,00 Kg.
140-08-01-RHWT-00002	$(1" + 3/4") = (25,401 + 19,051 \text{ mm})$	18,50 Kg.
140-08-01-RHWT-00003	$1" 1/2 = 38,101 \text{ mm}$	17,25 Kg.
140-08-01-RHWT-00004	$2" = 50,802 \text{ mm}$	13,60 Kg.
140-08-01-RHWT-00005	$2" 1/2 = 63,502 \text{ mm}$	9,75 Kg.

Sustarin Rollers · MC150B · MC200 · MC200H · MC400



Rollers made of Sustarin to bend round stainless steel pipes, aluminium and delicate materials with thickness not bigger than 2.5mm.

Sustarin rollers do not damage nor get the pipe contaminated.

When the tube measurements are small, two measurements are added on the same roller.

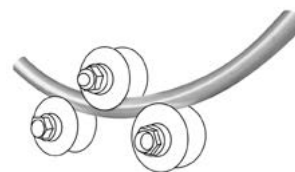

Tube size in mm		
Reference	Dimensions	Weight
140-08-01-RI0007	(25 + 30)	1,40 Kg.
140-08-01-R10001	(20 + 35)	1,40 Kg.
140-08-01-RI0010	33	1,50 Kg.
140-08-01-RI0004	40	1,40 Kg.
140-08-01-RI0003	43	1,30 Kg.
140-08-01-RI0006	50	1,20 KG.
140-08-01-RI0008	60	0,90 KG.
For Whitworth inches pipe		
140-08-01-RIW-00001	$(1/2''+1''1/4) = (12,700 + 31,751 \text{ mm})$	1,80 Kg.
140-08-01-RIW-00002	$(1''+3/4'') = (25,401 + 19,051 \text{ mm})$	1,50 Kg.
140-08-01-RIW-00003	$1''1/2 = 38,101 \text{ mm}$	1,40 Kg.
140-08-01-RIW-00004	$2'' = 50,802 \text{ mm}$	1,20 Kg.
140-08-01-RIW-00005	$2''1/2 = 63,502 \text{ mm}$	0,90 Kg.

OUR RANGE OF MACHINERY



IRON WORKERS



SECTION BENDING
MACHINES



NON-MANDREL PIPE
BENDER



HORIZONTAL PRESS
BRAKES



TWISTING/SCROLL
BENDING MACHINES



HYDRAULIC PRESS
BRAKES



HYDRAULIC SHEAR
MACHINES



GAS FORGES



IRON EMBOSSING
MACHINES



END WROUGHT IRON
MACHINES



BROACHING MACHINES



POWER HAMMERS



PRESSES FOR LOCKS

WARRANTY

Nargesa machines have 3 years warranty provided that the customer registers it in our website. Otherwise it would be only one year warranty. This one encloses any manufacturing default all along these 3 years for components. Any misuse is excluded from this condition. Labor, back and forth shipping and any eventual repair, are not included in this warranty.

Partner companies.



Airpharm

SHIPMENT EVERYWHERE

Nargesa will arrange transport up to final destination, whenever the customers asks for so. There is also the possibility for the customer to arrange the shipment himself with his own agency.

TECHNICAL ASSISTANCE

All our customers have access to technical support quickly and efficiently.

90% of incidences are solved out on the phone, mail, Skype or video-conferencing in less than 24hours. In case of needing presencial technical assistance, we may as well send a technician to the customer's facilities.

Follow us on

PRADA NARGESA, S.L.

Ctra. De Garrigàs a Sant Miquel s/n
17476 Palau de Santa Eulalia (Girona) Spain
Tel. +34 972 568 085

www.nargesa.com

nargesa@nargesa.com



This information might undergo changes